

# Real Time Clock Module with I<sup>2</sup>C Bus

AB-RTCMC-32.768kHz-B5GA-S3

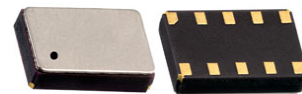

RoHS/RoHS II compliant



3.7 x 2.5 x 0.9 mm

Moisture Sensitivity Level: MSL=1

## FEATURES:

- With state-of-the-art RTC Technology by Micro Crystal AG
- RTC module with built-in crystal oscillating at 32.768 kHz
- 400kHz two-wire I2C interface
- Wide Interface operating voltage: 1.8 – 5.5 V
- Wide clock operating voltage: 1.2 – 5.5 V
- Low power consumption: 250 nA typ @ 3.0V / 25°C
- Provides year, month, day, weekday, hours, minutes, seconds
- Alarm and Timer functions
- Century flag
- Low voltage detector, internal power on reset
- Programmable clock output for peripheral devices (32.768 kHz, 1024 Hz, 32 Hz, 1 Hz)
- I2C slave address: read A3h, write A2h
- Small and compact package size: 3.7 x 2.5 x 0.9 mm. RoHS-compliant and 100% leadfree

## APPLICATIONS:

- Wide range in communication & measuring equipment
- Commercial & Industrial applications
- Automotive electronics applications
- Wireless communications
- PDA and Palm Pilots
- Credit Cards with Security Technology

## STANDARD SPECIFICATIONS:

### Absolute Maximum Ratings

Parameters	Min.	Typ.	Max.	Units	Notes
Supply Voltage ( $V_{DD}$ )	-0.5		+6.5	V	>GND / < $V_{DD}$
Supply Current ( $I_{DD}$ ; $I_{SS}$ )	-50		+50	mA	$V_{DD}$ Pin
Input Voltage ( $V_I$ )	$V_{SS}-0.5$		$V_{DD}+0.5$	V	Input Pin
Output Voltage ( $V_O$ )	$V_{SS}-0.5$		$V_{DD}+0.5$	V	$\overline{INT}$ Pin
DC Input Current ( $I_I$ )	-10		+10	mA	
DC Output Current ( $I_O$ )	-10		+10	mA	
Operating Temperature Range ( $T_{OPR}$ )	-40		+85	°C	
Storage Temperature ( $T_{STO}$ )	-55		+125	°C	Stored as bare product

### Frequency Characteristics

Parameters	Min.	Typ.	Max.	Units	Notes
Frequency Accuracy ( $\Delta F/F$ )		±10	±20	ppm	$T_{AMB}=+25^{\circ}C$ ; $V_{DD}=3.0V$
Frequency vs Voltage ( $\Delta F/V$ )		±0.8	±1.5	ppm/V	$T_{AMB}=+25^{\circ}C$ ; $V_{DD}=1.8\sim 5.5V$
Frequency vs Temperature ( $\Delta F/T_{OPR}$ )	-0.035ppm/°C <sup>2</sup> ( $T_{OPR}-T_O$ ) <sup>2</sup> ±10%			ppm	$T_{REF}=+25^{\circ}C$ ; $V_{DD}=3.0V$
Turnover Temperature ( $T_O$ )	+20	+25	+30	°C	
Aging (first year)	-3		+3	ppm	$T_{AMB}=+25^{\circ}C$
Start-up Time ( $T_{START}$ )		350	500	ms	$T_{AMB}=+25^{\circ}C$
CLKOUT duty cycle	40	50	60	%	$T_{AMB}=+25^{\circ}C$



## Static Characteristics

Parameters		Min.	Typ.	Max.	Units	Notes
<b>Supplies</b>						
Supply Voltage (V <sub>DD</sub> )		1.2		5.5	V	I <sup>2</sup> C bus inactive T <sub>AMB</sub> =+25°C
		1.8		5.5		I <sup>2</sup> C bus active f <sub>SCL</sub> = 400kHz
		V <sub>LOW</sub>		5.5		For clock data integrity T <sub>AMB</sub> =+25°C
Current Consumption (I <sub>DD0</sub> )	f <sub>SCL</sub> = 400kHz			800	μA	I <sup>2</sup> C bus active
	f <sub>SCL</sub> = 100kHz			200		
Current Consumption (I <sub>DD</sub> ) <sup>1) 2) 3)</sup>	V <sub>DD</sub> = 5.0V		275	550	nA	I <sup>2</sup> C bus inactive(f <sub>SCL</sub> =0Hz) CLKOUT disabled T <sub>AMB</sub> =+25°C
	V <sub>DD</sub> = 3.0V		250	500		
	V <sub>DD</sub> = 2.0V		225	450		
Current Consumption (I <sub>DD</sub> ) <sup>1) 2) 3)</sup>	V <sub>DD</sub> = 5.0V		500	750	nA	I <sup>2</sup> C bus inactive(f <sub>SCL</sub> =0Hz) CLKOUT disabled T <sub>AMB</sub> =-40 ~ +85°C
	V <sub>DD</sub> = 3.0V		400	650		
	V <sub>DD</sub> = 2.0V		400	600		
Current Consumption (I <sub>DD32k</sub> ) <sup>3)</sup>	V <sub>DD</sub> = 5.0V		2.5	3.4	μA	I <sup>2</sup> C bus inactive(f <sub>SCL</sub> =0Hz) CLKOUT enabled (32.768kHz) Load=7.5pF / T <sub>AMB</sub> = +25°C
	V <sub>DD</sub> = 3.0V		1.5	2.2		
	V <sub>DD</sub> = 2.0V		1.1	1.6		
<b>Input</b>						
LOW Level Input Voltage (V <sub>IL</sub> )		V <sub>SS</sub> -0.5		30%* V <sub>DD</sub>	V	
HIGH Level Input Voltage (V <sub>IH</sub> )		70%* V <sub>DD</sub>		V <sub>DD</sub> +0.5	V	
Input Leakage Current (I <sub>L</sub> )		-1		+1	μA	V <sub>I</sub> =V <sub>DD</sub> or V <sub>SS</sub>
Input Capacitance (C <sub>I</sub> ) <sup>4)</sup>				7	pF	
<b>Output</b>						
HIGH Level Output Current (I <sub>OH</sub> )	Pin: CLKOUT			1	mA	V <sub>OH</sub> = 4.6V; V <sub>DD</sub> = 5.0V
LOW Level Output Current (I <sub>OL</sub> )	Pin: SDA			-3	mA	V <sub>OL</sub> = 0.4V; V <sub>DD</sub> = 5.0V
	Pin: $\overline{\text{INT}}$			-1		
	Pin: CLKOUT			-1		
Output Leakage Current (I <sub>LO</sub> )		-1	0	+1	μA	V <sub>O</sub> = V <sub>DD</sub> or V <sub>SS</sub>
<b>Voltage Detector</b>						
Low Voltage (V <sub>LOW</sub> )			0.9	1.0	V	T <sub>AMB</sub> =+25°C

1) Timer source clock = 1/60 Hz.

2) CLKOUT disabled (FE = 0 or CLKOE = 0).

3) V<sub>IL</sub> and V<sub>IH</sub> with an input voltage swing of V<sub>SS</sub> to V<sub>DD</sub>.

4) Tested on sample basis.

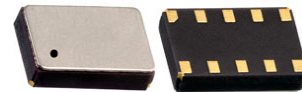

## I<sup>2</sup>C Interface Dynamic Characteristics

All timing values are valid within the operating supply voltage range and references to  $V_{IL}$  and  $V_{IH}$  with an input voltage swing from  $V_{SS}$  and  $V_{DD}$ .

Parameters	Min.	Typ.	Max.	Units
SCL clock frequency ( $f_{SCL}$ )			400	kHz
Hold time (repeated) START condition ( $t_{HD,STA}$ )	0.6			$\mu$ s
Startup time for repeated START condition ( $t_{SU,STA}$ )	0.6			$\mu$ s
LOW period of SCL clock ( $t_{LOW}$ )	1.3			$\mu$ s
HIGH period of SCL clock ( $t_{HIGH}$ )	0.6			$\mu$ s
Bus free time between STOP and START condition ( $t_{BUF}$ )	1.3			$\mu$ s
Rise time of both SDA and SCL signals ( $t_r$ )			0.3	$\mu$ s
Fall time of both SDA and SCL signals ( $t_f$ )			0.3	$\mu$ s
Capacitive load for each bus line ( $C_b$ )			400	pF
Data setup time ( $t_{SU,DAT}$ )	100			ns
Data hold time ( $t_{HD,DAT}$ )	0			ns
Setup time for STOP condition ( $t_{SU,STO}$ )	0.6			$\mu$ s
Spike pulse width ( $t_{w(spike)}$ )			50	ns

## I<sup>2</sup>C Interface Timing Characteristics

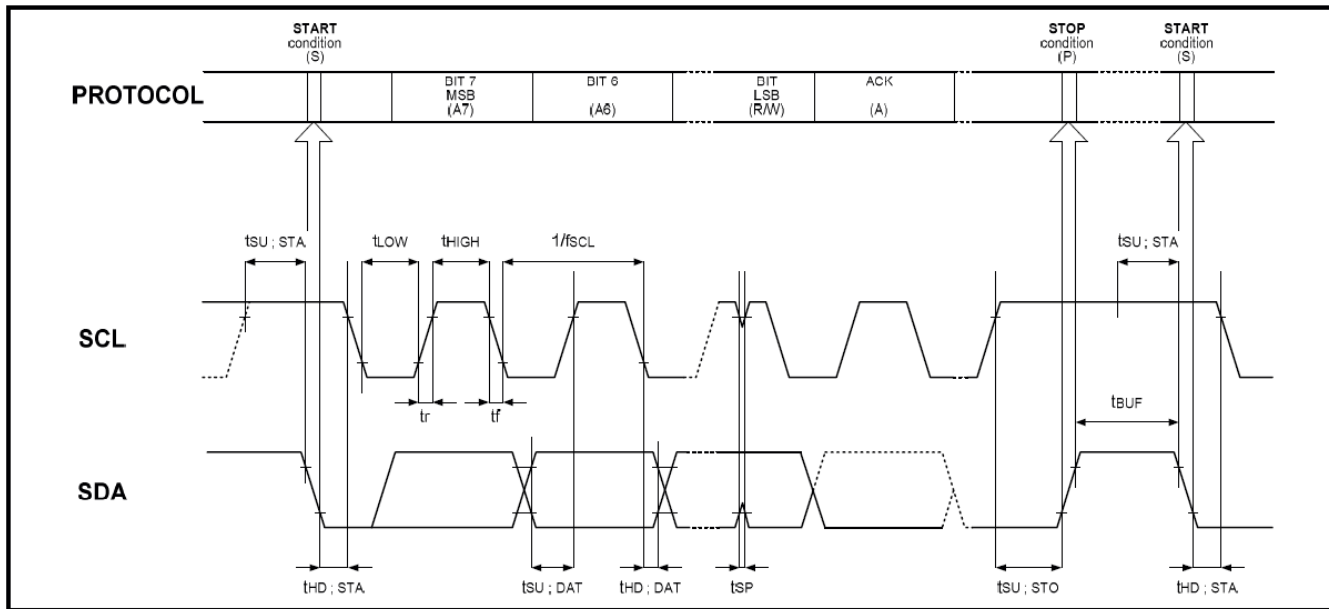

Note:

The I<sup>2</sup>C BUS access time between a START and a START condition or between a START and a STOP condition to this device must be less than one second.

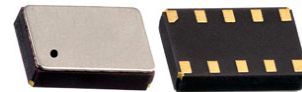

3.7 x 2.5 x 0.9 mm

AB-RTCMC-32.768kHz-B5GA-S3



RoHS/RoHS II compliant

## PART IDENTIFICATIONS:

AB-RTCMC-32.768 kHz-B5GA-S3-

### Packaging

Blank: Bulk

T: 1000pcs/reel

## OUTLINE DIMENSIONS:

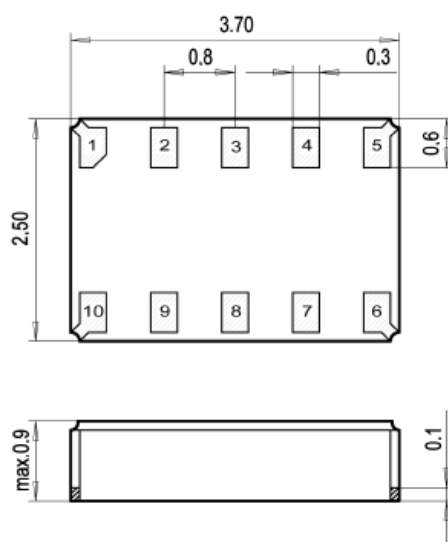

### Recommended Land Pattern

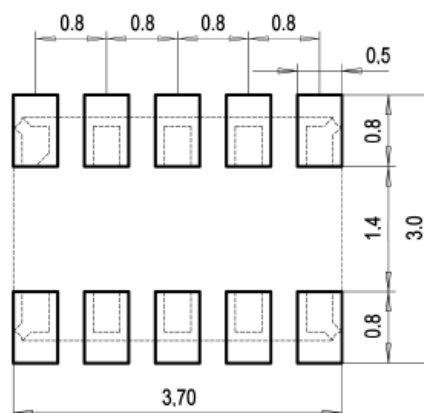

Dimensions: mm

## PIN DESCRIPTIONS:

Pin No.	Pin Name	Function
1	CLKOE	CLKOUT enable/disable pin; enable is active HIGH; tie to GND when not using CLKOUT
2	V <sub>DD</sub>	Positive supply voltage
3	CLKOUT	Clock Output pin; push-pull
4	SCL	Serial Clock Input pin; requires pull-up resistor
5	SDA	Serial Data Input-Output pin; open-drain; requires pull-up resistor
6	$\overline{\text{INT}}$	Interrupt Output pin; open-drain; active LOW
7	V <sub>SS</sub>	Ground
8	N.C.	Not Connected
9	N.C.	Not Connected
10	N.C.	Not Connected

# Real Time Clock Module with I<sup>2</sup>C Bus

AB-RTCMC-32.768kHz-B5GA-S3



RoHS/RoHS II compliant

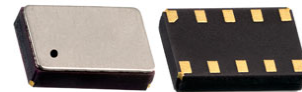

3.7 x 2.5 x 0.9 mm

## BLOCK DIAGRAM:

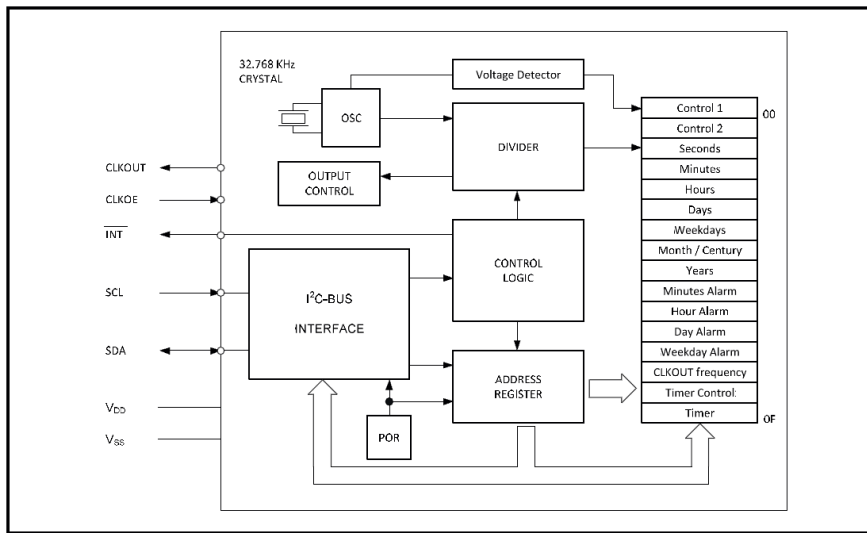

## RECOMMENDED REFLOW PROFILE:

Maximum Reflow Conditions in accordance with IPC/JEDEC J-STD-020C “Pb-free”

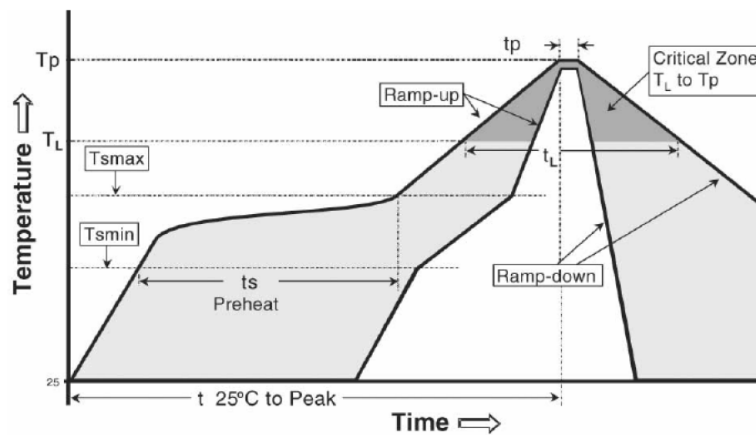

Temperature	Conditions	Units
Average Ramp-up Rate ( $T_{Smax}$ to $T_p$ )	3°C/second max	°C/s
Ramp Down Rate ( $T_{cool}$ )	6°C/second max	°C/s
Time 25°C to Peak Temperature ( $T_{to-peak}$ )	8 minutes max	m
<b>Preheat</b>		
Temperature Min ( $T_{Smin}$ )	150	°C
Temperature Max ( $T_{Smax}$ )	200	°C
Time $T_{Smin}$ to $T_{Smax}$ ( $t_s$ )	60 ~ 180	sec
<b>Time Above Liquidus</b>		
Temperature Liquidus ( $T_L$ )	217	°C
Time above Liquidus ( $t_L$ )	60 ~ 150	sec
<b>Peak Temperature</b>		
Peak Temperature ( $T_p$ )	260	°C
Time within 5°C of Peak Temperature ( $t_p$ )	20 ~ 40	sec

# Real Time Clock Module with I<sup>2</sup>C Bus

AB-RTCMC-32.768kHz-B5GA-S3



RoHS/RoHS II compliant

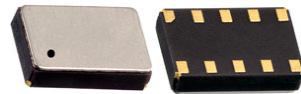

3.7 x 2.5 x 0.9 mm

## TAPE & REEL:

T = 1000pcs/reel

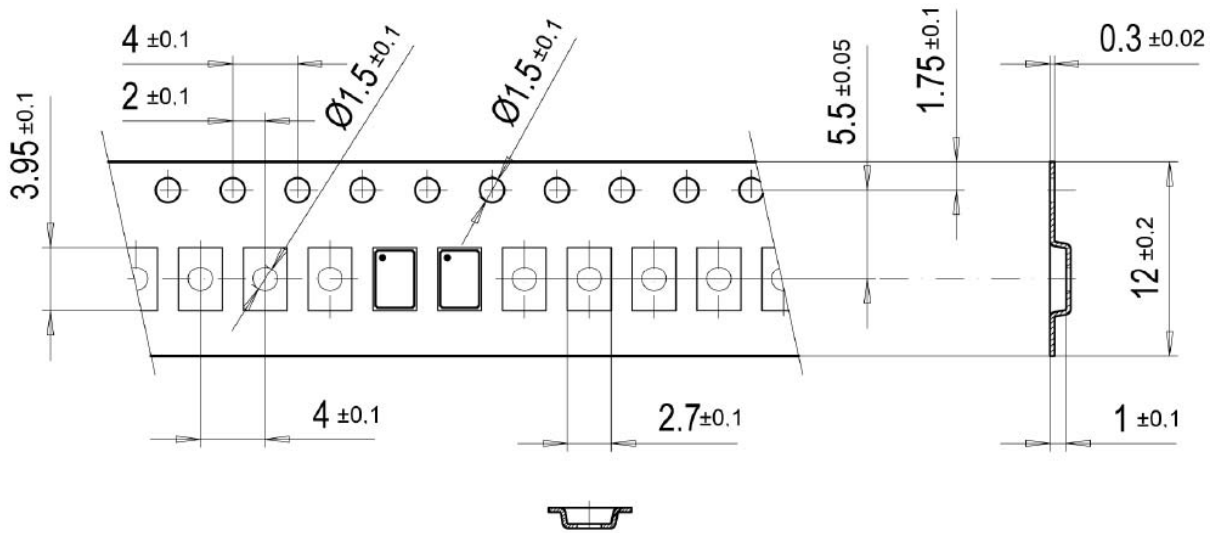

 User Direction of Feed

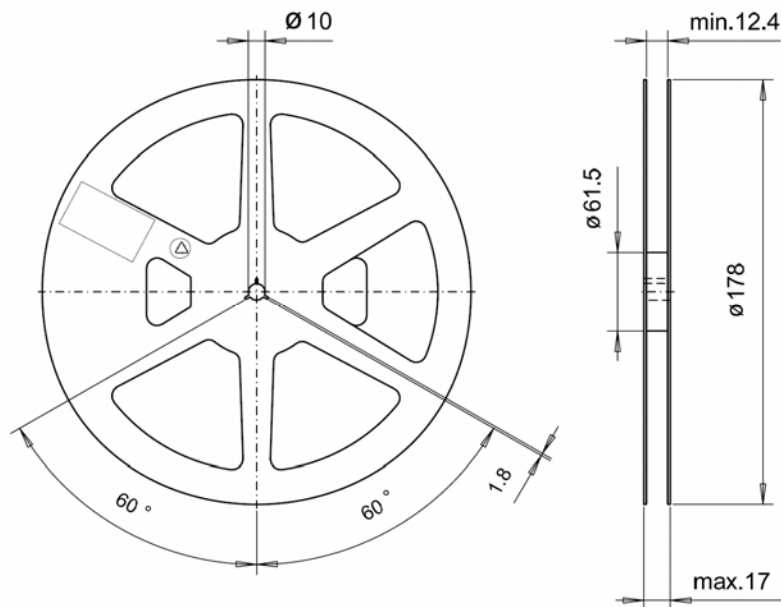

Dimension: mm

**ATTENTION:** Abracon LLC's products are COTS – Commercial-Off-The-Shelf products; suitable for Commercial, Industrial and, where designated, Automotive Applications. Abracon's products are not specifically designed for Military, Aviation, Aerospace, Life-dependent Medical applications or any application requiring high reliability where component failure could result in loss of life and/or property. For applications requiring high reliability and/or presenting an extreme operating environment, written consent and authorization from Abracon LLC is required. Please contact Abracon LLC for more information.



5101 Hidden Creek Ln Spicewood TX 78669  
 Phone: 512-371-6159 | Fax: 512-351-8858  
 For terms and conditions of sales, please visit:  
[www.abracon.com](http://www.abracon.com)

REVISED: 11.28.2018

ABRACON IS  
 ISO9001-2015  
 CERTIFIED