

# EC35B 35mm Size Composite Operation Type

Composite operation device that integrates both ring encoder and self return switch

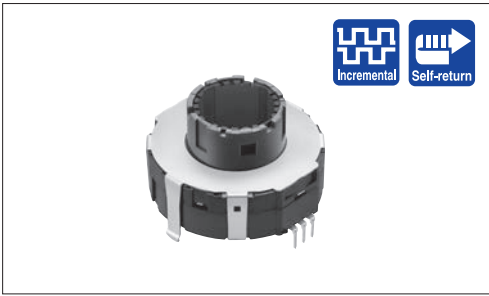

## Typical Specifications



Items		Specifications
Rating		10mA 5V DC
Operating life	Encoder	30,000 cycles
	Self-return switch	15,000 cycles
Operating temperature range		-40°C to +85°C

## Product Line

Actuator length (mm)	Detent torque (mN·m)	Number of detent	Number of pulse	Switch	Minimum order unit (pcs.)		Product No.
					Japan	Export	
21.35	20±10	30	15	Self-return switch	300	600	<b>EC35B154H401</b>

## Packing Specifications

Tray

Number of packages (pcs.)		Export package measurements (mm)
1 case /Japan	1 case /export packing	
300	600	540×360×380

## Dimensions

Style	PC board mounting hole dimensions (Viewed from mounting side)

## Output Wave (Switch 01)

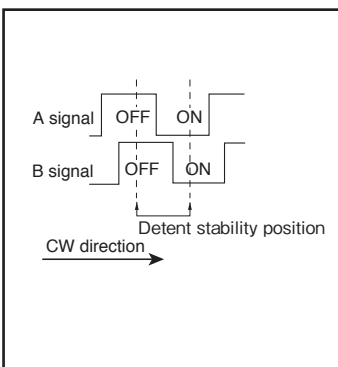



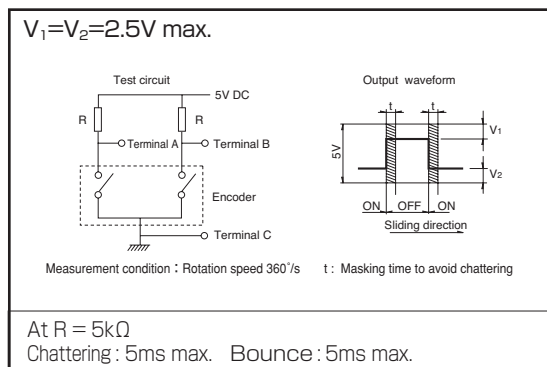



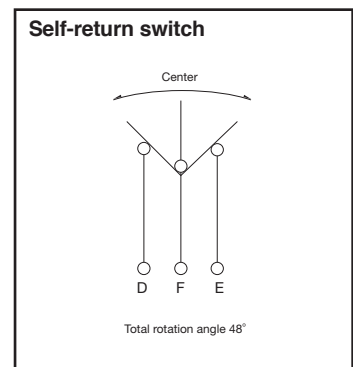











## Sliding Noise (Switch 01)



## Circuit Diagram (Switch 02)



Type		Ring type					
		35mm size		40mm size	45mm size	50mm size	60mm size
Series		EC35CH	EC35B	EC40A	EC45A	EC50A	EC60B
Photo							
Output		Incremental (Three phase A, B and C)	Incremental (Two phase A and B) /Self-return switch	Incremental (Two phase A and B)	Absolute type	Incremental (Two phase A and B)	
Shaft types		Ring type					
Number of pulse / Number of detent		6×ABC/18	15/30	15/30	31 positions	9/18	15/30
Dimensions (mm)	W	35.2	35	40.4	44.5	50.8	62.4
	D	36	37	43	45	50	60
	H	4.5	12.1	9		6.5	7.5
Operating temperature range		-40°C to +90°C		-40°C to +85°C			
Operating life		50,000 cycles		30,000 cycles		40,000 cycles	
Automotive use							
Life cycle (availability)							
Electrical performance	Rating	10mA 5V DC		0.5mA 5V DC		1mA 5V DC	10mA 5V DC
	Max./min. operating current (Resistive load)	10mA / 1mA		—	—	—	—
	Insulation resistance	100MΩ min. 250V DC		10MΩ min. 50V DC		10MΩ min. 250V DC	100MΩ min. 250V DC
	Voltage proof	300V AC for 1minute or 360V AC for 1s		50V AC for 1 minute	50V AC for 1 minute or 60V AC for 2s		300V AC for 1 minute or 360V AC for 1s
Mechanical performance	Detent torque	22±11mN·m (Initial) 18±7mN·m (After reflow)	20±10mN·m	20±11mN·m 40±16mN·m	36±16mN·m	40±14mN·m	40±10mN·m
	Push-pull strength	Push	100N				
		Pull	100N	50N		100N	
Shaft configuration		Ring type					
Terminal type		Insertion					
Switch Specifications	Switch type	—	Self-return switch	—	—	—	—
	Contact arrangement	—	Single pole and double throw	—	—	—	—
	Travel (mm)	—	2.8±0.5	—	—	—	—
	Operating force (N)	—	3.8±1.5	—	—	—	—
	Switch ON position	—	15°±5°	—	—	—	—
	Rotational torque	—	40±25mN·m	—	—	—	—
	Rating	—	10mA 5V DC	—	—	—	—
	Contact resistance	—	200mΩ max.	—	—	—	—
	Operating life	—	15,000 cycles	—	—	—	—
Page		308	310	311	312	313	314

Encoders Soldering Conditions . . . . . 315  
 Encoders Cautions . . . . . 316

#### Note

● Indicates applicability to all products in the series.

## Reference for Manual Soldering

Series	Tip temperature	Soldering time	No. of solders
EC05E, EC09E, EC10E, EC111, EC11B, EC11E, EC11G, EC11K, EC12D, EC12E, EC18A, EC21A, EC28A, EC35A, EC35AH, EC35B, EC40A, EC45A, EC50A, EC60B, EM11B, EM20B, EC21C, EC28C, EC35CH	350°C max.	3s max.	1 time
EC11J	350±10°C	3 <sup>+1</sup> <sub>0</sub> s	2 times

## Reference for Dip Soldering

Series	Preheating		Dip soldering		No. of solders
	Soldering surface temperature	Heating time	Soldering temperature	Soldering time	
EC09E, EC11B, EC111, EC11E, EC11G, EC11K, EC18A, EC21A, EC28A, EC35A, EC35AH, EC35B, EC50A, EC60B	100°C max.	2 min. max.	260±5°C	5±1s	2 times max.
EC10E, EC12D, EC12E, EM11B	100°C max.	1 min. max.	260±5°C	3±1s	2 times max.
EC40A	110°C max.	1 min. max.	260°C max.	10s max.	1 time
EC45A	100°C max.	2 min. max.	260°C max.	5s max.	2 times max.
EM20B	80°C max.	1 min. max.	260°C max.	3s max.	2 times max.

## Example of Reflow Soldering Condition

Temperature profile

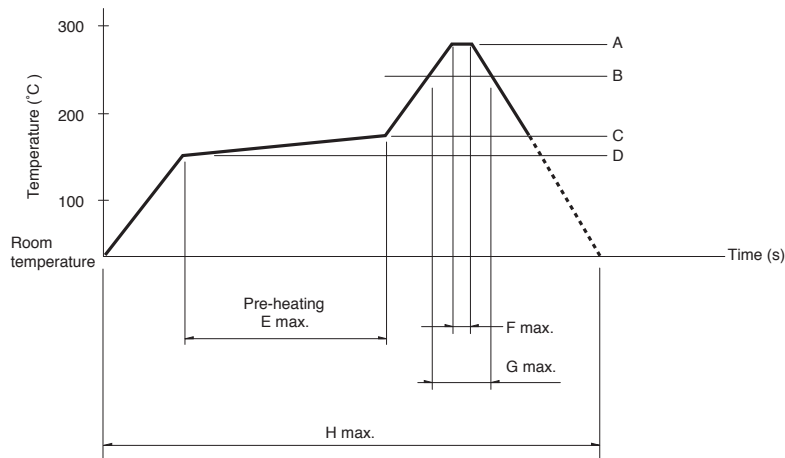

Series	A	B	C	D	E	F	G	H	No. of reflows
EC11J	260°C	230°C	180°C	150°C	2 min. max.	3s	40s	4 min. max.	2 times max.
EC05E	250°C min.	230°C min.	180°C	150°C	60s to 120s	—	30s to 40s	—	2 times max.
EC21C	230°C to 245°C	220°C	200°C	150°C	60s to 120s	—	25s to 60s	300s max.	1 time max.
EC28C, EC35CH	260°C	230°C	180°C	150°C	2 min. min.	3s	40s	230s max.	1 time max.

### 注記

- When using an infrared reflow oven, solder may sometimes not be applied. Be sure to use a hot air reflow oven or a type that uses infrared rays in combination with hot air.
- The temperatures given above are the maximum temperatures at the terminals of the encoder when employing a hot air reflow method. The temperature of the PC board and the surface temperature of the encoder may vary greatly depending on the PC board material, its size and thickness. Ensure that the surface temperature of the encoder does not rise to 250°C or greater.
- Conditions vary to some extent depending on the type of reflow bath used. Be sure to give due consideration to this prior to use.