

## Ultrasonic Distance Measurement Module



Part Number: UM0090-000

Model Number: FA01T04-UM0090-000

### Overview

The Ultrasonic Distance Measurement Module measures the time interval between emitting the ultrasonic pulses and receiving the echo to determine the distance to nearby objects. The distance value is indicated by the pulse width of output signals. Advanced signal processing technique is used in this module to enhance the measurement reliability.

### Features

- Digital output
- Small blind zone
- Rapid response time

### Applications

- UAV
- Robot
- Height measurement
- Smart street light
- Industrial Safety
- Autonomous delivery vehicle

### Dimensions (Unit: mm)

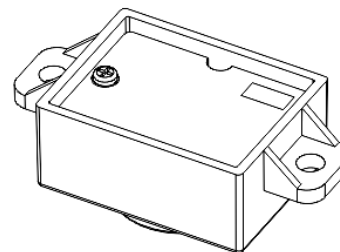
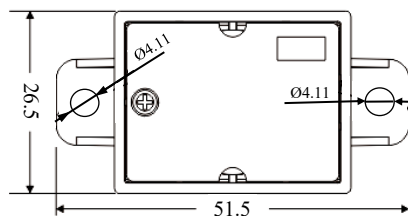
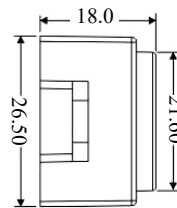
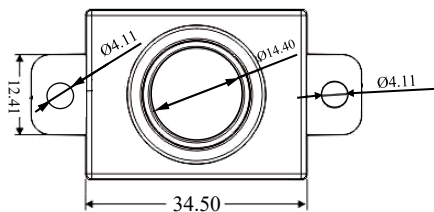
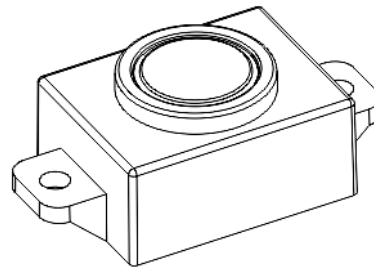
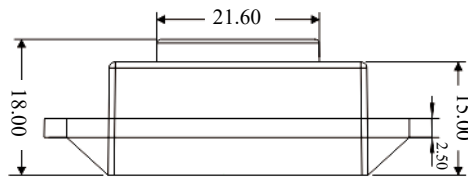

#### TENTATIVE RELEASE:

This specification is based on design objectives and is strictly Preliminary and subject to change. Test data may exist, but this specification is subject to change based on the results of additional testing and evaluation. Application specific specifications will be produced for approval prior to production product being released.

<u>Part No.</u>	<u>Rev</u>	<u>Title</u>	<u>Sheet No.</u>
UM0090-000	A3	Ultrasonic Distance Measurement Module	1 of 5

## Electrical Specifications

Theory	Ultrasonic
<b>Properties</b>	
Measuring Range	17 ~ 300cm (object: flat surface)
Frequency	58kHz
Resolution	<1cm
Response Time	<1ms
Power-up delay	≤1s
Blind zone	17cm
Detect cycle	Every 10ms
Reading Update Frequency	50Hz (Every 20ms)
<b>Output Format</b>	
Output	Measured distance via serial port (unit: cm)
Trigger mode	Low Level, pulse width ≥50us
<b>Rated Operating Condition</b>	
Working environment	Indoors/Outdoors
Operation Temperature	-40 ~ +80 °C
Storage Temperature	-40 ~ +85 °C
Relative humidity	≤95% (No condensation)
<b>Power Supply</b>	
Power supply voltage	5V DC
Working current	≤ 10mA

**TENTATIVE RELEASE:**

This specification is based on design objectives and is strictly Preliminary and subject to change. Test data may exist, but this specification is subject to change based on the results of additional testing and evaluation. Application specific specifications will be produced for approval prior to production product being released.

<u>Part No.</u>	<u>Rev</u>	<u>Title</u>	<u>Sheet No.</u>
UM0090-000	A3	Ultrasonic Distance Measurement Module	2 of 5

## Assembly Diagram

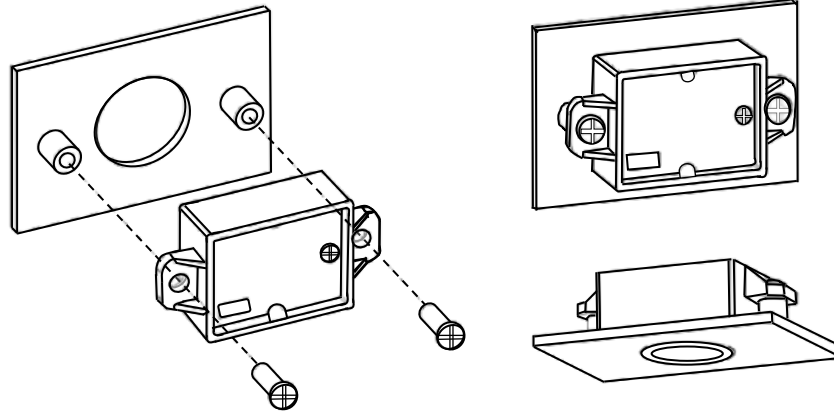

## Response Curves

### Horizontal

Horizontal Envelope

Unit: cm      Curves; round bar, 7.5cm

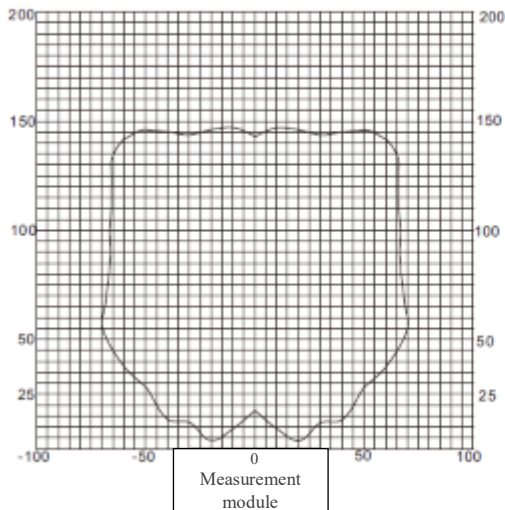

Note: The inner area of the arc or ultrasonic waves can be sensed to Ø7.5cm round bar area

### Vertical

Vertical Envelope

Unit: cm      Curves; round bar, 7.5cm

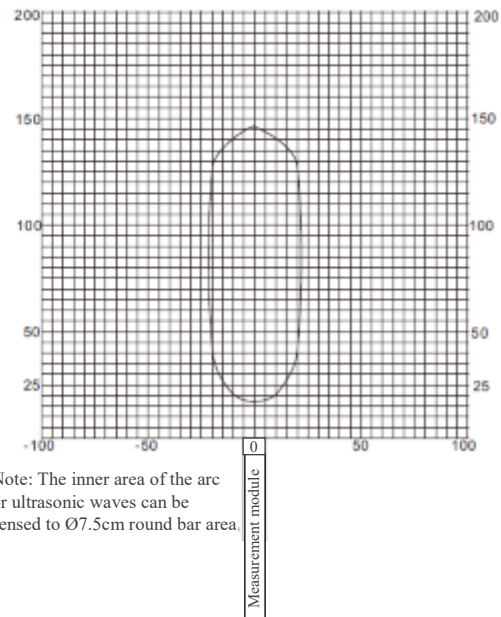

Note: The inner area of the arc or ultrasonic waves can be sensed to Ø7.5cm round bar area.

#### TENTATIVE RELEASE:

This specification is based on design objectives and is strictly Preliminary and subject to change. Test data may exist, but this specification is subject to change based on the results of additional testing and evaluation. Application specific specifications will be produced for approval prior to production product being released.

<u>Part No.</u>	<u>Rev</u>	<u>Title</u>	<u>Sheet No.</u>
UM0090-000	A3	Ultrasonic Distance Measurement Module	3 of 5

## Output Protocol

### Interface Definition:

A 4 pin XH1.0 terminal is used for output, which is defined in the following diagram. The module goes into dormant state after power up. It can be woken up by a low pulse longer than 50us and output distance value which is in the range of 17-300cm. When the measurement is completed, the module automatically enters a dormant state until it is woken up again by a low pulse longer than 50us.

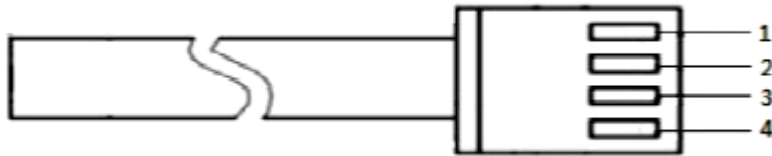

Pin No.	Function of pin	Lead Wire Color	Remark
1	VCC	Red	DC 5V
2	GND	Black	GND
3	OUTPUT	White	Level output
4	RX	Yellow	Level output

### TENTATIVE RELEASE:

This specification is based on design objectives and is strictly Preliminary and subject to change. Test data may exist, but this specification is subject to change based on the results of additional testing and evaluation. Application specific specifications will be produced for approval prior to production product being released.

<u>Part No.</u>	<u>Rev</u>	<u>Title</u>	<u>Sheet No.</u>
UM0090-000	A3	Ultrasonic Distance Measurement Module	4 of 5

## UART (TTL level) Communication Protocol

The measurement result is outputted by UART (TTL level), the unit is cm. Every 10bit is a data frame, of which the format is as follows:

bit 1	bit 2	bit 3	bit 4	bit 5	bit 6	bit 7	bit 8	bit 9	bit 10
start bit	data bit								stop bit

Baud rate: 9600 bps

## Data Format

1. Send character “n” in character mode, 1 byte.
2. Send character “1” in character mode, 1 byte.
3. Send decimal character “.” in character mode, 1 byte.
4. Send character “v” in character mode, 1 byte.
5. Send character “a” in character mode, 1 byte.
6. Send character “1” in character mode, 1 byte.
7. Send character “=” in character mode, 1 byte.
8. Send the hundreds digit of the measurement result in character mode, 1 byte.
9. Send the tens digit of the measurement result in character mode, 1 byte.
10. Send the single digit of the measurement result in character mode, 1 byte.
11. Send the terminator “0xff”.

Example: n1.val=125 means the distance between the module and the object is 125cm

## Revision History:

Version	Date (MM/DD/YY)	DWN	Statement
A2.0	12/05/2017		Updated dimensions
A3.0	6/7/2018		Added wiring diagram

### TENTATIVE RELEASE:

This specification is based on design objectives and is strictly Preliminary and subject to change. Test data may exist, but this specification is subject to change based on the results of additional testing and evaluation. Application specific specifications will be produced for approval prior to production product being released.

<b>Part No.</b> UM0090-000	<b>Rev</b> A3	<b>Title</b> Ultrasonic Distance Measurement Module	<b>Sheet No.</b> 5 of 5
-------------------------------	------------------	--	----------------------------