



**GARDTEC**

Part Number:

## HP75-72R ("45" Plug)

Wire: **SPT1 2 conductor with Red Wire 105°C, 300 volts**

Lengths: **72" (1829mm)**

Other options:

- **terminal connections** (any)
- **heat shrink**
- **labeling**
- **stripping**
- **tinning**
- **three conductor cords**
- **complete wire harness assemblies**  
(rated at 105°C, 300 volts)
- **red tracer cords**  
(all head configurations and lengths)

Listings:



UL listed (E189621, E156798)  
Rated 10 AMP/125 VAC

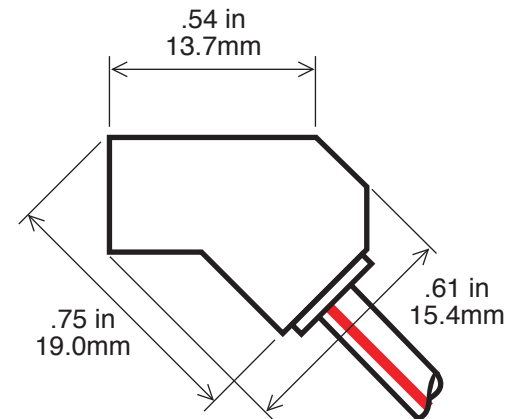
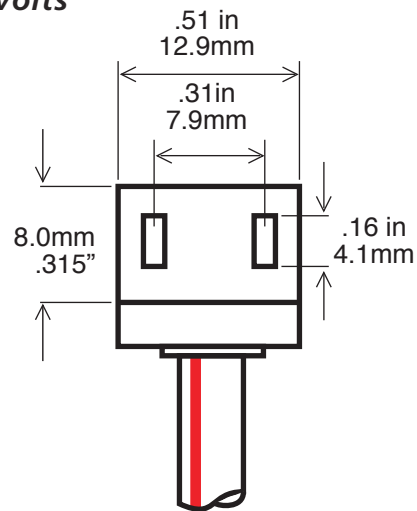

Red wire on right side of fan cord.