

Contents	Page
Han® 200 A module.....	06.7
Han® 100 A module.....	06.10
Han® 100 A Single module.....	06.12
Han® 70 A module.....	06.14
Han® 70 A Hybrid module	06.17
Han® 40 A module.....	06.19
Han® C module	06.21
Han® CC Protected module	06.23
Han® CD module	06.25
Han E® module	06.28
Han® E Screw module	06.31
Han E® Protected module.....	06.33
Han® EE module.....	06.36
Han® EEE module	06.39
Han® ES module.....	06.41
Han® HV module.....	06.43
Han® HV Single module.....	06.46
Han DD® module	06.48
Han® DDD module.....	06.51
Han® High Density module	06.53
Han® D-Sub module	06.55
Han® USB module	06.58
Han® FireWire module	06.60

Contents	Page
Han® RJ45 module, female	06.61
Han® RJ45 module, male	06.62
RJ45 patch cable.....	06.66
Han® GigaBit module.....	06.68
Han® Shielded module.....	06.70
Han® MegaBit module	06.72
Accessories for GigaBit, Shielded and MegaBit.....	06.75
Han-Quintax® module	06.77
Han-Quintax® High Density module.....	06.79
Han® D Coax	06.81
Han® E Coax.....	06.83
Han® Multi module	06.85
Han® Pneumatic module.....	06.89
Han® SC module.....	06.92
Han® LC module	06.94
Han-Modular® Hinged frames.....	06.96
Han-Modular® Docking frames	06.101
Han-Modular® Compact.....	06.105
Han-Modular® Twin	06.109
Han-Modular® ECO	06.112
Accessories	06.117

Description of the Han-Modular® system

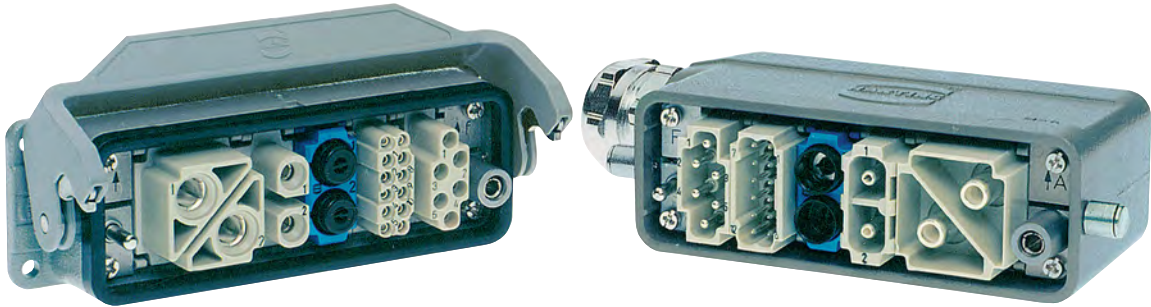

The Han-Modular® series is designed for combining different transmission media in one connector. The multifaceted system of inserts, contacts, frames, hoods and housings fulfils individual customer requirements. To continuously enable new configurations, the Han-Modular® series grows constantly.

More than 50 different modules for different transmission media are available. These cover various termination techniques. The patented Han-Modular® hinged frame enables the configuration of all modules in the well-accepted Han® hoods and housings size 6B-48B. Further additional solutions are available, e.g. suitable docking frames for drawer units.

Individual customer requirements can be realized. Combining various transmission media in one single connector results in lower expenditures in installation time and production downtime. Space savings and cost savings are further benefits. The easy extension possibilities secure a future safe design.

Product features at a glance

- Flexible solutions according to specific customer requirements
- Reduction of installation time and production downtimes
- Space savings
- Cost savings
- Future safe design, easy extension

















Assembly details



Series	Han® 200 A Axial module	Han® 200 A Crimp module	Han® 100 A Axial module	Han® 100 A Crimp module
Number of contacts	1	1	2	2
Modules	Axial screw terminal 	Crimp terminal 	Axial screw terminal 	Crimp terminal 
Rated current	200 A	200 A	100 A	100 A
Rated voltage	1000 V	1000 V	1000 V	1000 V
Wire gauge	25 ... 70 mm ²	25 ... 70 mm ²	10 ... 38 mm ²	10 ... 35 mm ²
Series	Han® 100 A Single module	Han® 70 A Axial module	Han® 70 A Crimp module	Han® 70 A Hybrid module
Number of contacts	1	2	2	1 / 4
Modules	Axial screw terminal 	Axial screw terminal 	Crimp terminal 	Axial screw terminal 
Rated current	100 A	70 A	70 A	70 A / 16 A
Rated voltage	830 V	1000 V	1000 V	1000 V / 400 V
Wire gauge	10 ... 35 mm ²	6 ... 22 mm ²	10 ... 25 mm ²	6 ... 22 mm ² / 0.14 ... 4 mm ²
Series	Han® 40 A Axial module	Han® 40 A Crimp module	Han® C Axial module	Han® C module
Number of contacts	2	2	3	3
Modules	Axial screw terminal 	Crimp terminal 	Axial screw terminal 	Crimp terminal 
Rated current	40 A	40 A	40 A	40 A
Rated voltage	1000 V	1000 V	690 V	690 V
Wire gauge	2.5 ... 10 mm ²	1.5 ... 10 mm ²	2.5 ... 10 mm ²	1.5 ... 10 mm ²
Series	Han® CC Protected module	Han® CD module	Han® E Quick Lock module	Han E® module
Number of contacts	4	3 / 4	6	6
Modules	Crimp terminal 	Crimp terminal 	Quick Lock terminal 	Crimp terminal 
Rated current	40 A	40 A / 10 A	16 A	16 A
Rated voltage	830 V	830 V / 830 V	500 V	500 V
Wire gauge	1.5 ... 6 mm ²	1.5 ... 6 mm ² / 0.14 ... 2.5 mm ²	0.5 ... 2.5 mm ²	0.14 ... 4 mm ²

Summary



Series	Han E® Screw module	Han E® Protected module	Han® EE Quick Lock module	Han® EE module
Number of contacts	5	6	8	8
Modules	Screw terminal 	Crimp terminal 	Quick Lock terminal 	Crimp terminal 
Rated current	16 A	16 A	16 A	16 A
Rated voltage	230 / 400 V	830 V	400 V	400 V
Wire gauge	0.5 ... 2.5 mm ²	0.14 ... 4 mm ²	0.5 ... 2.5 mm ²	0.14 ... 4 mm ²
Series	Han® EEE module	Han® ES module	Han® HV Single module	Han® HV module
Number of contacts	20	5	2	2
Modules	Crimp terminal 	Cage-clamp terminal 	Crimp terminal 	Crimp terminal 
Rated current	16 A	16 A	16 A	16 A
Rated voltage	500 V	400 V	2500 V	2900 / 5000 V
Wire gauge	0.14 ... 4 mm ²	0.14 ... 2.5 mm ²	0.5 ... 4 mm ²	0.5 ... 4 mm ²
Series	Han® HV module	Han DD® Quick Lock module	Han DD® module	Han® DDD module
Number of contacts	2	12	12	17
Modules	Crimp terminal 	Quick Lock terminal 	Crimp terminal 	Crimp terminal 
Rated current	40 A	10 A	10 A	10 A
Rated voltage	2900 / 5000 V	250 V	250 V	160 V
Wire gauge	1.5 ... 10 mm ²	0.25 ... 1.5 mm ²	0.14 ... 2.5 mm ²	0.14 ... 2.5 mm ²
Series	Han® High Density module	Han® D-Sub module	Han® USB module	Han® FireWire module
Number of contacts	25	9	4	6
Modules	Crimp terminal 	Crimp terminal 	USB 2.0 	IEEE 1394 
Rated current	4 A	5 A		
Rated voltage	50 V	50 V		
Wire gauge	0.08 ... 0.52 mm ²	0.08 ... 0.52 mm ²		

Han-Modular

Summary



Series	Han® RJ45 module	Han® GigaBit module	Han® MegaBit module	Han® Shielded module
Number of contacts	8	8	2 x 4	20
Modules	Ethernet Cat. 6	Ethernet Cat. 6A	Ethernet Cat. 5e	Crimp terminal

Han-Modular

Series	Han-Quintax® module			
Number of contacts	2			
Modules				
Contacts	<p>Han-Quintax® contact 4 + shielding</p>	<p>High Density Quintax contact 8 + shielding</p>	<p>Han D® Coax contact 1 + shielding 75 Ω</p>	<p>Han E® Coax contact 1 + shielding 50 Ω</p>

Series	Han® Multi module			
Number of contacts	4		12	
Modules				
Contacts	<p>FOC contacts</p> <p>Multimode F.O. HCS®* / PCF F.O. 1 mm POF</p>	<p>Coaxial contacts</p> <p>50 Ω RG 174 75 Ω RG 179 50 Ω RG 58</p>	<p>FOC contacts</p> <p>Multimode F.O. HCS®* / PCF F.O. 1 mm POF</p>	<p>Coaxial contacts</p> <p>50 Ω RG 174 75 Ω RG 179</p>

Series	Han® Pneumatic module		Han® SC module	Han® LC module	
Number of contacts	2	3	4	6	
Modules					
Contacts	<p>Ø 6.0 mm</p>	<p>Ø 1.6 mm Ø 3.0 mm Ø 4.0 mm</p>	<p>SC contact for GI 50; 62.5 / 125 μm</p>	<p>LC Contact for LWL Multi Mode LC Contact for LWL Single Mode</p>	

* HCS® = Hard Clad Silica (is registered trade mark of the SpecTran Corporation)

Features

- Crimp- and Axial module are compatible modules
- Contacts can be unlocked from the mating side
- Power module for big wire cross sections up to 70mm²
- Suitable as a 3 + PE connector in a Han® 32 B housing

Derating

Current carrying capacity

The current carrying capacity of the connectors is limited by the thermal load capability of the contact element material including the connections and the insulating parts. The derating curve is therefore valid for currents which flow constantly (non-intermittent) through each contact element of the connector evenly, without exceeding the allowed maximum temperature.

Measuring and testing techniques acc. to IEC 60512-5-2

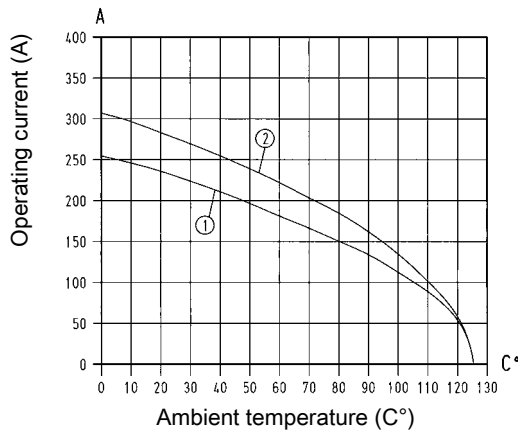

- ① 24 B hoods/housings with 3 modules Wire cross section 50 mm²
 ② 24 B hoods/housings with 3 modules Wire cross section 70 mm²

Technical characteristics

Contacts	1
Electrical data acc. to IEC 61984	200 A 1000 V 8 kV 3
Rated current	200 A
Rated voltage	1000 V
Rated impulse voltage	8 kV
Pollution degree	3
Rated voltage acc. to UL	600 V
Insulation resistance	≥10 ¹⁰ Ohm
Limiting temperatures	-40 °C ... 125 °C
Flammability (insert) acc. to UL 94	V 0
Mating cycles	≥500
Material (insert)	polycarbonate
Colour (insert)	RAL 7032 (light grey)
Material (contact)	copper alloy
Hex key	SW 5

Specifications and approvals

EN 50124-1
 IEC 60664-1
 IEC 61984



Details

Crimping tools see chapter 90

Remarks on the crimp technique



The wire gauges mentioned in the catalogue refer to geometric wire gauges of cables.



Number of contacts

1

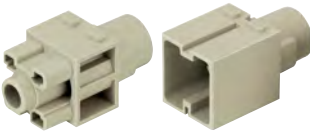
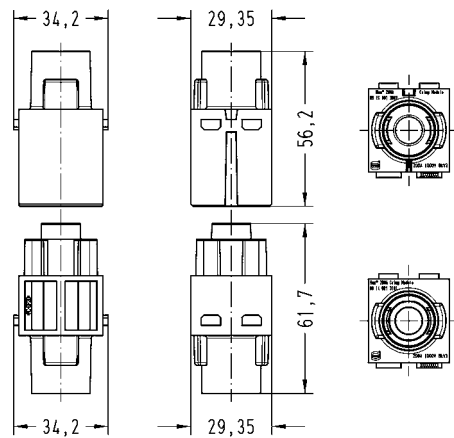
1000 V
200 A

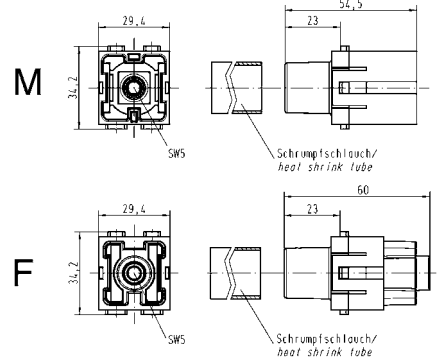
Han-
Modular

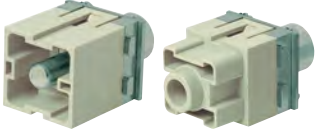
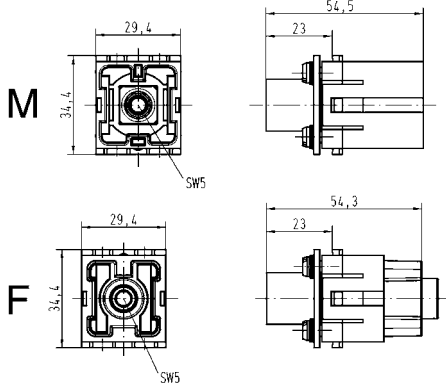
Identification	Wire cross section (mm ²)	Part number		Drawing Dimensions in mm
		male	female	
<p>Han-Modular®, Han® 200 A Crimp module, Crimp terminal</p>  <p>Please order crimp contacts separately.</p>		09 14 001 3001	09 14 001 3101	 <p>Removal tool 09 99 000 0820 see chapter 90</p>
<p>Han-Modular®, Han® 200 A Axial module, Axial screw terminal, silver plated contacts, contact resistance ca.0.2 mOhm</p> 	25 – 40 40 – 70	09 14 001 2663 09 14 001 2662	09 14 001 2763 09 14 001 2762	 <p>Hex key with grip 09 99 000 0364 adapter 3/8" 09 99 000 0371 see chapter 90 Stripping length 16 mm</p>

Identification	Wire cross section (mm ²)	Part number		Drawing Dimensions in mm															
		male	female																
Han-Modular®, Han® 200 A PE module, Axial screw terminal, silver plated contacts, contact resistance ca.0.2 mOhm 	25 – 40 40 – 70	09 14 001 2668 09 14 001 2667	09 14 001 2768 09 14 001 2767	 <p> Hex key with grip 09 99 000 0364 adapter 3/8" 09 99 000 0371 see chapter 90 Stripping length 16 mm </p>															
Crimp contact, TC 200, silver plated contacts, ... 14 mm contact resistance ≤0.3 mOhm 	25 35 50 70	09 11 000 6120 09 11 000 6121 09 11 000 6122 09 11 000 6123	09 11 000 6220 09 11 000 6221 09 11 000 6222 09 11 000 6223	<table border="1"> <thead> <tr> <th>Wire gauge</th> <th>∅</th> <th>Stripping length A</th> </tr> </thead> <tbody> <tr> <td>25 mm²</td> <td>7</td> <td>19 mm</td> </tr> <tr> <td>35 mm²</td> <td>8.2</td> <td>20 mm</td> </tr> <tr> <td>50 mm²</td> <td>10</td> <td>22.5 mm</td> </tr> <tr> <td>70 mm²</td> <td>11.5</td> <td>22.5 mm</td> </tr> </tbody> </table> <p>for stranded wire according to IEC 60 228 Class 5</p>	Wire gauge	∅	Stripping length A	25 mm ²	7	19 mm	35 mm ²	8.2	20 mm	50 mm ²	10	22.5 mm	70 mm ²	11.5	22.5 mm
Wire gauge	∅	Stripping length A																	
25 mm ²	7	19 mm																	
35 mm ²	8.2	20 mm																	
50 mm ²	10	22.5 mm																	
70 mm ²	11.5	22.5 mm																	

Features

- Crimp- and Axial module are compatible modules
- Contacts can be unlocked from the mating side

Derating

Current carrying capacity

The current carrying capacity of the connectors is limited by the thermal load capability of the contact element material including the connections and the insulating parts. The derating curve is therefore valid for currents which flow constantly (non-intermittent) through each contact element of the connector evenly, without exceeding the allowed maximum temperature.

Measuring and testing techniques acc. to IEC 60512-5-2

Crimp terminal

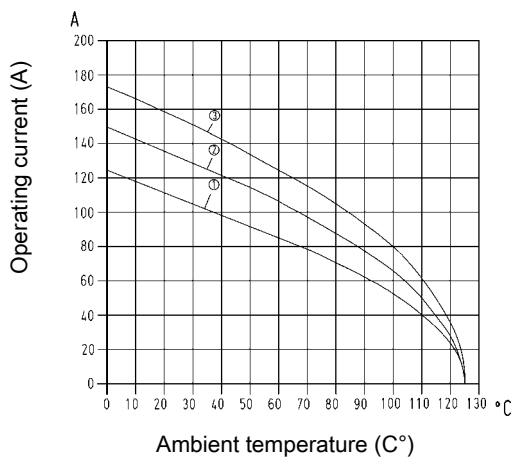

- ① 24 B hoods/housings with 3 modules Wire cross section 16 mm²
- ② 24 B hoods/housings with 3 modules Wire cross section 25 mm²
- ③ 24 B hoods/housings with 3 modules Wire cross section 35 mm²

Derating

Axial screw termination

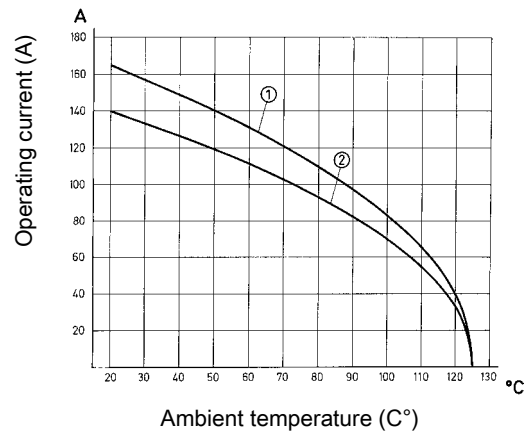

- ① 24 B hoods/housings with 3 modules Wire cross section 35 mm²
- ② 24 B hoods/housings with 3 modules Wire cross section 25 mm²

Technical characteristics

Contacts	2
Electrical data acc. to IEC 61984	100 A 1000 V 8 kV 3
Rated current	100 A
Rated voltage	1000 V
Rated impulse voltage	8 kV
Pollution degree	3
Rated voltage acc. to UL	600 V
Insulation resistance	≥10 ¹⁰ Ohm
Limiting temperatures	-40 °C ... 125 °C
Flammability (insert) acc. to UL 94	V 0
Mating cycles	≥500
Material (insert)	polycarbonate
Colour (insert)	RAL 7032 (light grey)
Material (contact)	copper alloy
Hex key	SW 4

Specifications and approvals

IEC 60664-1
IEC 61984



Details

Crimping tools see chapter 90





Remarks on the crimp technique

The wire gauges mentioned in the catalogue refer to geometric wire gauges of cables.

Number of contacts

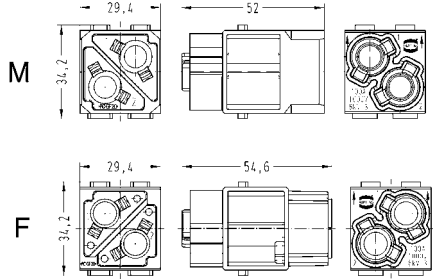
2

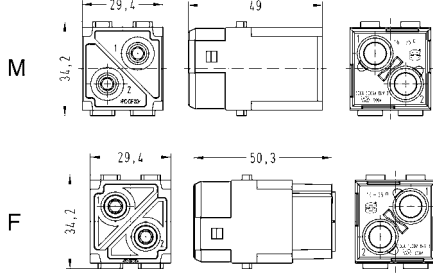
1000 V
100 A

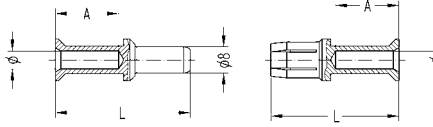
Identification	Wire cross section (mm ²)	Part number		Drawing Dimensions in mm															
		male	female																
Han-Modular®, Han® 100 A Crimp module, Crimp terminal, silver plated contacts  Please order crimp contacts separately.		09 14 002 3051	09 14 002 3151																
Han-Modular®, Han® 200 A Crimp module, Axial screw terminal, silver plated contacts, contact resistance ≤0.3 mOhm 	10 – 25 16 – 35 38	09 14 002 2653 09 14 002 2651 09 14 002 2650	09 14 002 2753 09 14 002 2751 09 14 002 2750																
Crimp contact, TC 100, silver plated contacts, contact resistance ≤0.3 mOhm 	10 16 25 35	09 11 000 6114 09 11 000 6116 09 11 000 6125 09 11 000 6135	09 11 000 6214 09 11 000 6216 09 11 000 6225 09 11 000 6235	 <table border="1"> <thead> <tr> <th>Wire gauge</th> <th>Ø</th> <th>Stripping length A</th> </tr> </thead> <tbody> <tr> <td>10 mm²</td> <td>4.3</td> <td>19 mm</td> </tr> <tr> <td>16 mm²</td> <td>5.5</td> <td>19 mm</td> </tr> <tr> <td>25 mm²</td> <td>7</td> <td>19 mm</td> </tr> <tr> <td>35 mm²</td> <td>8.2</td> <td>16 mm</td> </tr> </tbody> </table> for stranded wire according to IEC 60 228 Class 5	Wire gauge	Ø	Stripping length A	10 mm ²	4.3	19 mm	16 mm ²	5.5	19 mm	25 mm ²	7	19 mm	35 mm ²	8.2	16 mm
Wire gauge	Ø	Stripping length A																	
10 mm ²	4.3	19 mm																	
16 mm ²	5.5	19 mm																	
25 mm ²	7	19 mm																	
35 mm ²	8.2	16 mm																	

Han-Modular

Features

- Crimp or axial screw termination available
- Unlock of contacts with a screw driver from mating side
- Connect PE contact with special cable shoe
- Separate axial screw contacts can be terminated without any special tools directly to the wire

Technical characteristics

Contacts	1
Electrical data acc. to IEC 61984	100 A 830 V 8 kV 3
Rated current	100 A
Rated voltage	830 V
Rated impulse voltage	8 kV
Pollution degree	3
Rated voltage acc. to UL	600 V
Insulation resistance	≥10 ¹⁰ Ohm
Limiting temperatures	-40 °C ... 125 °C
Flammability (insert) acc. to UL 94	V 0
Mating cycles	≥500
Material (insert)	polycarbonate
Colour (insert)	RAL 7032 (light grey)
Material (contact)	copper alloy
Hex key	SW 4

Specifications and approvals

IEC 60664-1
IEC 61984



Details

Crimping tools see chapter 90

Remarks on the axial screw technique

The wire gauges mentioned in the catalogue refer to geometric wire gauges of cables.





Remarks on the crimp technique

The wire gauges mentioned in the catalogue refer to geometric wire gauges of cables.

Number of contacts

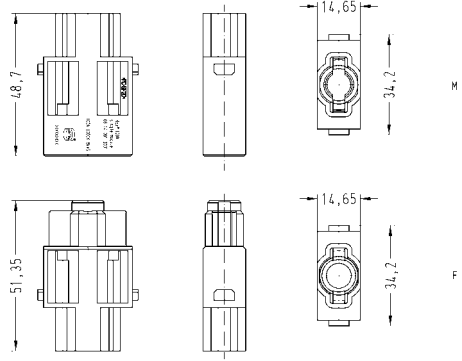
1

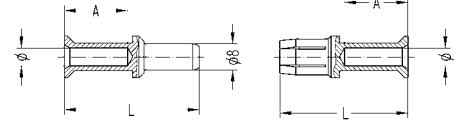
830 V
100 A

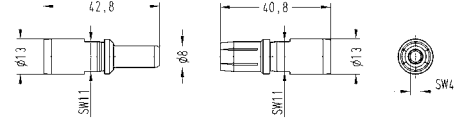
Identification	Wire cross section (mm ²)	Part number		Drawing Dimensions in mm															
		male	female																
Han-Modular®, Han® 100 A Single module, contact resistance ≤0.3 mOhm  Please order contacts separately.		09 14 001 3031	09 14 001 3131																
Crimp contact, TC 100, silver plated contacts, contact resistance ≤0.3 mOhm 	10 16 25 35	09 11 000 6114 09 11 000 6116 09 11 000 6125 09 11 000 6135	09 11 000 6214 09 11 000 6216 09 11 000 6225 09 11 000 6235	 <table border="1" data-bbox="1034 1232 1497 1415"> <thead> <tr> <th>Wire gauge</th> <th>Ø</th> <th>Stripping length A</th> </tr> </thead> <tbody> <tr> <td>10 mm²</td> <td>4.3</td> <td>19 mm</td> </tr> <tr> <td>16 mm²</td> <td>5.5</td> <td>19 mm</td> </tr> <tr> <td>25 mm²</td> <td>7</td> <td>19 mm</td> </tr> <tr> <td>35 mm²</td> <td>8.2</td> <td>16 mm</td> </tr> </tbody> </table> for stranded wire according to IEC 60 228 Class 5	Wire gauge	Ø	Stripping length A	10 mm ²	4.3	19 mm	16 mm ²	5.5	19 mm	25 mm ²	7	19 mm	35 mm ²	8.2	16 mm
Wire gauge	Ø	Stripping length A																	
10 mm ²	4.3	19 mm																	
16 mm ²	5.5	19 mm																	
25 mm ²	7	19 mm																	
35 mm ²	8.2	16 mm																	
Axial screw contact, silver plated contacts, contact resistance ≤0.3 mOhm 	10–25 16–35	09 11 000 6112 09 11 000 6113	09 11 000 6212 09 11 000 6213	 Stripping length 13 mm Tightening torque <table border="1" data-bbox="1193 1666 1497 1729"> <thead> <tr> <th>mm²</th> <th>10</th> <th>16</th> <th>25</th> <th>35</th> </tr> </thead> <tbody> <tr> <td>Nm</td> <td>6</td> <td>6</td> <td>7</td> <td>8</td> </tr> </tbody> </table>	mm ²	10	16	25	35	Nm	6	6	7	8					
mm ²	10	16	25	35															
Nm	6	6	7	8															

Han-Modular

Features

- For power circuits
- Male inserts with protection collar
- Polarisation of module

Derating

Current carrying capacity

The current carrying capacity of the connectors is limited by the thermal load capability of the contact element material including the connections and the insulating parts. The derating curve is therefore valid for currents which flow constantly (non-intermittent) through each contact element of the connector evenly, without exceeding the allowed maximum temperature.

Measuring and testing techniques acc. to IEC 60512-5-2

Crimp terminal

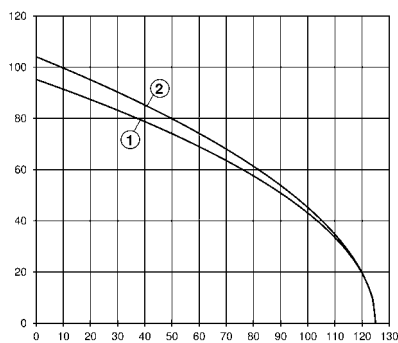

- ① 24 B hoods/housings with 6 modules Wire cross section 16 mm²
- ② 24 B hoods/housings with 6 modules Wire cross section 25 mm²

Derating

Axial screw termination

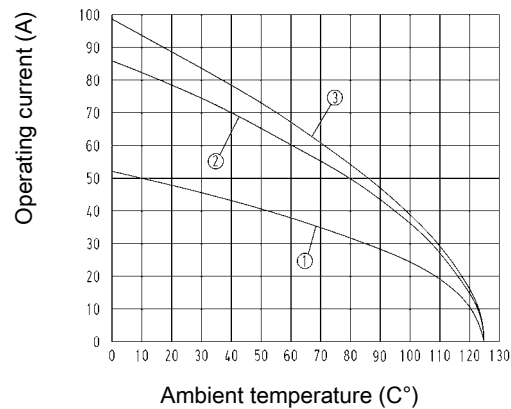

- ① 24 B hoods/housings with 6 modules Wire cross section 6 mm²
- ② 24 B hoods/housings with 6 modules Wire cross section 16 mm²
- ③ 24 B hoods/housings with 6 modules Wire cross section 22 mm²

Technical characteristics

Contacts	2
Electrical data acc. to IEC 61984	70 A 1000 V 8 kV 3
Rated current	70 A
Rated voltage	1000 V
Rated impulse voltage	8 kV
Pollution degree	3
Rated voltage acc. to UL	600 V
Insulation resistance	≥10 ¹⁰ Ohm
Limiting temperatures	-40 °C ... 125 °C
Flammability (insert) acc. to UL 94	V 0
Mating cycles	≥500
Material (insert)	polycarbonate
Colour (insert)	RAL 7032 (light grey)
Material (contact)	copper alloy
Hex key	SW 2.5

Specifications and approvals

IEC 60664-1
IEC 61984



Details

Crimping tools see chapter 90



Remarks on the crimp technique

The wire gauges mentioned in the catalogue refer to geometric wire gauges of cables.

Number of contacts

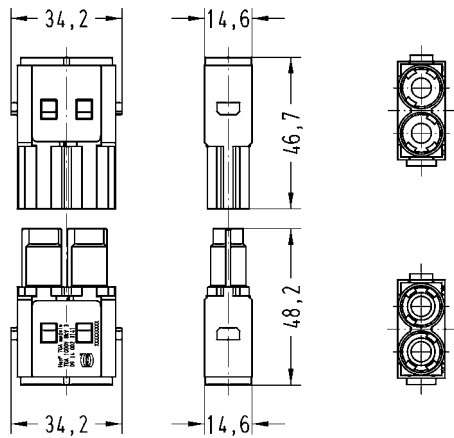

2

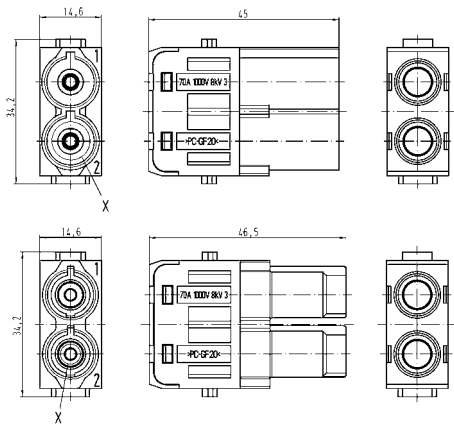
1000 V
70 A

Identification	Wire cross section (mm²)	Part number		Drawing Dimensions in mm
		male	female	
<p>Han-Modular®, Han® 70 A Crimp module, Crimp terminal</p> 		09 14 002 3041	09 14 002 3141	
<p>Han-Modular®, Han® 70 A Axial module, Axial screw terminal, silver plated contacts, contact resistance ≤0.5 mOhm</p>  <p>finger safe</p>	6 – 16 14 – 22	09 14 002 2641 09 14 002 2642		

Han-Modular

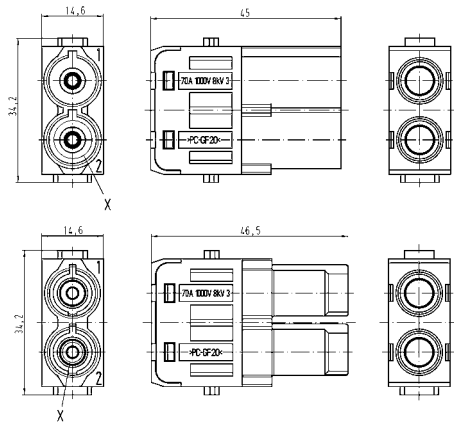
Han-Modular

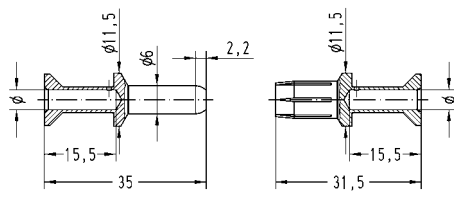
Identification	Wire cross section (mm ²)	Part number		Drawing Dimensions in mm												
		male	female													
Han-Modular®, Han® 70 A Axial module, Axial screw terminal, silver plated contacts, contact resistance ≤0.5 mOhm 	6 – 16 14 – 22	09 14 002 2646 09 14 002 2647	09 14 002 2741 09 14 002 2742													
Crimp contact, TC 70, silver plated contacts, contact resistance ≤0.5 mOhm 	10 16 25	09 11 000 6131 09 11 000 6132 09 11 000 6133	09 11 000 6231 09 11 000 6232 09 11 000 6233	 <table border="1"> <thead> <tr> <th>Wire gauge</th> <th>Ø</th> <th>Stripping length A</th> </tr> </thead> <tbody> <tr> <td>10 mm²</td> <td>4.3</td> <td>15.5 mm</td> </tr> <tr> <td>16 mm²</td> <td>5.5</td> <td>15.5 mm</td> </tr> <tr> <td>25 mm²</td> <td>7</td> <td>15.5 mm</td> </tr> </tbody> </table> <p>for stranded wire according to IEC 60 228 Class 5</p>	Wire gauge	Ø	Stripping length A	10 mm ²	4.3	15.5 mm	16 mm ²	5.5	15.5 mm	25 mm ²	7	15.5 mm
Wire gauge	Ø	Stripping length A														
10 mm ²	4.3	15.5 mm														
16 mm ²	5.5	15.5 mm														
25 mm ²	7	15.5 mm														

Features

- Axial screw termination
- For power circuits
- Male inserts with protection collar
- Polarisation of module

Technical characteristics

Contacts	1/4
Electrical data acc. to IEC 61984	70 A 1000 V 8 kV 3
Rated current	70 A
Rated voltage	1000 V
Rated impulse voltage	8 kV
Pollution degree	3
Electrical data, signal	16 A 400 V 6 kV 3
Rated current	16 A
Rated voltage	400 V
Rated impulse voltage	6 kV
Insulation resistance	≥10 ¹⁰ Ohm
Limiting temperatures	-40 °C ... 125 °C
Flammability (insert) acc. to UL 94	V 0
Mating cycles	≥500
Material (insert)	polycarbonate
Colour (insert)	RAL 7032 (light grey)
Material (contact)	copper alloy
Hex key	SW 2.5

Specifications and approvals

IEC 60664-1
IEC 61984



Details

Crimping tools see chapter 90

Remarks on the axial screw technique

The wire gauges mentioned in the catalogue refer to geometric wire gauges of cables.

Remarks on the crimp technique



The wire gauges mentioned in the catalogue refer to geometric wire gauges of cables.

Number of contacts

1/4

1000 V / 400 V
70 A/16 A

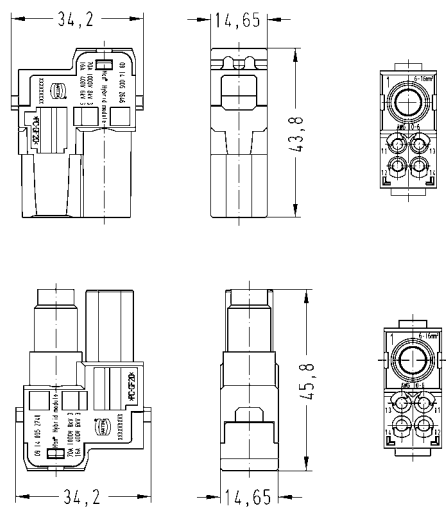
Han-Modular

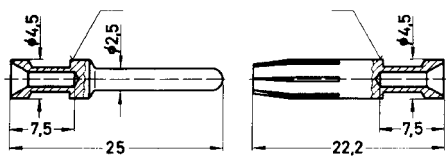
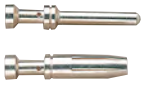
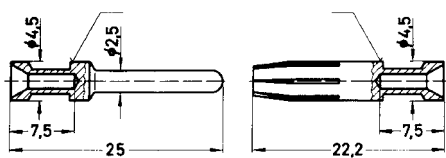
Identification	Wire cross section (mm ²)	Part number		Drawing Dimensions in mm																											
		male	female																												
Han-Modular®, Han-Modular® 70 A Hybrid module, Axial screw terminal  Please order signal contacts separately.	6 – 16 14 – 22	09 14 005 2646 09 14 005 2647	09 14 005 2741 09 14 005 2742																												
Han E®, Crimp contact, gold plated contacts, contact resistance ≤1 mOhm 	0.14 – 0.37 0.5 0.75 1 1.5 2.5 4	09 33 000 6117 09 33 000 6122 09 33 000 6115 09 33 000 6118 09 33 000 6116 09 33 000 6123 09 33 000 6119	09 33 000 6217 09 33 000 6222 09 33 000 6215 09 33 000 6218 09 33 000 6216 09 33 000 6223 09 33 000 6221	 <table border="1"> <thead> <tr> <th>Identification</th> <th>Wire gauge</th> <th>Stripping length</th> </tr> </thead> <tbody> <tr> <td>no groove</td> <td>0.14-0.37 mm² AWG 26-22</td> <td>7.5 mm</td> </tr> <tr> <td>no groove</td> <td>0.5 mm² AWG 20</td> <td>7.5 mm</td> </tr> <tr> <td>1 groove*</td> <td>0.75 mm² AWG 18</td> <td>7.5 mm</td> </tr> <tr> <td>1 groove</td> <td>1 mm² AWG 18</td> <td>7.5 mm</td> </tr> <tr> <td>2 grooves</td> <td>1.5 mm² AWG 16</td> <td>7.5 mm</td> </tr> <tr> <td>3 grooves</td> <td>2.5 mm² AWG 14</td> <td>7.5 mm</td> </tr> <tr> <td>wide groove</td> <td>3 mm² AWG 12</td> <td>7.5 mm</td> </tr> <tr> <td>no groove</td> <td>4 mm² AWG 12</td> <td>7.5 mm</td> </tr> </tbody> </table> <p>* on the back crimp collar</p>	Identification	Wire gauge	Stripping length	no groove	0.14-0.37 mm ² AWG 26-22	7.5 mm	no groove	0.5 mm ² AWG 20	7.5 mm	1 groove*	0.75 mm ² AWG 18	7.5 mm	1 groove	1 mm ² AWG 18	7.5 mm	2 grooves	1.5 mm ² AWG 16	7.5 mm	3 grooves	2.5 mm ² AWG 14	7.5 mm	wide groove	3 mm ² AWG 12	7.5 mm	no groove	4 mm ² AWG 12	7.5 mm
Identification	Wire gauge	Stripping length																													
no groove	0.14-0.37 mm ² AWG 26-22	7.5 mm																													
no groove	0.5 mm ² AWG 20	7.5 mm																													
1 groove*	0.75 mm ² AWG 18	7.5 mm																													
1 groove	1 mm ² AWG 18	7.5 mm																													
2 grooves	1.5 mm ² AWG 16	7.5 mm																													
3 grooves	2.5 mm ² AWG 14	7.5 mm																													
wide groove	3 mm ² AWG 12	7.5 mm																													
no groove	4 mm ² AWG 12	7.5 mm																													
Han E®, Crimp contact, silver plated contacts, contact resistance ≤1 mOhm 	0.14 – 0.37 0.5 0.75 1 1.5 2.5 3 4	09 33 000 6127 09 33 000 6121 09 33 000 6114 09 33 000 6105 09 33 000 6104 09 33 000 6102 09 33 000 6106 09 33 000 6107	09 33 000 6227 09 33 000 6220 09 33 000 6214 09 33 000 6205 09 33 000 6204 09 33 000 6202 09 33 000 6206 09 33 000 6207	 <table border="1"> <thead> <tr> <th>Identification</th> <th>Wire gauge</th> <th>Stripping length</th> </tr> </thead> <tbody> <tr> <td>no groove</td> <td>0.14-0.37 mm² AWG 26-22</td> <td>7.5 mm</td> </tr> <tr> <td>no groove</td> <td>0.5 mm² AWG 20</td> <td>7.5 mm</td> </tr> <tr> <td>1 groove*</td> <td>0.75 mm² AWG 18</td> <td>7.5 mm</td> </tr> <tr> <td>1 groove</td> <td>1 mm² AWG 18</td> <td>7.5 mm</td> </tr> <tr> <td>2 grooves</td> <td>1.5 mm² AWG 16</td> <td>7.5 mm</td> </tr> <tr> <td>3 grooves</td> <td>2.5 mm² AWG 14</td> <td>7.5 mm</td> </tr> <tr> <td>wide groove</td> <td>3 mm² AWG 12</td> <td>7.5 mm</td> </tr> <tr> <td>no groove</td> <td>4 mm² AWG 12</td> <td>7.5 mm</td> </tr> </tbody> </table> <p>* on the back crimp collar</p>	Identification	Wire gauge	Stripping length	no groove	0.14-0.37 mm ² AWG 26-22	7.5 mm	no groove	0.5 mm ² AWG 20	7.5 mm	1 groove*	0.75 mm ² AWG 18	7.5 mm	1 groove	1 mm ² AWG 18	7.5 mm	2 grooves	1.5 mm ² AWG 16	7.5 mm	3 grooves	2.5 mm ² AWG 14	7.5 mm	wide groove	3 mm ² AWG 12	7.5 mm	no groove	4 mm ² AWG 12	7.5 mm
Identification	Wire gauge	Stripping length																													
no groove	0.14-0.37 mm ² AWG 26-22	7.5 mm																													
no groove	0.5 mm ² AWG 20	7.5 mm																													
1 groove*	0.75 mm ² AWG 18	7.5 mm																													
1 groove	1 mm ² AWG 18	7.5 mm																													
2 grooves	1.5 mm ² AWG 16	7.5 mm																													
3 grooves	2.5 mm ² AWG 14	7.5 mm																													
wide groove	3 mm ² AWG 12	7.5 mm																													
no groove	4 mm ² AWG 12	7.5 mm																													

Features

- Crimp or axial screw termination available
- No special tools required for axial-screw termination

Derating

Current carrying capacity

The current carrying capacity of the connectors is limited by the thermal load capability of the contact element material including the connections and the insulating parts. The derating curve is therefore valid for currents which flow constantly (non-intermittent) through each contact element of the connector evenly, without exceeding the allowed maximum temperature.

Measuring and testing techniques acc. to IEC 60512-5-2

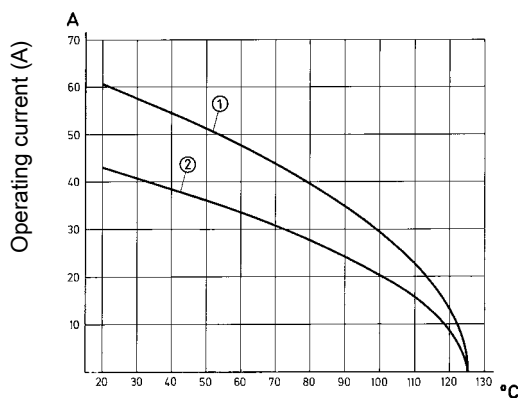

Ambient temperature (C°)

- ① 24 B hoods/housings with 6 modules Wire cross section 10 mm²
- ② 24 B hoods/housings with 6 modules Wire cross section 6 mm²

Technical characteristics

Contacts	2
Electrical data acc. to IEC 61984	40 A 1000 V 8 kV 3
Rated current	40 A
Rated voltage	1000 V
Rated impulse voltage	8 kV
Pollution degree	3
Rated voltage acc. to UL	600 V
Insulation resistance	≥10 ¹⁰ Ohm
Limiting temperatures	-40 °C ... 125 °C
Flammability (insert) acc. to UL 94	V 0
Mating cycles	≥500
Material (insert)	polycarbonate
Colour (insert)	RAL 7032 (light grey)
Material (contact)	copper alloy
Hex key	SW 2

Specifications and approvals

IEC 60664-1
IEC 61984



Details

Crimping tools see chapter 90

Remarks on the crimp technique





The wire gauges mentioned in the catalogue refer to geometric wire gauges of cables.

Number of contacts

2

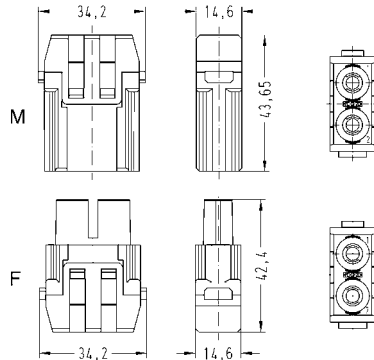
1000 V
40 A

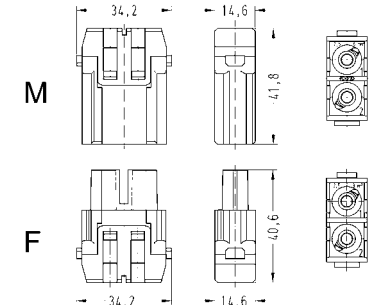
Han-Modular

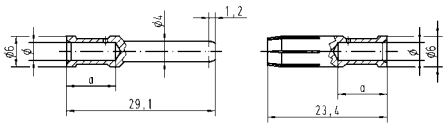
Identification	Wire cross section (mm ²)	Part number		Drawing Dimensions in mm																				
		male	female																					
Han-Modular®, Han® 40 A Crimp module, Crimp terminal  Please order crimp contacts separately.		09 14 002 3002	09 14 002 3102	 Contact arrangement (view from termination side)																				
Han-Modular®, Han® 40 A Axial module, Axial screw terminal, silver plated contacts, contact resistance ≤0.3 mOhm 	2.5–8 6–10	09 14 002 2601 09 14 002 2602	09 14 002 2701 09 14 002 2702	 Contact arrangement (view from termination side) Stripping length <table border="1" data-bbox="1157 1534 1460 1585"> <tr> <td>mm²</td> <td>2,5</td> <td>4</td> <td>6</td> <td>10</td> </tr> <tr> <td>mm</td> <td>5⁺¹</td> <td>5⁺¹</td> <td>8⁺¹</td> <td>11⁺¹</td> </tr> </table> Tightening torque <table border="1" data-bbox="1157 1601 1460 1668"> <tr> <td>mm²</td> <td>2,5</td> <td>4</td> <td>6</td> <td>10</td> </tr> <tr> <td>Nm</td> <td>1,5</td> <td>1,5</td> <td>2</td> <td>2</td> </tr> </table>	mm ²	2,5	4	6	10	mm	5 ⁺¹	5 ⁺¹	8 ⁺¹	11 ⁺¹	mm ²	2,5	4	6	10	Nm	1,5	1,5	2	2
mm ²	2,5	4	6	10																				
mm	5 ⁺¹	5 ⁺¹	8 ⁺¹	11 ⁺¹																				
mm ²	2,5	4	6	10																				
Nm	1,5	1,5	2	2																				
Han® C, Crimp contact, silver plated contacts, contact resistance ≤1 mOhm 	1.5 2.5 4 6 10	09 32 000 6104 09 32 000 6105 09 32 000 6107 09 32 000 6108 09 32 000 6109	09 32 000 6204 09 32 000 6205 09 32 000 6207 09 32 000 6208 09 32 000 6209	 <table border="1" data-bbox="1013 1870 1460 2004"> <thead> <tr> <th>Wire gauge</th> <th>∅</th> <th>Stripping length</th> </tr> </thead> <tbody> <tr> <td>1.5 mm² AWG 16</td> <td>1.75</td> <td>9.5 mm</td> </tr> <tr> <td>2.5 mm² AWG 14</td> <td>2.25</td> <td>9.5 mm</td> </tr> <tr> <td>4 mm² AWG 12</td> <td>2.85</td> <td>9.5 mm</td> </tr> <tr> <td>6 mm² AWG 10</td> <td>3.5</td> <td>9.5 mm</td> </tr> <tr> <td>10 mm² AWG 8</td> <td>4.3</td> <td>12 mm</td> </tr> </tbody> </table>	Wire gauge	∅	Stripping length	1.5 mm ² AWG 16	1.75	9.5 mm	2.5 mm ² AWG 14	2.25	9.5 mm	4 mm ² AWG 12	2.85	9.5 mm	6 mm ² AWG 10	3.5	9.5 mm	10 mm ² AWG 8	4.3	12 mm		
Wire gauge	∅	Stripping length																						
1.5 mm ² AWG 16	1.75	9.5 mm																						
2.5 mm ² AWG 14	2.25	9.5 mm																						
4 mm ² AWG 12	2.85	9.5 mm																						
6 mm ² AWG 10	3.5	9.5 mm																						
10 mm ² AWG 8	4.3	12 mm																						

Features

- Standard module for power up to 40 A
- No special tools required for axial-screw termination

Derating

Current carrying capacity

The current carrying capacity of the connectors is limited by the thermal load capability of the contact element material including the connections and the insulating parts. The derating curve is therefore valid for currents which flow constantly (non-intermittent) through each contact element of the connector evenly, without exceeding the allowed maximum temperature.

Measuring and testing techniques acc. to IEC 60512-5-2

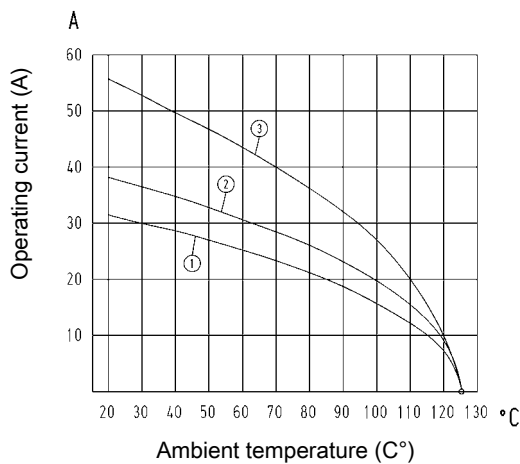

- ① 24 B hoods/housings with 6 modules Wire cross section 4 mm²
- ② 24 B hoods/housings with 6 modules Wire cross section 6 mm²
- ③ 24 B hoods/housings with 6 modules Wire cross section 10 mm²

Technical characteristics

Contacts	3
Electrical data acc. to IEC 61984	40 A 690 V 8 kV 3
Rated current	40 A
Rated voltage	690 V
Rated impulse voltage	8 kV
Pollution degree	3
Rated current acc. to UL	40 A
Rated voltage acc. to UL	600 V
Insulation resistance	≥10 ¹⁰ Ohm
Limiting temperatures	-40 °C ... 125 °C
Flammability (insert) acc. to UL 94	V 0
Mating cycles	≥500
Material (insert)	polycarbonate
Colour (insert)	RAL 7032 (light grey)
Material (contact)	copper alloy
Hex key	SW 2

Specifications and approvals

IEC 60664-1
IEC 61984



Details

Crimping tools see chapter 90

Remarks on the crimp technique





The wire gauges mentioned in the catalogue refer to geometric wire gauges of cables.

Number of contacts

3

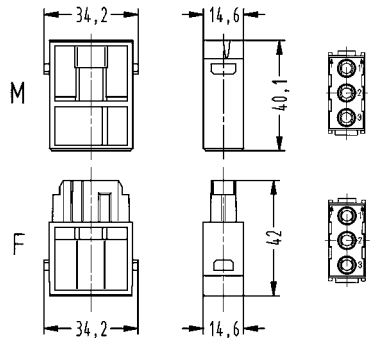
690 V
40 A

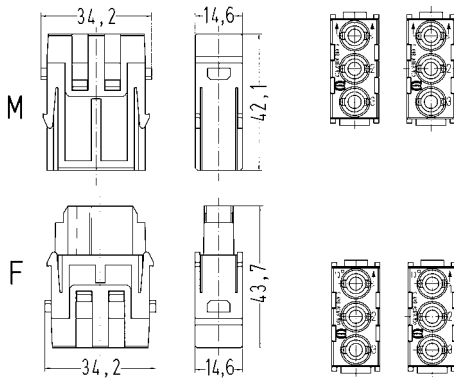
Han-Modular

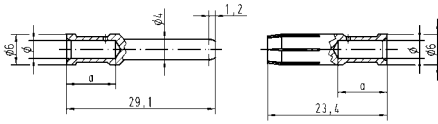
Identification	Wire cross section (mm ²)	Part number		Drawing Dimensions in mm																				
		male	female																					
Han-Modular®, Han® C module, Crimp terminal  Please order crimp contacts separately.		09 14 003 3001	09 14 003 3101	 Contact arrangement (view from termination side)																				
Han-Modular®, Han® C module, Axial screw terminal, silver plated contacts, contact resistance ≤0.3 mOhm 	2.5–8 6–10	09 14 003 2601 09 14 003 2602	09 14 003 2701 09 14 003 2702	 Stripping length <table border="1" data-bbox="1157 1523 1460 1579"> <tr> <td>mm²</td> <td>2,5</td> <td>4</td> <td>6</td> <td>10</td> </tr> <tr> <td>mm</td> <td>5⁺¹</td> <td>5⁺¹</td> <td>8⁺¹</td> <td>11⁺¹</td> </tr> </table> Tightening torque <table border="1" data-bbox="1157 1601 1460 1657"> <tr> <td>mm²</td> <td>2,5</td> <td>4</td> <td>6</td> <td>10</td> </tr> <tr> <td>Nm</td> <td>1,5</td> <td>1,5</td> <td>2</td> <td>2</td> </tr> </table>	mm ²	2,5	4	6	10	mm	5 ⁺¹	5 ⁺¹	8 ⁺¹	11 ⁺¹	mm ²	2,5	4	6	10	Nm	1,5	1,5	2	2
mm ²	2,5	4	6	10																				
mm	5 ⁺¹	5 ⁺¹	8 ⁺¹	11 ⁺¹																				
mm ²	2,5	4	6	10																				
Nm	1,5	1,5	2	2																				
Han® C, Crimp contact, silver plated contacts, contact resistance ≤1 mOhm 	1.5 2.5 4 6 10	09 32 000 6104 09 32 000 6105 09 32 000 6107 09 32 000 6108 09 32 000 6109	09 32 000 6204 09 32 000 6205 09 32 000 6207 09 32 000 6208 09 32 000 6209	 <table border="1" data-bbox="1005 1870 1460 2004"> <thead> <tr> <th>Wire gauge</th> <th>∅</th> <th>Stripping length</th> </tr> </thead> <tbody> <tr> <td>1.5 mm² AWG 16</td> <td>1.75</td> <td>9.5 mm</td> </tr> <tr> <td>2.5 mm² AWG 14</td> <td>2.25</td> <td>9.5 mm</td> </tr> <tr> <td>4 mm² AWG 12</td> <td>2.85</td> <td>9.5 mm</td> </tr> <tr> <td>6 mm² AWG 10</td> <td>3.5</td> <td>9.5 mm</td> </tr> <tr> <td>10 mm² AWG 8</td> <td>4.3</td> <td>12 mm</td> </tr> </tbody> </table>	Wire gauge	∅	Stripping length	1.5 mm ² AWG 16	1.75	9.5 mm	2.5 mm ² AWG 14	2.25	9.5 mm	4 mm ² AWG 12	2.85	9.5 mm	6 mm ² AWG 10	3.5	9.5 mm	10 mm ² AWG 8	4.3	12 mm		
Wire gauge	∅	Stripping length																						
1.5 mm ² AWG 16	1.75	9.5 mm																						
2.5 mm ² AWG 14	2.25	9.5 mm																						
4 mm ² AWG 12	2.85	9.5 mm																						
6 mm ² AWG 10	3.5	9.5 mm																						
10 mm ² AWG 8	4.3	12 mm																						

Features

- Suitable for Han® C crimp contacts
- Designed for a high working voltage up to 830 V
- Finger safe male and female contacts
- High density of contacts

Derating

Current carrying capacity

The current carrying capacity of the connectors is limited by the thermal load capability of the contact element material including the connections and the insulating parts. The derating curve is therefore valid for currents which flow constantly (non-intermittent) through each contact element of the connector evenly, without exceeding the allowed maximum temperature.

Measuring and testing techniques acc. to IEC 60512-5-2

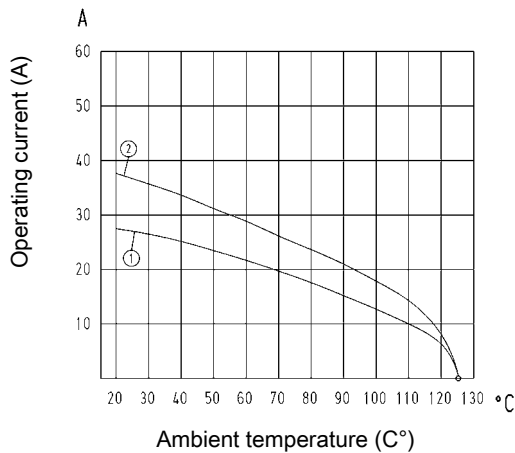

- ① 24 B hoods/housings with 6 modules Wire cross section 4 mm²
- ② 24 B hoods/housings with 6 modules Wire cross section 6 mm²

Technical characteristics

Contacts	4
Electrical data acc. to IEC 61984	40 A 830 V 8 kV 3
Rated current	40 A
Rated voltage	830 V
Rated impulse voltage	8 kV
Pollution degree	3
Rated voltage acc. to UL	600 V
Insulation resistance	≥10 ¹⁰ Ohm
Limiting temperatures	-40 °C ... 125 °C
Flammability (insert) acc. to UL 94	V 0
Mating cycles	≥500
Material (insert)	polycarbonate
Colour (insert)	RAL 7032 (light grey)
Material (contact)	copper alloy

Specifications and approvals

IEC 60664-1
IEC 61984



Details

Crimping tools see chapter 90

Remarks on the crimp technique

The wire gauges mentioned in the catalogue refer to geometric wire gauges of cables.

Number of contacts

4

830 V
40 A

Identification	Wire cross section (mm²)	Part number		Drawing Dimensions in mm																		
		male	female																			
<p>Han-Modular®, Han® CC Protected module, Crimp terminal</p> <p>Please order crimp contacts separately.</p>		09 14 004 3041	09 14 004 3141																			
<p>Han® C, Crimp contact, silver plated contacts, contact resistance ≤1 mOhm</p>	1.5 2.5 4 6	09 32 000 6104 09 32 000 6105 09 32 000 6107 09 32 000 6108	09 32 000 6204 09 32 000 6205 09 32 000 6207 09 32 000 6208	<table border="1"> <thead> <tr> <th>Wire gauge</th> <th>Ø</th> <th>Stripping length</th> </tr> </thead> <tbody> <tr> <td>1.5 mm² AWG 16</td> <td>1.75</td> <td>9.5 mm</td> </tr> <tr> <td>2.5 mm² AWG 14</td> <td>2.25</td> <td>9.5 mm</td> </tr> <tr> <td>4 mm² AWG 12</td> <td>2.85</td> <td>9.5 mm</td> </tr> <tr> <td>6 mm² AWG 10</td> <td>3.5</td> <td>9.5 mm</td> </tr> <tr> <td>10 mm² AWG 8</td> <td>4.3</td> <td>12 mm</td> </tr> </tbody> </table>	Wire gauge	Ø	Stripping length	1.5 mm² AWG 16	1.75	9.5 mm	2.5 mm² AWG 14	2.25	9.5 mm	4 mm² AWG 12	2.85	9.5 mm	6 mm² AWG 10	3.5	9.5 mm	10 mm² AWG 8	4.3	12 mm
Wire gauge	Ø	Stripping length																				
1.5 mm² AWG 16	1.75	9.5 mm																				
2.5 mm² AWG 14	2.25	9.5 mm																				
4 mm² AWG 12	2.85	9.5 mm																				
6 mm² AWG 10	3.5	9.5 mm																				
10 mm² AWG 8	4.3	12 mm																				

Han-Modular

Features

- 3 contacts (40 A) for power circuits and 4 contacts (10 A) for signal circuits
- Ideal as motor drive connector
- Finger safe male and female contacts

Derating

Current carrying capacity

The current carrying capacity of the connectors is limited by the thermal load capability of the contact element material including the connections and the insulating parts. The derating curve is therefore valid for currents which flow constantly (non-intermittent) through each contact element of the connector evenly, without exceeding the allowed maximum temperature.

Measuring and testing techniques acc. to IEC 60512-5-2

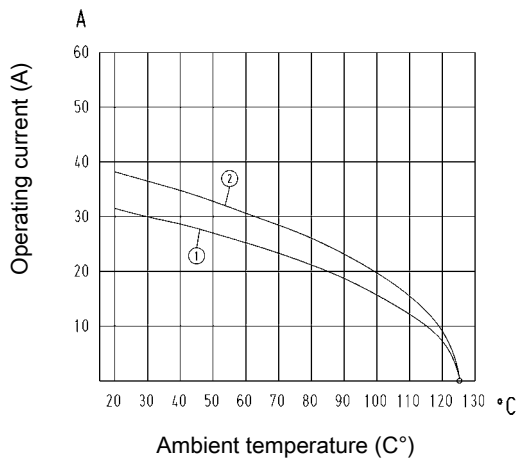

- ① 24 B hoods/housings with 6 modules Wire cross section 4 mm²
- ② 24 B hoods/housings with 6 modules Wire cross section 6 mm²

Technical characteristics

Contacts	3/4
Electrical data acc. to IEC 61984	40 A 830 V 8 kV 3
Rated current	40 A
Rated voltage	830 V
Rated impulse voltage	8 kV
Pollution degree	3
Electrical data, signal	10 A 830 V 8 kV 3
Rated current	10 A
Rated voltage	830 V
Rated impulse voltage	8 kV
Rated voltage acc. to UL	600 V
Insulation resistance	≥10 ¹⁰ Ohm
Limiting temperatures	-40 °C ... 125 °C
Flammability (insert) acc. to UL 94	V 0
Mating cycles	≥500
Material (insert)	polycarbonate
Colour (insert)	RAL 7032 (light grey)
Material (contact)	copper alloy

Specifications and approvals

IEC 60664-1
IEC 61984



Details

Crimping tools see chapter 90

Remarks on the crimp technique





The wire gauges mentioned in the catalogue refer to geometric wire gauges of cables.

Number of contacts

3/4

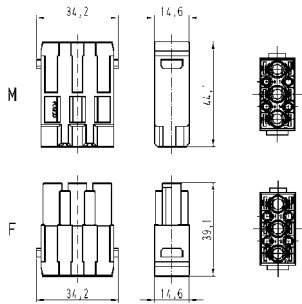
830 V / 830 V
40 A/10 A

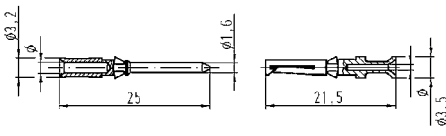
Han-
Modular

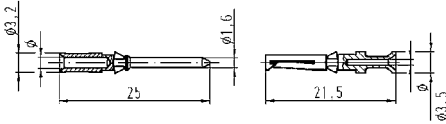
Identification	Wire cross section (mm²)	Part number		Drawing Dimensions in mm																					
		male	female																						
Han-Modular®, Han® CD module, Crimp terminal  Please order crimp contacts separately.		09 14 007 3001	09 14 007 3101	 Contact arrangement (view from termination side) Max. insulation diameter 5 mm																					
Han D®, Crimp contact, gold plated contacts, contact resistance ≤3 mOhm 	0.14–0.37 0.5 0.75 1 1.5 2.5	09 15 000 6124 09 15 000 6123 09 15 000 6125 09 15 000 6122 09 15 000 6121 09 15 000 6126	09 15 000 6224 09 15 000 6223 09 15 000 6225 09 15 000 6222 09 15 000 6221 09 15 000 6226	 <table border="1"> <thead> <tr> <th>Wire gauge</th> <th>∅</th> <th>Stripping length</th> </tr> </thead> <tbody> <tr> <td>0.14-0.37 mm² AWG 26-22</td> <td>0.9 mm</td> <td>8 mm</td> </tr> <tr> <td>0.5 mm² AWG 20</td> <td>1.1 mm</td> <td>8 mm</td> </tr> <tr> <td>0.75 mm² AWG 18</td> <td>1.3 mm</td> <td>8 mm</td> </tr> <tr> <td>1 mm² AWG 18</td> <td>1.45 mm</td> <td>8 mm</td> </tr> <tr> <td>1.5 mm² AWG 16</td> <td>1.75 mm</td> <td>8 mm</td> </tr> <tr> <td>2.5 mm² AWG 14</td> <td>2.25 mm</td> <td>6 mm</td> </tr> </tbody> </table>	Wire gauge	∅	Stripping length	0.14-0.37 mm² AWG 26-22	0.9 mm	8 mm	0.5 mm² AWG 20	1.1 mm	8 mm	0.75 mm² AWG 18	1.3 mm	8 mm	1 mm² AWG 18	1.45 mm	8 mm	1.5 mm² AWG 16	1.75 mm	8 mm	2.5 mm² AWG 14	2.25 mm	6 mm
Wire gauge	∅	Stripping length																							
0.14-0.37 mm² AWG 26-22	0.9 mm	8 mm																							
0.5 mm² AWG 20	1.1 mm	8 mm																							
0.75 mm² AWG 18	1.3 mm	8 mm																							
1 mm² AWG 18	1.45 mm	8 mm																							
1.5 mm² AWG 16	1.75 mm	8 mm																							
2.5 mm² AWG 14	2.25 mm	6 mm																							
Han D®, Crimp contact, silver plated contacts, contact resistance ≤3 mOhm 	0.14–0.37 0.5 0.75 1 1.5 2.5	09 15 000 6104 09 15 000 6103 09 15 000 6105 09 15 000 6102 09 15 000 6101 09 15 000 6106	09 15 000 6204 09 15 000 6203 09 15 000 6205 09 15 000 6202 09 15 000 6201 09 15 000 6206	 <table border="1"> <thead> <tr> <th>Wire gauge</th> <th>∅</th> <th>Stripping length</th> </tr> </thead> <tbody> <tr> <td>0.14-0.37 mm² AWG 26-22</td> <td>0.9 mm</td> <td>8 mm</td> </tr> <tr> <td>0.5 mm² AWG 20</td> <td>1.1 mm</td> <td>8 mm</td> </tr> <tr> <td>0.75 mm² AWG 18</td> <td>1.3 mm</td> <td>8 mm</td> </tr> <tr> <td>1 mm² AWG 18</td> <td>1.45 mm</td> <td>8 mm</td> </tr> <tr> <td>1.5 mm² AWG 16</td> <td>1.75 mm</td> <td>8 mm</td> </tr> <tr> <td>2.5 mm² AWG 14</td> <td>2.25 mm</td> <td>6 mm</td> </tr> </tbody> </table>	Wire gauge	∅	Stripping length	0.14-0.37 mm² AWG 26-22	0.9 mm	8 mm	0.5 mm² AWG 20	1.1 mm	8 mm	0.75 mm² AWG 18	1.3 mm	8 mm	1 mm² AWG 18	1.45 mm	8 mm	1.5 mm² AWG 16	1.75 mm	8 mm	2.5 mm² AWG 14	2.25 mm	6 mm
Wire gauge	∅	Stripping length																							
0.14-0.37 mm² AWG 26-22	0.9 mm	8 mm																							
0.5 mm² AWG 20	1.1 mm	8 mm																							
0.75 mm² AWG 18	1.3 mm	8 mm																							
1 mm² AWG 18	1.45 mm	8 mm																							
1.5 mm² AWG 16	1.75 mm	8 mm																							
2.5 mm² AWG 14	2.25 mm	6 mm																							

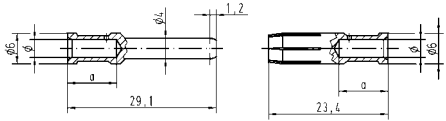
Identification	Wire cross section (mm ²)	Part number		Drawing Dimensions in mm																		
		male	female																			
Han® C, Crimp contact, silver plated contacts, contact resistance ≤1 mOhm 	1.5	09 32 000 6104	09 32 000 6204	 <table border="1"> <thead> <tr> <th>Wire gauge</th> <th>∅</th> <th>Stripping length</th> </tr> </thead> <tbody> <tr> <td>1.5 mm² AWG 16</td> <td>1.75</td> <td>9.5 mm</td> </tr> <tr> <td>2.5 mm² AWG 14</td> <td>2.25</td> <td>9.5 mm</td> </tr> <tr> <td>4 mm² AWG 12</td> <td>2.85</td> <td>9.5 mm</td> </tr> <tr> <td>6 mm² AWG 10</td> <td>3.5</td> <td>9.5 mm</td> </tr> <tr> <td>10 mm² AWG 8</td> <td>4.3</td> <td>12 mm</td> </tr> </tbody> </table>	Wire gauge	∅	Stripping length	1.5 mm ² AWG 16	1.75	9.5 mm	2.5 mm ² AWG 14	2.25	9.5 mm	4 mm ² AWG 12	2.85	9.5 mm	6 mm ² AWG 10	3.5	9.5 mm	10 mm ² AWG 8	4.3	12 mm
	Wire gauge	∅	Stripping length																			
	1.5 mm ² AWG 16	1.75	9.5 mm																			
	2.5 mm ² AWG 14	2.25	9.5 mm																			
4 mm ² AWG 12	2.85	9.5 mm																				
6 mm ² AWG 10	3.5	9.5 mm																				
10 mm ² AWG 8	4.3	12 mm																				
2.5	09 32 000 6105	09 32 000 6205																				
4	09 32 000 6107	09 32 000 6207																				
6	09 32 000 6108	09 32 000 6208																				

Features

- Standard module for power up to 16 A
- Han-Quick Lock[®] or Crimp terminal available

Derating

Current carrying capacity

The current carrying capacity of the connectors is limited by the thermal load capability of the contact element material including the connections and the insulating parts. The derating curve is therefore valid for currents which flow constantly (non-intermittent) through each contact element of the connector evenly, without exceeding the allowed maximum temperature.

Measuring and testing techniques acc. to IEC 60512-5-2

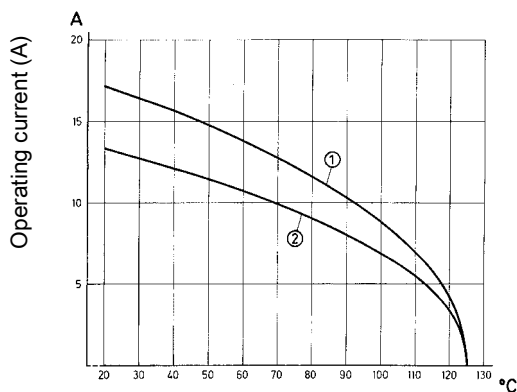

Ambient temperature (C°)

- ① 24 B hoods/housings with 6 modules Wire cross section 2.5 mm²
- ② 24 B hoods/housings with 6 modules Wire cross section 1.5 mm²

Technical characteristics

Contacts	6
Electrical data acc. to IEC 61984	16 A 500 V 6 kV 3
Rated current	16 A
Rated voltage	500 V
Rated impulse voltage	6 kV
Pollution degree	3
Rated voltage acc. to UL	600 V
Insulation resistance	≥10 ¹⁰ Ohm
Limiting temperatures	-40 °C ... 125 °C
Flammability (insert) acc. to UL 94	V 0
Mating cycles	≥500
Mating cycles with HMC contacts	≥10000
Material (insert)	polycarbonate
Colour (insert)	RAL 7032 (light grey)
Material (contact)	copper alloy

Specifications and approvals

IEC 60664-1
IEC 61984



Details

Crimping tools see chapter 90

Remarks on the crimp technique





The wire gauges mentioned in the catalogue refer to geometric wire gauges of cables.

Designed for 10,000 mating cycles (only with Han E[®] HMC crimp contacts, Han-Modular[®] Docking frame and Han-Modular[®] Hinged frame HMC)

Number of contacts

6

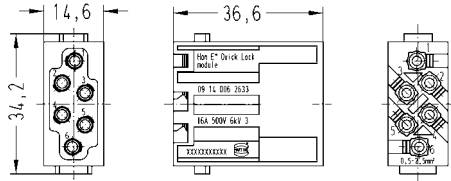
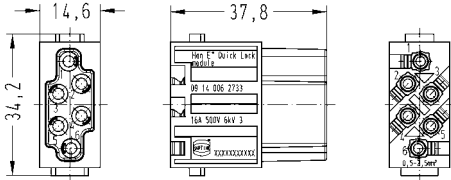
500 V
16 A

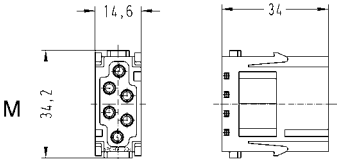
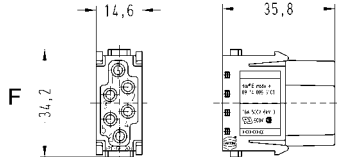
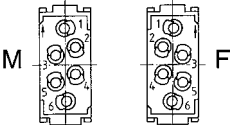
Identification	Wire cross section (mm ²)	Part number male female		Drawing Dimensions in mm
<p> Han-Quick Lock[®] Han-Modular[®], Han E[®] module, Han-Quick Lock[®] termination, silver plated contacts, contact resistance ≤1 mOhm</p> 	0.5–2.5	09 14 006 2633	09 14 006 2733	  <p>Contact arrangement (view from termination side)</p>
<p>Han-Modular[®], Han E[®] module, Crimp terminal</p>  <p>Please order crimp contacts separately.</p>		09 14 006 3001	09 14 006 3101	   <p>Contact arrangement (view from termination side)</p>

Han-Modular

Identification	Wire cross section (mm ²)	Part number	
		male	female
Han E®, Crimp contact, gold plated contacts, contact resistance ≤1 mOhm	0.14–0.37	09 33 000 6117	09 33 000 6217
	0.5	09 33 000 6122	09 33 000 6222
	0.75	09 33 000 6115	09 33 000 6215
	1	09 33 000 6118	09 33 000 6218
	1.5	09 33 000 6116	09 33 000 6216
	2.5	09 33 000 6123	09 33 000 6223
	4	09 33 000 6119	09 33 000 6221

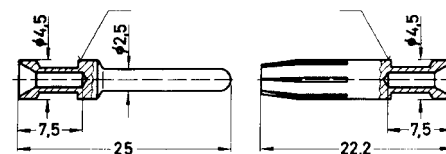

Identification	Wire gauge	Stripping length
no groove	0.14–0.37 mm ² AWG 26–22	7.5 mm
no groove	0.5 mm ² AWG 20	7.5 mm
1 groove*	0.75 mm ² AWG 18	7.5 mm
1 groove	1 mm ² AWG 18	7.5 mm
2 grooves	1.5 mm ² AWG 16	7.5 mm
3 grooves	2.5 mm ² AWG 14	7.5 mm
wide groove	3 mm ² AWG 12	7.5 mm
no groove	4 mm ² AWG 12	7.5 mm

* on the back crimp collar

Identification	Wire cross section (mm ²)	Part number	
		male	female
Han E®, Crimp contact, silver plated contacts, contact resistance ≤1 mOhm	0.14–0.37	09 33 000 6127	09 33 000 6227
	0.5	09 33 000 6121	09 33 000 6220
	0.75	09 33 000 6114	09 33 000 6214
	1	09 33 000 6105	09 33 000 6205
	1.5	09 33 000 6104	09 33 000 6204
	2.5	09 33 000 6102	09 33 000 6202
	3	09 33 000 6106	09 33 000 6206
4	09 33 000 6107	09 33 000 6207	

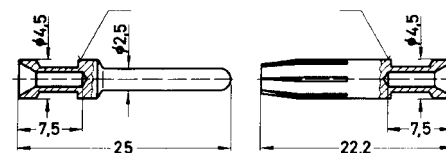

Identification	Wire gauge	Stripping length
no groove	0.14–0.37 mm ² AWG 26–22	7.5 mm
no groove	0.5 mm ² AWG 20	7.5 mm
1 groove*	0.75 mm ² AWG 18	7.5 mm
1 groove	1 mm ² AWG 18	7.5 mm
2 grooves	1.5 mm ² AWG 16	7.5 mm
3 grooves	2.5 mm ² AWG 14	7.5 mm
wide groove	3 mm ² AWG 12	7.5 mm
no groove	4 mm ² AWG 12	7.5 mm

* on the back crimp collar

Features

- Screw connection, suitable for all users around the world
- No special tools required
- For flexible and solid conductors from 0.5 to 2.5 mm²
- Additional protection against voltage and accidental contact by a sliding insulation cover which closes automatically during mating

Derating

Current carrying capacity

The current carrying capacity of the connectors is limited by the thermal load capability of the contact element material including the connections and the insulating parts. The derating curve is therefore valid for currents which flow constantly (non-intermittent) through each contact element of the connector evenly, without exceeding the allowed maximum temperature.

Measuring and testing techniques acc. to IEC 60512-5-2

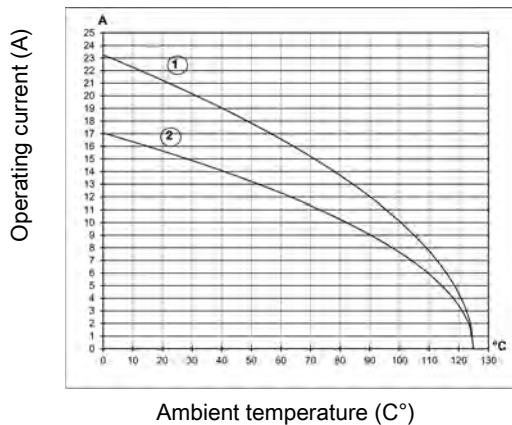

Technical characteristics

Contacts	5
Electrical data acc. to IEC 61984	16 A 230/400 V 4 kV 3
Rated current	16 A
Rated voltage conductor - ground	230 V
Rated voltage conductor - conductor	400 V
Rated impulse voltage	4 kV
Pollution degree	3
Insulation resistance	≥10 ¹⁰ Ohm
Limiting temperatures	-40 °C ... 125 °C
Flammability (insert) acc. to UL 94	V 0
Mating cycles	≥500
Material (insert)	polycarbonate
Colour (insert)	RAL 7032 (light grey)
Material (contact)	copper alloy

Specifications and approvals

IEC 60664-1
IEC 61984



Number of contacts

5

230/400 V
16 A

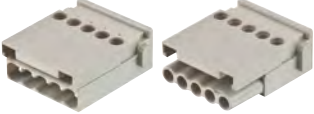
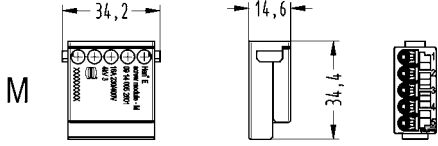
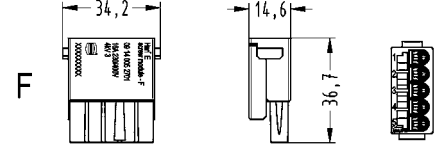
Identification	Wire cross section (mm ²)	Part number		Drawing Dimensions in mm
		male	female	
<p>Han-Modular®, Han E® module, Screw terminal, silver plated contacts, contact resistance ≤1 mOhm</p> 	0.5-2.5	09 14 005 2601	09 14 005 2701	<div style="display: flex; flex-direction: column; align-items: center;"> <div style="margin-bottom: 10px;"> <p>M</p>  </div> <div> <p>F</p>  </div> </div>

Han-Modular

Features

- Suitable for Han E[®] crimp contacts
- Designed for a high working voltage up to 830 V
- Finger safe male and female contacts

Derating

Current carrying capacity

The current carrying capacity of the connectors is limited by the thermal load capability of the contact element material including the connections and the insulating parts. The derating curve is therefore valid for currents which flow constantly (non-intermittent) through each contact element of the connector evenly, without exceeding the allowed maximum temperature.

Measuring and testing techniques acc. to IEC 60512-5-2

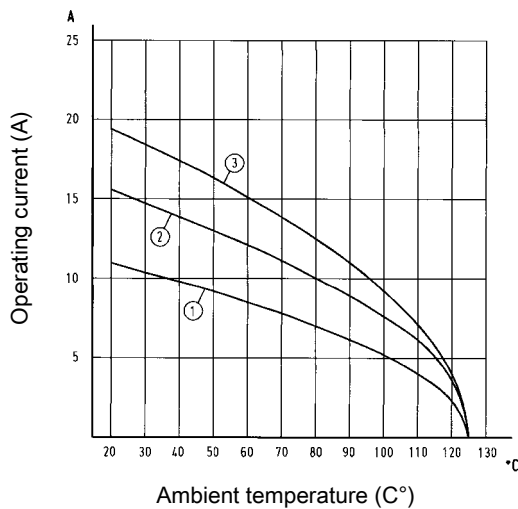

- ① 24 B hoods/housings with 6 modules Wire cross section 1.5 mm²
- ② 24 B hoods/housings with 6 modules Wire cross section 2.5 mm²
- ③ 24 B hoods/housings with 6 modules Wire cross section 4 mm²

Technical characteristics

Contacts	6
Electrical data acc. to IEC 61984	16 A 830 V 8 kV 3
Rated current	16 A
Rated voltage	830 V
Rated impulse voltage	8 kV
Pollution degree	3
Rated voltage acc. to UL	600 V
Insulation resistance	≥10 ¹⁰ Ohm
Limiting temperatures	-40 °C ... 125 °C
Flammability (insert) acc. to UL 94	V 0
Mating cycles	≥500
Mating cycles with HMC contacts	≥10000
Material (insert)	polycarbonate
Colour (insert)	RAL 7032 (light grey)
Material (contact)	copper alloy

Specifications and approvals

IEC 60664-1
IEC 61984



Details

Crimping tools see chapter 90

Remarks on the crimp technique

The wire gauges mentioned in the catalogue refer to geometric wire gauges of cables.



Designed for 10,000 mating cycles (only with Han E[®] HMC crimp contacts, Han-Modular[®] Docking frame and Han-Modular[®] Hinged frame HMC)

Number of contacts

6

830 V
16 A

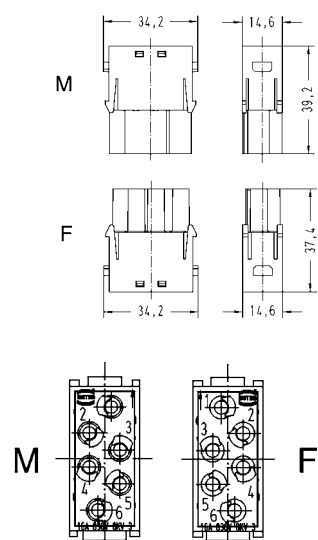
Han-Modular

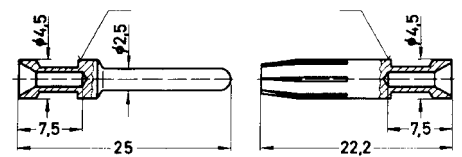
Identification	Wire cross section (mm ²)	Part number		Drawing Dimensions in mm																											
		male	female																												
Han-Modular®, Han E® Protected module, Crimp terminal  Please order crimp contacts separately.		09 14 006 3041	09 14 006 3141	 Contact arrangement (view from termination side)																											
Han E®, Crimp contact, gold plated contacts, contact resistance ≤1 mOhm 	0.14–0.37 0.5 0.75 1 1.5 2.5 4	09 33 000 6117 09 33 000 6122 09 33 000 6115 09 33 000 6118 09 33 000 6116 09 33 000 6123 09 33 000 6119	09 33 000 6217 09 33 000 6222 09 33 000 6215 09 33 000 6218 09 33 000 6216 09 33 000 6223 09 33 000 6221	 <table border="1"> <thead> <tr> <th>Identification</th> <th>Wire gauge</th> <th>Stripping length</th> </tr> </thead> <tbody> <tr> <td>no groove</td> <td>0.14-0.37 mm² AWG 26-22</td> <td>7.5 mm</td> </tr> <tr> <td>no groove</td> <td>0.5 mm² AWG 20</td> <td>7.5 mm</td> </tr> <tr> <td>1 groove*</td> <td>0.75 mm² AWG 18</td> <td>7.5 mm</td> </tr> <tr> <td>1 groove</td> <td>1 mm² AWG 18</td> <td>7.5 mm</td> </tr> <tr> <td>2 grooves</td> <td>1.5 mm² AWG 16</td> <td>7.5 mm</td> </tr> <tr> <td>3 grooves</td> <td>2.5 mm² AWG 14</td> <td>7.5 mm</td> </tr> <tr> <td>wide groove</td> <td>3 mm² AWG 12</td> <td>7.5 mm</td> </tr> <tr> <td>no groove</td> <td>4 mm² AWG 12</td> <td>7.5 mm</td> </tr> </tbody> </table> <p>* on the back crimp collar</p>	Identification	Wire gauge	Stripping length	no groove	0.14-0.37 mm ² AWG 26-22	7.5 mm	no groove	0.5 mm ² AWG 20	7.5 mm	1 groove*	0.75 mm ² AWG 18	7.5 mm	1 groove	1 mm ² AWG 18	7.5 mm	2 grooves	1.5 mm ² AWG 16	7.5 mm	3 grooves	2.5 mm ² AWG 14	7.5 mm	wide groove	3 mm ² AWG 12	7.5 mm	no groove	4 mm ² AWG 12	7.5 mm
Identification	Wire gauge	Stripping length																													
no groove	0.14-0.37 mm ² AWG 26-22	7.5 mm																													
no groove	0.5 mm ² AWG 20	7.5 mm																													
1 groove*	0.75 mm ² AWG 18	7.5 mm																													
1 groove	1 mm ² AWG 18	7.5 mm																													
2 grooves	1.5 mm ² AWG 16	7.5 mm																													
3 grooves	2.5 mm ² AWG 14	7.5 mm																													
wide groove	3 mm ² AWG 12	7.5 mm																													
no groove	4 mm ² AWG 12	7.5 mm																													

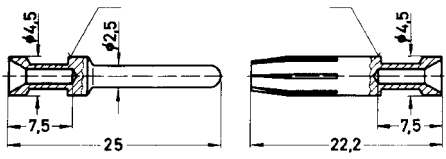
Identification	Wire cross section (mm ²)	Part number		Drawing Dimensions in mm
		male	female	
Han E [®] , Crimp contact, silver plated contacts, contact resistance ≤1 mOhm 	0.14–0.37	09 33 000 6127	09 33 000 6227	
	0.5	09 33 000 6121	09 33 000 6220	
	0.75	09 33 000 6114	09 33 000 6214	
	1	09 33 000 6105	09 33 000 6205	
	1.5	09 33 000 6104	09 33 000 6204	
	2.5	09 33 000 6102	09 33 000 6202	
	3	09 33 000 6106	09 33 000 6206	
	4	09 33 000 6107	09 33 000 6207	

Identification	Wire gauge	Stripping length
no groove	0.14-0.37 mm ² AWG 26-22	7.5 mm
no groove	0.5 mm ² AWG 20	7.5 mm
1 groove*	0.75 mm ² AWG 18	7.5 mm
1 groove	1 mm ² AWG 18	7.5 mm
2 grooves	1.5 mm ² AWG 16	7.5 mm
3 grooves	2.5 mm ² AWG 14	7.5 mm
wide groove	3 mm ² AWG 12	7.5 mm
no groove	4 mm ² AWG 12	7.5 mm

* on the back crimp collar

Features

- Han-Quick Lock® or Crimp terminal available
- High contact density

Derating

Current carrying capacity

The current carrying capacity of the connectors is limited by the thermal load capability of the contact element material including the connections and the insulating parts. The derating curve is therefore valid for currents which flow constantly (non-intermittent) through each contact element of the connector evenly, without exceeding the allowed maximum temperature.

Measuring and testing techniques acc. to IEC 60512-5-2

Quick Lock termination

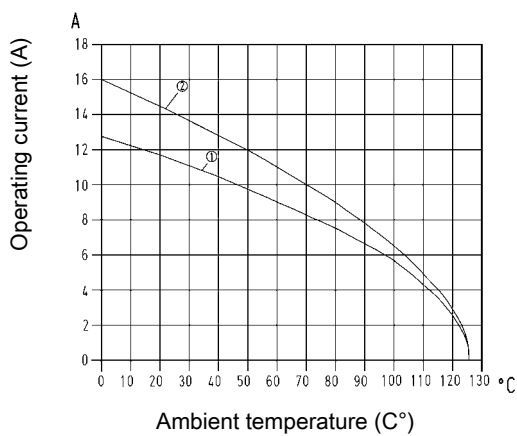

- ① 24 B hoods/housings with 6 modules Wire cross section 1.5 mm²
- ② 24 B hoods/housings with 6 modules Wire cross section 2.5 mm²

Crimp terminal

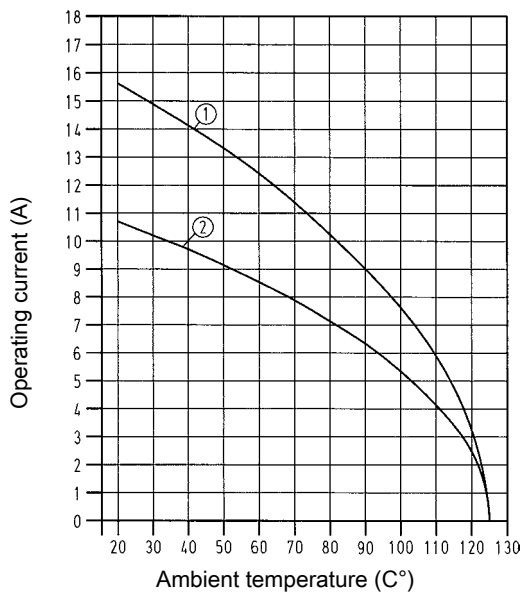

- ① 24 B hoods/housings with 6 modules Wire cross section 2.5 mm²
- ② 24 B hoods/housings with 6 modules Wire cross section 1.5 mm²

Technical characteristics

Contacts	8
Electrical data acc. to IEC 61984	blue slide 16 A 400 V 6 kV 3
	black slide 16 A 400 V 6 kV 3
	16 A 400 V 6 kV 3
Rated current	16 A
Rated voltage	400 V
Rated impulse voltage	6 kV
Pollution degree	3
Rated voltage acc. to UL	600 V
Insulation resistance	≥10 ¹⁰ Ohm
Limiting temperatures	-40 °C ... 125 °C
Flammability (insert) acc. to UL 94	V 0
Mating cycles	≥500
Mating cycles with HMC contacts	≥10000
Material (insert)	polycarbonate
Colour (insert)	RAL 7032 (light grey)
Material (contact)	copper alloy

Specifications and approvals

IEC 60664-1
IEC 61984



Details

Crimping tools see chapter 90

Remarks on the crimp technique



The wire gauges mentioned in the catalogue refer to geometric wire gauges of cables.

Designed for 10,000 mating cycles (only with Han E® HMC crimp contacts, Han-Modular® Docking frame and Han-Modular® Hinged frame HMC)

Number of contacts

8

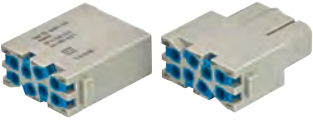
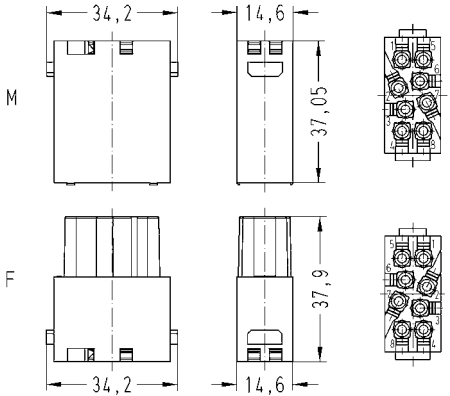
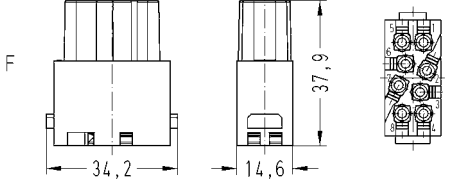
400 V
16 A

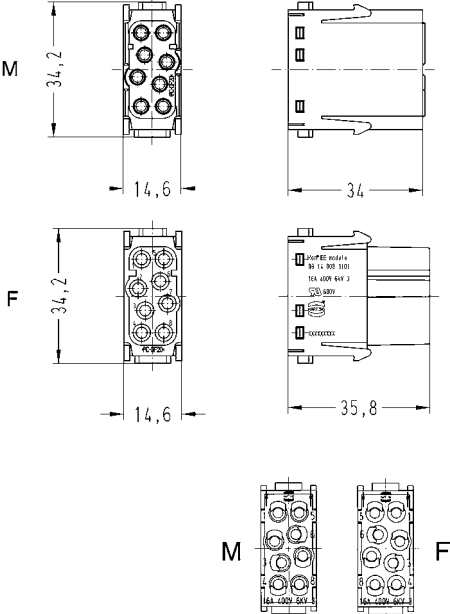
Identification	Wire cross section (mm²)	Part number		Drawing Dimensions in mm
		male	female	
<p> Han-Quick Lock® Han-Modular®, Han® EE module, Han-Quick Lock® termination, blue slide, silver plated contacts, contact resistance ≤1 mOhm</p> 	0.5 – 2.5	09 14 008 2633	09 14 008 2733	 <p>Contact arrangement (view from termination side)</p>
<p> Han-Quick Lock® Han® EE module, Han-Quick Lock® termination, black slide, silver plated contacts, contact resistance ≤1 mOhm</p>	0.25 – 1.5	09 14 008 2634	09 14 008 2734	 <p>Contact arrangement (view from termination side)</p>
<p>Han-Modular®, Han® EE module, Crimp terminal</p>  <p>Please order crimp contacts separately.</p>		09 14 008 3001	09 14 008 3101	 <p>Contact arrangement (view from termination side)</p>

Han-Modular

Identification	Wire cross section (mm ²)	Part number	
		male	female
Han E®, Crimp contact, gold plated contacts, contact resistance ≤1 mOhm	0.14–0.37	09 33 000 6117	09 33 000 6217
	0.5	09 33 000 6122	09 33 000 6222
	0.75	09 33 000 6115	09 33 000 6215
	1	09 33 000 6118	09 33 000 6218
	1.5	09 33 000 6116	09 33 000 6216
	2.5	09 33 000 6123	09 33 000 6223
	4	09 33 000 6119	09 33 000 6221



Drawing
Dimensions in mm

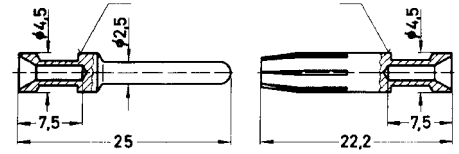

Identification	Wire gauge	Stripping length
no groove	0.14–0.37 mm ² AWG 26–22	7.5 mm
no groove	0.5 mm ² AWG 20	7.5 mm
1 groove*	0.75 mm ² AWG 18	7.5 mm
1 groove	1 mm ² AWG 18	7.5 mm
2 grooves	1.5 mm ² AWG 16	7.5 mm
3 grooves	2.5 mm ² AWG 14	7.5 mm
wide groove	3 mm ² AWG 12	7.5 mm
no groove	4 mm ² AWG 12	7.5 mm

* on the back crimp collar

Identification	Wire cross section (mm ²)	Part number	
		male	female
Han E®, Crimp contact, silver plated contacts, contact resistance ≤1 mOhm	0.14–0.37	09 33 000 6127	09 33 000 6227
	0.5	09 33 000 6121	09 33 000 6220
	0.75	09 33 000 6114	09 33 000 6214
	1	09 33 000 6105	09 33 000 6205
	1.5	09 33 000 6104	09 33 000 6204
	2.5	09 33 000 6102	09 33 000 6202
	3	09 33 000 6106	09 33 000 6206
	4	09 33 000 6107	09 33 000 6207

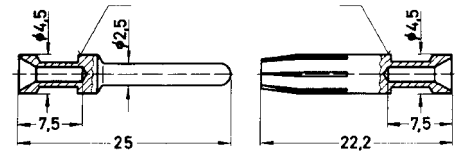
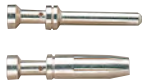

Identification	Wire gauge	Stripping length
no groove	0.14–0.37 mm ² AWG 26–22	7.5 mm
no groove	0.5 mm ² AWG 20	7.5 mm
1 groove*	0.75 mm ² AWG 18	7.5 mm
1 groove	1 mm ² AWG 18	7.5 mm
2 grooves	1.5 mm ² AWG 16	7.5 mm
3 grooves	2.5 mm ² AWG 14	7.5 mm
wide groove	3 mm ² AWG 12	7.5 mm
no groove	4 mm ² AWG 12	7.5 mm

* on the back crimp collar

Han-Modular

Features

- Suitable for Han E® crimp contacts
- Higher density of crimping contacts
- Standard module for power up to 16 A
- Also suitable as a reliable signal connector

Derating

Current carrying capacity

The current carrying capacity of the connectors is limited by the thermal load capability of the contact element material including the connections and the insulating parts. The derating curve is therefore valid for currents which flow constantly (non-intermittent) through each contact element of the connector evenly, without exceeding the allowed maximum temperature.

Measuring and testing techniques acc. to IEC 60512-5-2

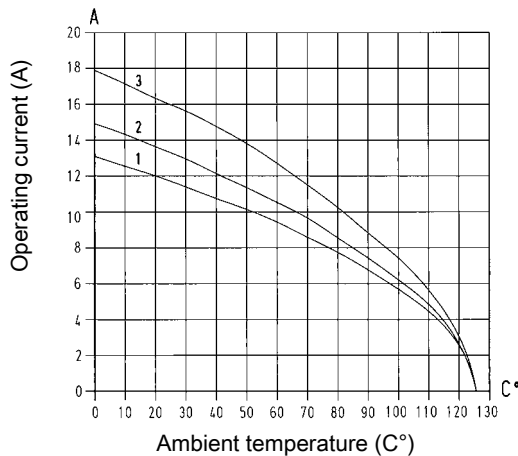

- ① 24 B hoods/housings with 3 modules Wire cross section 1.5 mm²
- ② 24 B hoods/housings with 3 modules Wire cross section 2.5 mm²
- ③ 24 B hoods/housings with 3 modules Wire cross section 4 mm²

Technical characteristics

Contacts	20
Electrical data acc. to IEC 61984	16 A 500 V 6 kV 3
Rated current	16 A
Rated voltage	500 V
Rated impulse voltage	6 kV
Pollution degree	3
Rated voltage acc. to UL	600 V
Insulation resistance	≥10 ¹⁰ Ohm
Limiting temperatures	-40 °C ... 125 °C
Flammability (insert) acc. to UL 94	V 0
Mating cycles	≥500
Mating cycles with HMC contacts	≥10000
Material (insert)	polycarbonate
Colour (insert)	RAL 7032 (light grey)
Material (contact)	copper alloy

Specifications and approvals

IEC 60664-1
IEC 61984



Details

Crimping tools see chapter 90

Remarks on the crimp technique



The wire gauges mentioned in the catalogue refer to geometric wire gauges of cables.

Designed for 10,000 mating cycles (only with Han E® HMC crimp contacts, Han-Modular® Docking frame and Han-Modular® Hinged frame HMC)

Number of contacts

20

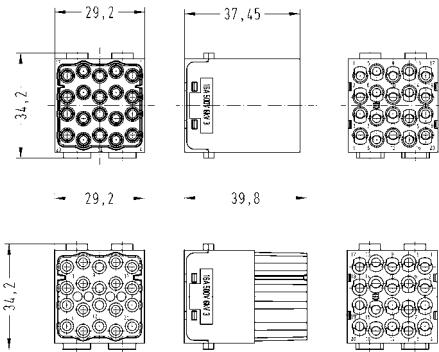
500 V
16 A

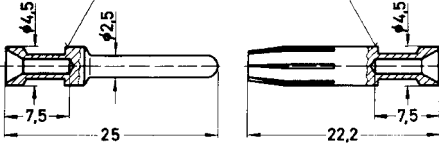
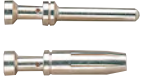
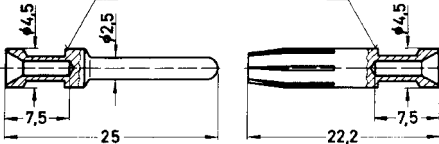
Identification	Wire cross section (mm ²)	Part number		Drawing Dimensions in mm																											
		male	female																												
Han-Modular®, Han® EEE module, Crimp terminal  Please order crimp contacts separately.		09 14 020 3001	09 14 020 3101	 Contact arrangement (view from termination side)																											
Han E®, Crimp contact, gold plated contacts, contact resistance ≤1 mOhm 	0.14–0.37 0.5 0.75 1 1.5 2.5 4	09 33 000 6117 09 33 000 6122 09 33 000 6115 09 33 000 6118 09 33 000 6116 09 33 000 6123 09 33 000 6119	09 33 000 6217 09 33 000 6222 09 33 000 6215 09 33 000 6218 09 33 000 6216 09 33 000 6223 09 33 000 6221	 <table border="1"> <thead> <tr> <th>Identification</th> <th>Wire gauge</th> <th>Stripping length</th> </tr> </thead> <tbody> <tr> <td>no groove</td> <td>0.14-0.37 mm² AWG 26-22</td> <td>7.5 mm</td> </tr> <tr> <td>no groove</td> <td>0.5 mm² AWG 20</td> <td>7.5 mm</td> </tr> <tr> <td>1 groove*</td> <td>0.75 mm² AWG 18</td> <td>7.5 mm</td> </tr> <tr> <td>1 groove</td> <td>1 mm² AWG 18</td> <td>7.5 mm</td> </tr> <tr> <td>2 grooves</td> <td>1.5 mm² AWG 16</td> <td>7.5 mm</td> </tr> <tr> <td>3 grooves</td> <td>2.5 mm² AWG 14</td> <td>7.5 mm</td> </tr> <tr> <td>wide groove</td> <td>3 mm² AWG 12</td> <td>7.5 mm</td> </tr> <tr> <td>no groove</td> <td>4 mm² AWG 12</td> <td>7.5 mm</td> </tr> </tbody> </table> <p>* on the back crimp collar</p>	Identification	Wire gauge	Stripping length	no groove	0.14-0.37 mm ² AWG 26-22	7.5 mm	no groove	0.5 mm ² AWG 20	7.5 mm	1 groove*	0.75 mm ² AWG 18	7.5 mm	1 groove	1 mm ² AWG 18	7.5 mm	2 grooves	1.5 mm ² AWG 16	7.5 mm	3 grooves	2.5 mm ² AWG 14	7.5 mm	wide groove	3 mm ² AWG 12	7.5 mm	no groove	4 mm ² AWG 12	7.5 mm
Identification	Wire gauge	Stripping length																													
no groove	0.14-0.37 mm ² AWG 26-22	7.5 mm																													
no groove	0.5 mm ² AWG 20	7.5 mm																													
1 groove*	0.75 mm ² AWG 18	7.5 mm																													
1 groove	1 mm ² AWG 18	7.5 mm																													
2 grooves	1.5 mm ² AWG 16	7.5 mm																													
3 grooves	2.5 mm ² AWG 14	7.5 mm																													
wide groove	3 mm ² AWG 12	7.5 mm																													
no groove	4 mm ² AWG 12	7.5 mm																													
Han E®, Crimp contact, silver plated contacts, contact resistance ≤1 mOhm 	0.14–0.37 0.5 0.75 1 1.5 2.5 3 4	09 33 000 6127 09 33 000 6121 09 33 000 6114 09 33 000 6105 09 33 000 6104 09 33 000 6102 09 33 000 6106 09 33 000 6107	09 33 000 6227 09 33 000 6220 09 33 000 6214 09 33 000 6205 09 33 000 6204 09 33 000 6202 09 33 000 6206 09 33 000 6207	 <table border="1"> <thead> <tr> <th>Identification</th> <th>Wire gauge</th> <th>Stripping length</th> </tr> </thead> <tbody> <tr> <td>no groove</td> <td>0.14-0.37 mm² AWG 26-22</td> <td>7.5 mm</td> </tr> <tr> <td>no groove</td> <td>0.5 mm² AWG 20</td> <td>7.5 mm</td> </tr> <tr> <td>1 groove*</td> <td>0.75 mm² AWG 18</td> <td>7.5 mm</td> </tr> <tr> <td>1 groove</td> <td>1 mm² AWG 18</td> <td>7.5 mm</td> </tr> <tr> <td>2 grooves</td> <td>1.5 mm² AWG 16</td> <td>7.5 mm</td> </tr> <tr> <td>3 grooves</td> <td>2.5 mm² AWG 14</td> <td>7.5 mm</td> </tr> <tr> <td>wide groove</td> <td>3 mm² AWG 12</td> <td>7.5 mm</td> </tr> <tr> <td>no groove</td> <td>4 mm² AWG 12</td> <td>7.5 mm</td> </tr> </tbody> </table> <p>* on the back crimp collar</p>	Identification	Wire gauge	Stripping length	no groove	0.14-0.37 mm ² AWG 26-22	7.5 mm	no groove	0.5 mm ² AWG 20	7.5 mm	1 groove*	0.75 mm ² AWG 18	7.5 mm	1 groove	1 mm ² AWG 18	7.5 mm	2 grooves	1.5 mm ² AWG 16	7.5 mm	3 grooves	2.5 mm ² AWG 14	7.5 mm	wide groove	3 mm ² AWG 12	7.5 mm	no groove	4 mm ² AWG 12	7.5 mm
Identification	Wire gauge	Stripping length																													
no groove	0.14-0.37 mm ² AWG 26-22	7.5 mm																													
no groove	0.5 mm ² AWG 20	7.5 mm																													
1 groove*	0.75 mm ² AWG 18	7.5 mm																													
1 groove	1 mm ² AWG 18	7.5 mm																													
2 grooves	1.5 mm ² AWG 16	7.5 mm																													
3 grooves	2.5 mm ² AWG 14	7.5 mm																													
wide groove	3 mm ² AWG 12	7.5 mm																													
no groove	4 mm ² AWG 12	7.5 mm																													

Features

- Reliable cage clamp termination
- No special tools required

Derating

Current carrying capacity

The current carrying capacity of the connectors is limited by the thermal load capability of the contact element material including the connections and the insulating parts. The derating curve is therefore valid for currents which flow constantly (non-intermittent) through each contact element of the connector evenly, without exceeding the allowed maximum temperature.

Measuring and testing techniques acc. to IEC 60512-5-2

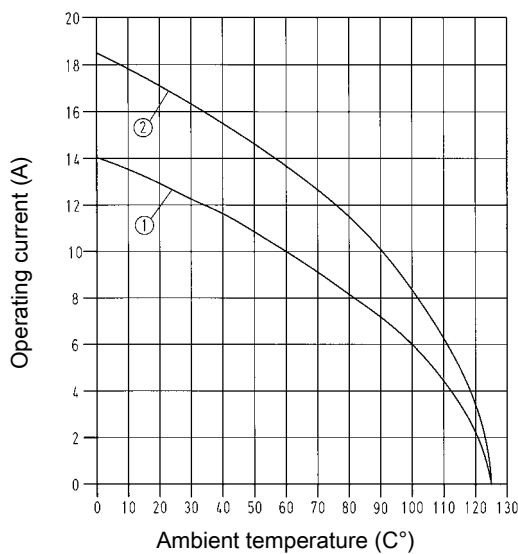

- ① 24 B hoods/housings with 6 modules Wire cross section 1.5 mm²
- ② 24 B hoods/housings with 6 modules Wire cross section 2.5 mm²

Technical characteristics

Contacts	5
Electrical data acc. to IEC 61984	16 A 400 V 6 kV 3
Rated current	16 A
Rated voltage	400 V
Rated impulse voltage	6 kV
Pollution degree	3
Rated voltage acc. to UL	600 V
Insulation resistance	≥10 ¹⁰ Ohm
Limiting temperatures	-40 °C ... 125 °C
Flammability (insert) acc. to UL 94	V 0
Mating cycles	≥500
Material (insert)	polycarbonate
Colour (insert)	RAL 7032 (light grey)
Material (contact)	copper alloy

Specifications and approvals

IEC 60664-1
IEC 61984



Number of contacts

5

400 V
16 A

Han-Modular

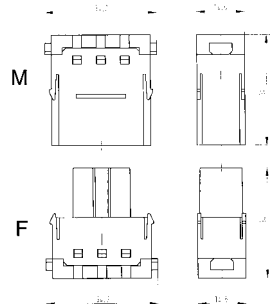
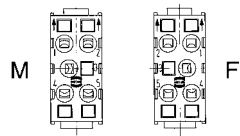
Identification	Wire cross section (mm ²)	Part number		Drawing Dimensions in mm
		male	female	
Han-Modular®, Han® ES module, Cage-clamp terminal, silver plated contacts, contact resistance ≤3 mOhm 	0.14 – 2.5	09 14 005 2616	09 14 005 2716	
Han-Modular®, Han® ES module, Cage-clamp terminal, gold plated contacts, contact resistance ≤3 mOhm	0.14 – 2.5	09 14 005 2617	09 14 005 2717	 Contact arrangement (view from termination side)

Features

- Available in two versions: for Han® C or Han E® crimp contacts
- 2 contacts up to 5000 V
- Insulator out of a voltage resistant teflon material
- Combination of all other modules (pneumatic, signal etc.)

Derating

Current carrying capacity

The current carrying capacity of the connectors is limited by the thermal load capability of the contact element material including the connections and the insulating parts. The derating curve is therefore valid for currents which flow constantly (non-intermittent) through each contact element of the connector evenly, without exceeding the allowed maximum temperature.

Measuring and testing techniques acc. to IEC 60512-5-2

Han® C Crimp contacts

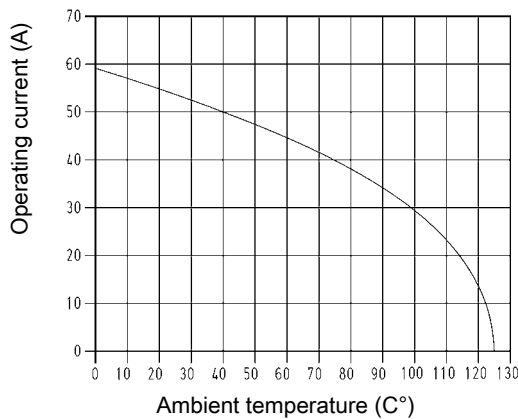

① 24 B hoods/housings with 3 modules Wire cross section 6 mm²

Han E® crimp contacts

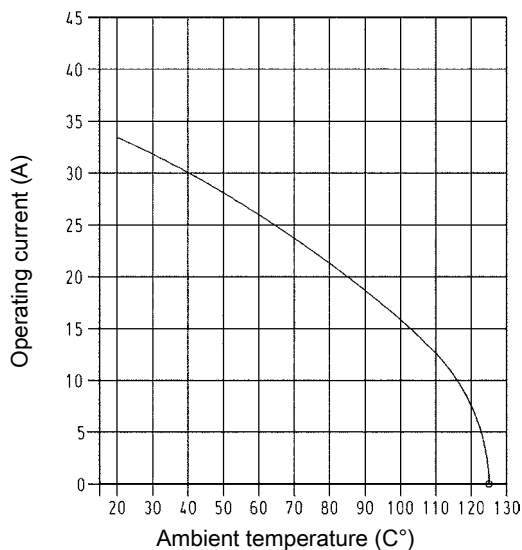

① Housing Han® 16 B with 1 Han® HV module Wire cross section 2.5 mm²

Technical characteristics

Contacts	2
Electrical data acc. to IEC 61984	40 A 2900/5000 V 15 kV 3 16 A 2900/5000 V 15 kV 3
Rated current	40 A, 16 A
Rated voltage conductor - ground	2900 V
Rated voltage conductor - conductor	5000 V
Rated impulse voltage	15 kV
Pollution degree	3
Insulation resistance	≥10 ¹⁰ Ohm
Limiting temperatures	-40 °C ... 125 °C
Flammability (insert) acc. to UL 94	V 0
Mating cycles	≥500
Material (insert)	polycarbonate/Teflon (PTFE)
Colour (insert)	RAL 7032 (light grey)
Material (contact)	copper alloy

Specifications and approvals

IEC 61984
IEC 60664-1
IEC 60352-4



Details

Crimping tools see chapter 90

Remarks on the crimp technique



The wire gauges mentioned in the catalogue refer to geometric wire gauges of cables.

Number of contacts

2

2900/5000 V
40 A

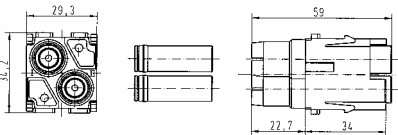
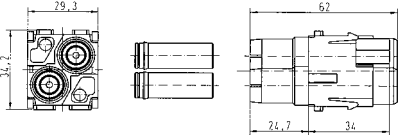
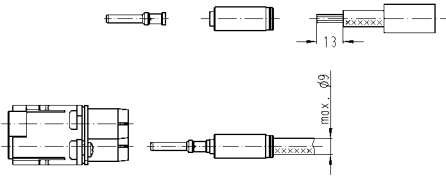
Han-Modular

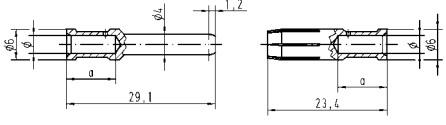
Identification	Wire cross section (mm ²)	Part number		Drawing Dimensions in mm																		
		male	female																			
<p>Han-Modular®, Han® HV module, for Han® C crimp contacts, Crimp terminal ... 9 mm</p> <p>Range of delivery: 1 module, 2 locking sleeves, 2 heat shrink tubes</p>  <p>Please order crimp contacts separately.</p>		09 14 002 3023	09 14 002 3123	<p>M</p>  <p>F</p>  <p>Assembly instructions</p>  <p>Crimp with tool 09 99 000 0888, 09 99 000 0110 or 09 99 000 0377. Snap crimped cable in the insert. Shrink the heat shrink tube over the rear of contact.</p>																		
<p>Han® C, Crimp contact, silver plated contacts, contact resistance ≤1 mOhm</p> 	1.5 2.5 4 6 10	09 32 000 6104 09 32 000 6105 09 32 000 6107 09 32 000 6108 09 32 000 6109	09 32 000 6204 09 32 000 6205 09 32 000 6207 09 32 000 6208 09 32 000 6209	 <table border="1"> <thead> <tr> <th>Wire gauge</th> <th>Ø</th> <th>Stripping length</th> </tr> </thead> <tbody> <tr> <td>1.5 mm² AWG 16</td> <td>1.75</td> <td>9.5 mm</td> </tr> <tr> <td>2.5 mm² AWG 14</td> <td>2.25</td> <td>9.5 mm</td> </tr> <tr> <td>4 mm² AWG 12</td> <td>2.85</td> <td>9.5 mm</td> </tr> <tr> <td>6 mm² AWG 10</td> <td>3.5</td> <td>9.5 mm</td> </tr> <tr> <td>10 mm² AWG 8</td> <td>4.3</td> <td>12 mm</td> </tr> </tbody> </table>	Wire gauge	Ø	Stripping length	1.5 mm ² AWG 16	1.75	9.5 mm	2.5 mm ² AWG 14	2.25	9.5 mm	4 mm ² AWG 12	2.85	9.5 mm	6 mm ² AWG 10	3.5	9.5 mm	10 mm ² AWG 8	4.3	12 mm
Wire gauge	Ø	Stripping length																				
1.5 mm ² AWG 16	1.75	9.5 mm																				
2.5 mm ² AWG 14	2.25	9.5 mm																				
4 mm ² AWG 12	2.85	9.5 mm																				
6 mm ² AWG 10	3.5	9.5 mm																				
10 mm ² AWG 8	4.3	12 mm																				

Number of contacts

2

2900/5000 V
16 A

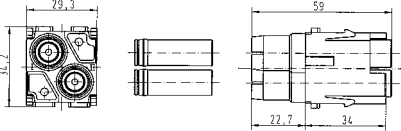
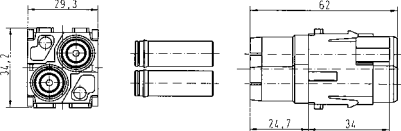
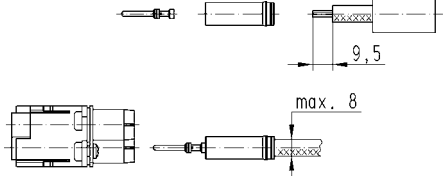
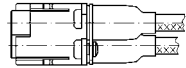
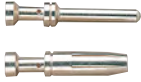
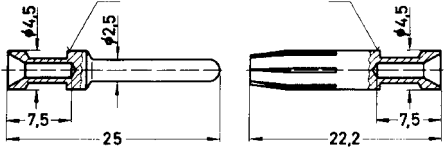
Identification	Wire cross section (mm²)	Part number		Drawing Dimensions in mm																																			
		male	female																																				
<p>Han-Modular®, Han® HV module, for Han E® crimp contacts, Crimp terminal</p> <p>Range of delivery: 1 module, 2 locking sleeves, 2 heat shrink tubes</p>  <p>Please order crimp contacts separately.</p>		09 14 002 3021	09 14 002 3121	<p>M</p>  <p>F</p>  <p>Assembly instructions</p>   <p>Crimp with crimping tool 09 99 000 0888 Snap crimped cable in the insert. Shrink the heat shrink tube over the rear of contact.</p>																																			
<p>Han E®, Crimp contact, silver plated contacts, contact resistance ≤1 mOhm</p> 	<p>0.5 0.75 1 1.5 2.5 3 4</p>	<p>09 33 000 6121 09 33 000 6114 09 33 000 6105 09 33 000 6104 09 33 000 6102 09 33 000 6106 09 33 000 6107</p>	<p>09 33 000 6220 09 33 000 6214 09 33 000 6205 09 33 000 6204 09 33 000 6202 09 33 000 6206 09 33 000 6207</p>	 <table border="1"> <thead> <tr> <th>Identification</th> <th>Wire gauge</th> <th>Stripping length</th> </tr> </thead> <tbody> <tr> <td>no groove</td> <td>0.14-0.37 mm²</td> <td>AWG 26-22</td> <td>7.5 mm</td> </tr> <tr> <td>no groove</td> <td>0.5 mm²</td> <td>AWG 20</td> <td>7.5 mm</td> </tr> <tr> <td>1 groove*</td> <td>0.75 mm²</td> <td>AWG 18</td> <td>7.5 mm</td> </tr> <tr> <td>1 groove</td> <td>1 mm²</td> <td>AWG 18</td> <td>7.5 mm</td> </tr> <tr> <td>2 grooves</td> <td>1.5 mm²</td> <td>AWG 16</td> <td>7.5 mm</td> </tr> <tr> <td>3 grooves</td> <td>2.5 mm²</td> <td>AWG 14</td> <td>7.5 mm</td> </tr> <tr> <td>wide groove</td> <td>3 mm²</td> <td>AWG 12</td> <td>7.5 mm</td> </tr> <tr> <td>no groove</td> <td>4 mm²</td> <td>AWG 12</td> <td>7.5 mm</td> </tr> </tbody> </table> <p>* on the back crimp collar</p>	Identification	Wire gauge	Stripping length	no groove	0.14-0.37 mm²	AWG 26-22	7.5 mm	no groove	0.5 mm²	AWG 20	7.5 mm	1 groove*	0.75 mm²	AWG 18	7.5 mm	1 groove	1 mm²	AWG 18	7.5 mm	2 grooves	1.5 mm²	AWG 16	7.5 mm	3 grooves	2.5 mm²	AWG 14	7.5 mm	wide groove	3 mm²	AWG 12	7.5 mm	no groove	4 mm²	AWG 12	7.5 mm
Identification	Wire gauge	Stripping length																																					
no groove	0.14-0.37 mm²	AWG 26-22	7.5 mm																																				
no groove	0.5 mm²	AWG 20	7.5 mm																																				
1 groove*	0.75 mm²	AWG 18	7.5 mm																																				
1 groove	1 mm²	AWG 18	7.5 mm																																				
2 grooves	1.5 mm²	AWG 16	7.5 mm																																				
3 grooves	2.5 mm²	AWG 14	7.5 mm																																				
wide groove	3 mm²	AWG 12	7.5 mm																																				
no groove	4 mm²	AWG 12	7.5 mm																																				

Features

- Suitable for Han E® crimp contacts
- 2 contacts up to 2500 V
- Insulator out of a voltage resistant teflon material
- Combination of all other modules (pneumatic, signal etc.)

Derating

Current carrying capacity

The current carrying capacity of the connectors is limited by the thermal load capability of the contact element material including the connections and the insulating parts. The derating curve is therefore valid for currents which flow constantly (non-intermittent) through each contact element of the connector evenly, without exceeding the allowed maximum temperature.

Measuring and testing techniques acc. to IEC 60512-5-2

Han E® crimp contacts

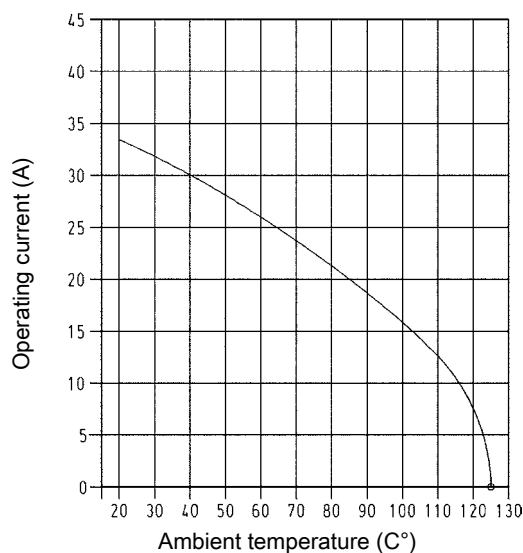

① Housing Han® 16 B with 1 Han® HV module Wire cross section 2.5 mm²

Technical characteristics

Contacts	2
Electrical data acc. to IEC 61984	16 A 2500 V 15 kV 3
Rated current	16 A
Rated voltage	2500 V
Rated impulse voltage	15 kV
Pollution degree	3
Insulation resistance	≥10 ¹⁰ Ohm
Limiting temperatures	-40 °C ... 125 °C
Flammability (insert) acc. to UL 94	V 0
Mating cycles	≥500
Material (insert)	polycarbonate/Teflon (PTFE)
Colour (insert)	RAL 7032 (light grey)
Material (contact)	copper alloy

Specifications and approvals

IEC 60664-1
IEC 61984



Details

Crimping tools see chapter 90

Remarks on the crimp technique

The wire gauges mentioned in the catalogue refer to geometric wire gauges of cables.

Number of contacts

2

2500 V
16 A

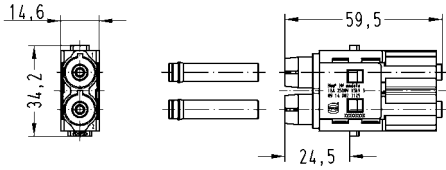
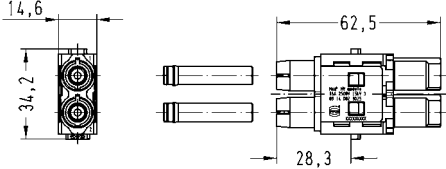
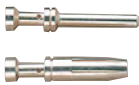
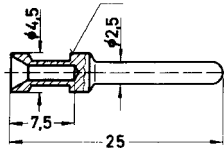
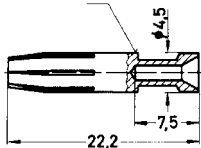
Identification	Wire cross section (mm²)	Part number		Drawing Dimensions in mm																											
		male	female																												
Han-Modular®, Han® HV module, Crimp terminal Range of delivery: 1 module, 2 locking sleeves, 2 heat shrink tubes  Please order crimp contacts separately.		09 14 002 3025	09 14 002 3125	 																											
Han E®, Crimp contact, silver plated contacts, contact resistance ≤1 mOhm 	0.5 0.75 1 1.5 2.5 3 4	09 33 000 6121 09 33 000 6114 09 33 000 6105 09 33 000 6104 09 33 000 6102 09 33 000 6106 09 33 000 6107	09 33 000 6220 09 33 000 6214 09 33 000 6205 09 33 000 6204 09 33 000 6202 09 33 000 6206 09 33 000 6207	  <table border="1"> <thead> <tr> <th>Identification</th> <th>Wire gauge</th> <th>Stripping length</th> </tr> </thead> <tbody> <tr> <td>no groove</td> <td>0.14-0.37 mm² AWG 26-22</td> <td>7.5 mm</td> </tr> <tr> <td>no groove</td> <td>0.5 mm² AWG 20</td> <td>7.5 mm</td> </tr> <tr> <td>1 groove*</td> <td>0.75 mm² AWG 18</td> <td>7.5 mm</td> </tr> <tr> <td>1 groove</td> <td>1 mm² AWG 18</td> <td>7.5 mm</td> </tr> <tr> <td>2 grooves</td> <td>1.5 mm² AWG 16</td> <td>7.5 mm</td> </tr> <tr> <td>3 grooves</td> <td>2.5 mm² AWG 14</td> <td>7.5 mm</td> </tr> <tr> <td>wide groove</td> <td>3 mm² AWG 12</td> <td>7.5 mm</td> </tr> <tr> <td>no groove</td> <td>4 mm² AWG 12</td> <td>7.5 mm</td> </tr> </tbody> </table> <p>* on the back crimp collar</p>	Identification	Wire gauge	Stripping length	no groove	0.14-0.37 mm² AWG 26-22	7.5 mm	no groove	0.5 mm² AWG 20	7.5 mm	1 groove*	0.75 mm² AWG 18	7.5 mm	1 groove	1 mm² AWG 18	7.5 mm	2 grooves	1.5 mm² AWG 16	7.5 mm	3 grooves	2.5 mm² AWG 14	7.5 mm	wide groove	3 mm² AWG 12	7.5 mm	no groove	4 mm² AWG 12	7.5 mm
Identification	Wire gauge	Stripping length																													
no groove	0.14-0.37 mm² AWG 26-22	7.5 mm																													
no groove	0.5 mm² AWG 20	7.5 mm																													
1 groove*	0.75 mm² AWG 18	7.5 mm																													
1 groove	1 mm² AWG 18	7.5 mm																													
2 grooves	1.5 mm² AWG 16	7.5 mm																													
3 grooves	2.5 mm² AWG 14	7.5 mm																													
wide groove	3 mm² AWG 12	7.5 mm																													
no groove	4 mm² AWG 12	7.5 mm																													

Han-Modular

Features

- Han-Quick Lock[®] or Crimp terminal available
- Standard module for signal up to 10 A

Derating

Current carrying capacity

The current carrying capacity of the connectors is limited by the thermal load capability of the contact element material including the connections and the insulating parts. The derating curve is therefore valid for currents which flow constantly (non-intermittent) through each contact element of the connector evenly, without exceeding the allowed maximum temperature.

Measuring and testing techniques acc. to IEC 60512-5-2

Quick Lock termination

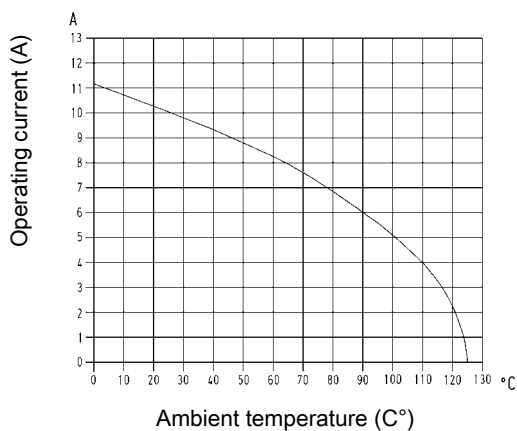

① 24 B hoods/housings with 6 modules Wire cross section 1.5 mm²

Crimp terminal

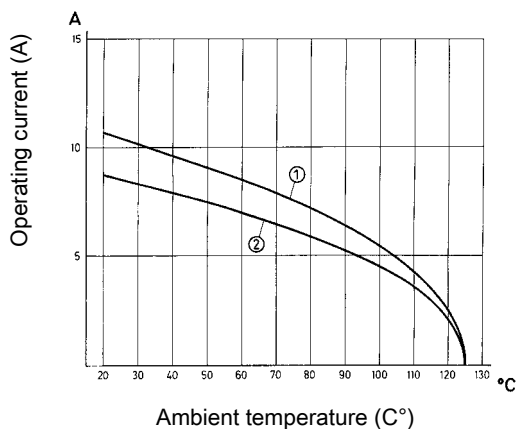

① 24 B hoods/housings with 6 modules Wire cross section 1.5 mm²

② 24 B hoods/housings with 6 modules Wire cross section 1 mm²

Technical characteristics

Contacts	12
Electrical data acc. to IEC 61984	black slide 10 A 250 V 4 kV 3 10 A 250 V 4 kV 3
Rated current	10 A
Rated voltage	250 V
Rated impulse voltage	4 kV
Pollution degree	3
Rated voltage acc. to UL	600 V
Insulation resistance	≥10 ¹⁰ Ohm
Limiting temperatures	-40 °C ... 125 °C
Flammability (insert) acc. to UL 94	V 0
Mating cycles	≥500
Mating cycles with HMC contacts	≥10000
Material (insert)	polycarbonate
Colour (insert)	RAL 7032 (light grey)
Material (contact)	copper alloy

Specifications and approvals

IEC 60664-1
IEC 61984



Details

Crimping tools see chapter 90

Remarks on the crimp technique

The wire gauges mentioned in the catalogue refer to geometric wire gauges of cables.

Designed for 10,000 mating cycles (only with Han D[®] HMC crimp contacts and with Han-Modular[®] Docking frame)

Number of contacts



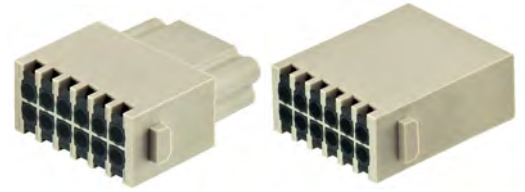

12+

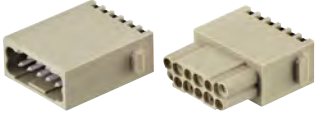
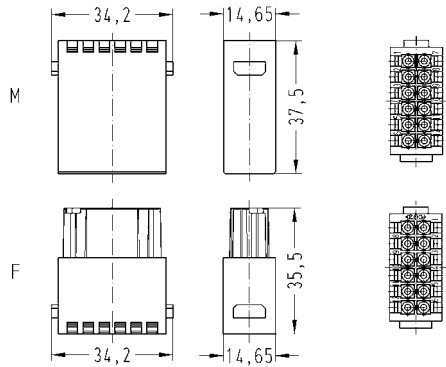
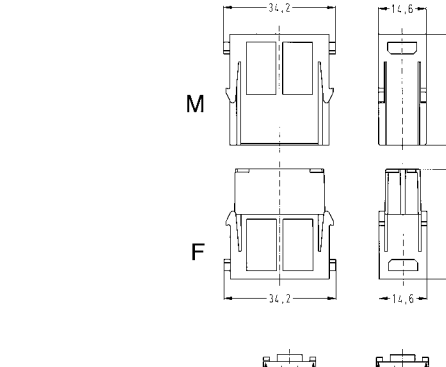
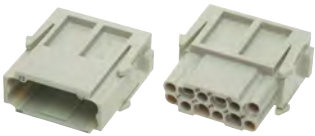
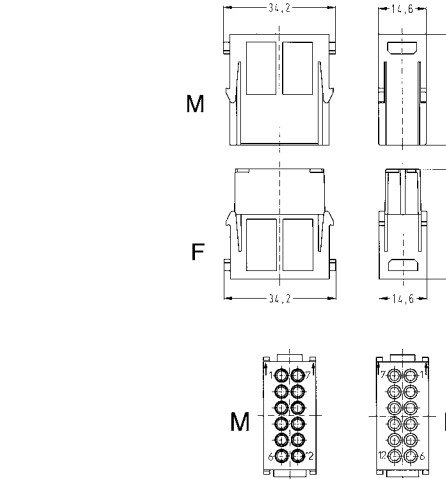
250 V
10 A

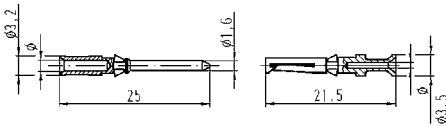

Identification	Wire cross section (mm ²)	Part number male female		Drawing Dimensions in mm
<p> Han-Quick Lock[®] Han-Modular[®], Han DD[®] module, Han-Quick Lock[®] termination, black slide, silver plated contacts, contact resistance ≤3 mOhm</p> 	0.25 – 1.5	09 14 012 2632	09 14 012 2732	 <p>34,2 14,65 37,5 34,2 14,65 35,5</p> <p>M F</p> <p>Contact arrangement (view from termination side)</p>
<p> Han-Quick Lock[®] Han-Modular[®], Han DD[®] module, Han-Quick Lock[®] termination, black slide, gold plated contacts, contact resistance ≤3 mOhm</p>	0.25 – 1.5	09 14 012 2634	09 14 012 2734	 <p>34,2 14,65 34 34,2 14,65 34</p> <p>M F</p> <p>Contact arrangement (view from termination side)</p>
<p>Han-Modular[®], Han DD[®] module, Crimp terminal</p>  <p>Please order crimp contacts separately.</p>		09 14 012 3001	09 14 012 3101	 <p>34,2 14,6 34 34,2 14,6 34</p> <p>M F</p> <p>Contact arrangement (view from termination side)</p>

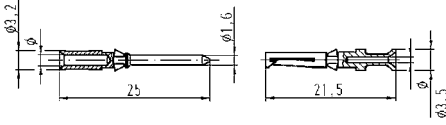
Han-Modular

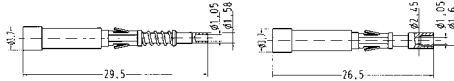
Identification	Wire cross section (mm ²)	Part number		Drawing Dimensions in mm																					
		male	female																						
Han D®, Crimp contact, gold plated contacts, contact resistance ≤3 mOhm 	0.14–0.37	09 15 000 6124	09 15 000 6224	 <table border="1" data-bbox="1008 499 1465 658"> <thead> <tr> <th>Wire gauge</th> <th>∅</th> <th>Stripping length</th> </tr> </thead> <tbody> <tr> <td>0.14-0.37 mm² AWG 26-22</td> <td>0.9 mm</td> <td>8 mm</td> </tr> <tr> <td>0.5 mm² AWG 20</td> <td>1.1 mm</td> <td>8 mm</td> </tr> <tr> <td>0.75 mm² AWG 18</td> <td>1.3 mm</td> <td>8 mm</td> </tr> <tr> <td>1 mm² AWG 18</td> <td>1.45 mm</td> <td>8 mm</td> </tr> <tr> <td>1.5 mm² AWG 16</td> <td>1.75 mm</td> <td>8 mm</td> </tr> <tr> <td>2.5 mm² AWG 14</td> <td>2.25 mm</td> <td>6 mm</td> </tr> </tbody> </table>	Wire gauge	∅	Stripping length	0.14-0.37 mm ² AWG 26-22	0.9 mm	8 mm	0.5 mm ² AWG 20	1.1 mm	8 mm	0.75 mm ² AWG 18	1.3 mm	8 mm	1 mm ² AWG 18	1.45 mm	8 mm	1.5 mm ² AWG 16	1.75 mm	8 mm	2.5 mm ² AWG 14	2.25 mm	6 mm
	Wire gauge	∅	Stripping length																						
	0.14-0.37 mm ² AWG 26-22	0.9 mm	8 mm																						
	0.5 mm ² AWG 20	1.1 mm	8 mm																						
	0.75 mm ² AWG 18	1.3 mm	8 mm																						
	1 mm ² AWG 18	1.45 mm	8 mm																						
1.5 mm ² AWG 16	1.75 mm	8 mm																							
2.5 mm ² AWG 14	2.25 mm	6 mm																							
0.5	09 15 000 6123	09 15 000 6223																							
0.75	09 15 000 6125	09 15 000 6225																							
1	09 15 000 6122	09 15 000 6222																							
1.5	09 15 000 6121	09 15 000 6221																							
2.5	09 15 000 6126	09 15 000 6226																							
Han D®, Crimp contact, silver plated contacts, contact resistance ≤3 mOhm 	0.14–0.37	09 15 000 6104	09 15 000 6204	 <table border="1" data-bbox="1008 862 1465 1021"> <thead> <tr> <th>Wire gauge</th> <th>∅</th> <th>Stripping length</th> </tr> </thead> <tbody> <tr> <td>0.14-0.37 mm² AWG 26-22</td> <td>0.9 mm</td> <td>8 mm</td> </tr> <tr> <td>0.5 mm² AWG 20</td> <td>1.1 mm</td> <td>8 mm</td> </tr> <tr> <td>0.75 mm² AWG 18</td> <td>1.3 mm</td> <td>8 mm</td> </tr> <tr> <td>1 mm² AWG 18</td> <td>1.45 mm</td> <td>8 mm</td> </tr> <tr> <td>1.5 mm² AWG 16</td> <td>1.75 mm</td> <td>8 mm</td> </tr> <tr> <td>2.5 mm² AWG 14</td> <td>2.25 mm</td> <td>6 mm</td> </tr> </tbody> </table>	Wire gauge	∅	Stripping length	0.14-0.37 mm ² AWG 26-22	0.9 mm	8 mm	0.5 mm ² AWG 20	1.1 mm	8 mm	0.75 mm ² AWG 18	1.3 mm	8 mm	1 mm ² AWG 18	1.45 mm	8 mm	1.5 mm ² AWG 16	1.75 mm	8 mm	2.5 mm ² AWG 14	2.25 mm	6 mm
	Wire gauge	∅	Stripping length																						
	0.14-0.37 mm ² AWG 26-22	0.9 mm	8 mm																						
	0.5 mm ² AWG 20	1.1 mm	8 mm																						
	0.75 mm ² AWG 18	1.3 mm	8 mm																						
	1 mm ² AWG 18	1.45 mm	8 mm																						
1.5 mm ² AWG 16	1.75 mm	8 mm																							
2.5 mm ² AWG 14	2.25 mm	6 mm																							
0.5	09 15 000 6103	09 15 000 6203																							
0.75	09 15 000 6105	09 15 000 6205																							
1	09 15 000 6102	09 15 000 6202																							
1.5	09 15 000 6101	09 15 000 6201																							
2.5	09 15 000 6106	09 15 000 6206																							
F.O. contact  for 1 mm plastic fibre		20 10 001 3211	20 10 001 3221	 <p>20 10 001 3211 + 20 10 001 3221</p>																					

Features

- Suitable for Han D[®] crimp contacts
- High contact density

Derating

Current carrying capacity

The current carrying capacity of the connectors is limited by the thermal load capability of the contact element material including the connections and the insulating parts. The derating curve is therefore valid for currents which flow constantly (non-intermittent) through each contact element of the connector evenly, without exceeding the allowed maximum temperature.

Measuring and testing techniques acc. to IEC 60512-5-2

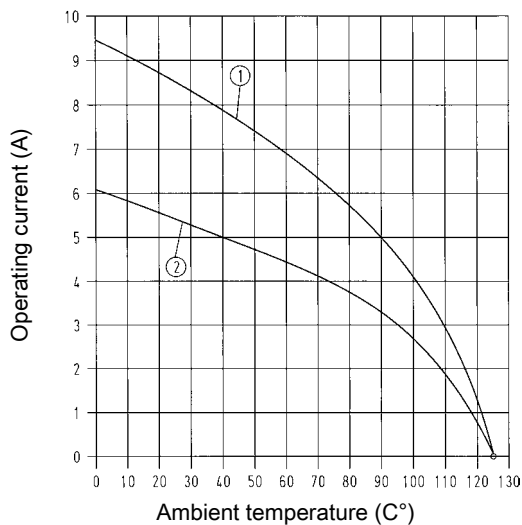

- ① 24 B hoods/housings with 6 modules Wire cross section 1.5 mm²
- ② 24 B hoods/housings with 6 modules Wire cross section 1 mm²

Technical characteristics

Contacts	17
Electrical data acc. to IEC 61984	10 A 160 V 2.5 kV 3
Rated current	10 A
Rated voltage	160 V
Rated impulse voltage	2.5 kV
Pollution degree	3
Rated voltage acc. to UL	250 V
Insulation resistance	≥10 ¹⁰ Ohm
Limiting temperatures	-40 °C ... 125 °C
Flammability (insert) acc. to UL 94	V 0
Mating cycles	≥500
Mating cycles with HMC contacts	≥10000
Material (insert)	polycarbonate
Colour (insert)	RAL 7032 (light grey)
Material (contact)	copper alloy

Specifications and approvals

IEC 60664-1
IEC 61984



Details

Crimping tools see chapter 90

Remarks on the crimp technique

The wire gauges mentioned in the catalogue refer to geometric wire gauges of cables.







Designed for 10,000 mating cycles (only with Han D[®] HMC crimp contacts and with Han-Modular[®] Docking frame)

Number of contacts

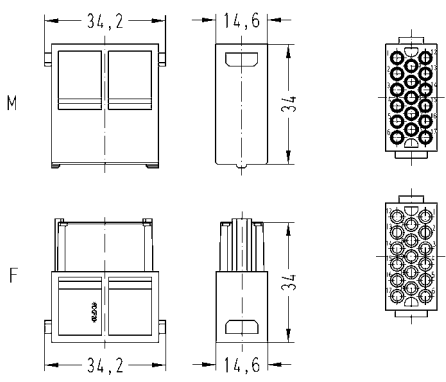
17

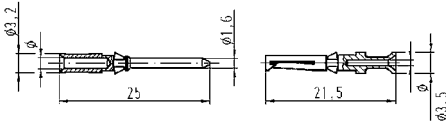
160 V
10 A

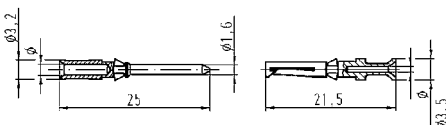
Han-Modular

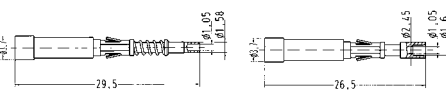
Identification	Wire cross section (mm ²)	Part number		Drawing Dimensions in mm																					
		male	female																						
Han-Modular®, Han® DDD module, Crimp terminal  Please order crimp contacts separately.		09 14 017 3001	09 14 017 3101	 Contact arrangement (view from termination side)																					
Han D®, Crimp contact, gold plated contacts, contact resistance ≤3 mOhm 	0.14 – 0.37 0.5 0.75 1 1.5 2.5	09 15 000 6124 09 15 000 6123 09 15 000 6125 09 15 000 6122 09 15 000 6121 09 15 000 6126	09 15 000 6224 09 15 000 6223 09 15 000 6225 09 15 000 6222 09 15 000 6221 09 15 000 6226	 <table border="1"> <thead> <tr> <th>Wire gauge</th> <th>∅</th> <th>Stripping length</th> </tr> </thead> <tbody> <tr> <td>0.14-0.37 mm² AWG 26-22</td> <td>0.9 mm</td> <td>8 mm</td> </tr> <tr> <td>0.5 mm² AWG 20</td> <td>1.1 mm</td> <td>8 mm</td> </tr> <tr> <td>0.75 mm² AWG 18</td> <td>1.3 mm</td> <td>8 mm</td> </tr> <tr> <td>1 mm² AWG 18</td> <td>1.45 mm</td> <td>8 mm</td> </tr> <tr> <td>1.5 mm² AWG 16</td> <td>1.75 mm</td> <td>8 mm</td> </tr> <tr> <td>2.5 mm² AWG 14</td> <td>2.25 mm</td> <td>6 mm</td> </tr> </tbody> </table>	Wire gauge	∅	Stripping length	0.14-0.37 mm ² AWG 26-22	0.9 mm	8 mm	0.5 mm ² AWG 20	1.1 mm	8 mm	0.75 mm ² AWG 18	1.3 mm	8 mm	1 mm ² AWG 18	1.45 mm	8 mm	1.5 mm ² AWG 16	1.75 mm	8 mm	2.5 mm ² AWG 14	2.25 mm	6 mm
Wire gauge	∅	Stripping length																							
0.14-0.37 mm ² AWG 26-22	0.9 mm	8 mm																							
0.5 mm ² AWG 20	1.1 mm	8 mm																							
0.75 mm ² AWG 18	1.3 mm	8 mm																							
1 mm ² AWG 18	1.45 mm	8 mm																							
1.5 mm ² AWG 16	1.75 mm	8 mm																							
2.5 mm ² AWG 14	2.25 mm	6 mm																							
Han D®, Crimp contact, silver plated contacts, contact resistance ≤3 mOhm 	0.14 – 0.37 0.5 0.75 1 1.5 2.5	09 15 000 6104 09 15 000 6103 09 15 000 6105 09 15 000 6102 09 15 000 6101 09 15 000 6106	09 15 000 6204 09 15 000 6203 09 15 000 6205 09 15 000 6202 09 15 000 6201 09 15 000 6206	 <table border="1"> <thead> <tr> <th>Wire gauge</th> <th>∅</th> <th>Stripping length</th> </tr> </thead> <tbody> <tr> <td>0.14-0.37 mm² AWG 26-22</td> <td>0.9 mm</td> <td>8 mm</td> </tr> <tr> <td>0.5 mm² AWG 20</td> <td>1.1 mm</td> <td>8 mm</td> </tr> <tr> <td>0.75 mm² AWG 18</td> <td>1.3 mm</td> <td>8 mm</td> </tr> <tr> <td>1 mm² AWG 18</td> <td>1.45 mm</td> <td>8 mm</td> </tr> <tr> <td>1.5 mm² AWG 16</td> <td>1.75 mm</td> <td>8 mm</td> </tr> <tr> <td>2.5 mm² AWG 14</td> <td>2.25 mm</td> <td>6 mm</td> </tr> </tbody> </table>	Wire gauge	∅	Stripping length	0.14-0.37 mm ² AWG 26-22	0.9 mm	8 mm	0.5 mm ² AWG 20	1.1 mm	8 mm	0.75 mm ² AWG 18	1.3 mm	8 mm	1 mm ² AWG 18	1.45 mm	8 mm	1.5 mm ² AWG 16	1.75 mm	8 mm	2.5 mm ² AWG 14	2.25 mm	6 mm
Wire gauge	∅	Stripping length																							
0.14-0.37 mm ² AWG 26-22	0.9 mm	8 mm																							
0.5 mm ² AWG 20	1.1 mm	8 mm																							
0.75 mm ² AWG 18	1.3 mm	8 mm																							
1 mm ² AWG 18	1.45 mm	8 mm																							
1.5 mm ² AWG 16	1.75 mm	8 mm																							
2.5 mm ² AWG 14	2.25 mm	6 mm																							
F.O. contact  for 1 mm plastic fibre		20 10 001 3211	20 10 001 3221	 20 10 001 3211 + 20 10 001 3221																					

Features

- Suitable for D-Sub crimp contacts
- High contact density

Derating

Current carrying capacity

The current carrying capacity of the connectors is limited by the thermal load capability of the contact element material including the connections and the insulating parts. The derating curve is therefore valid for currents which flow constantly (non-intermittent) through each contact element of the connector evenly, without exceeding the allowed maximum temperature.

Measuring and testing techniques acc. to IEC 60512-5-2

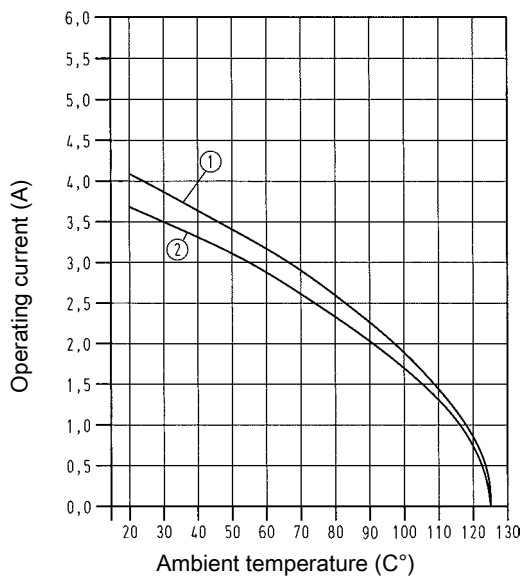

- ① 24 B hoods/housings with 6 modules; turned contacts Wire cross section 0.5 mm²
 ② 24 B hoods/housings with 6 modules; stamped contacts Wire cross section 0.5 mm²

Technical characteristics

Contacts	25
Electrical data acc. to IEC 61984	4 A 50 V 0.8 kV 3
Rated current	4 A
Rated voltage	50 V
Rated impulse voltage	0.8 kV
Pollution degree	3
Rated voltage acc. to UL	30 V
Insulation resistance	≥10 ¹⁰ Ohm
Limiting temperatures	-40 °C ... 125 °C
Flammability (insert) acc. to UL 94	V 0
Mating cycles	≥500
Material (insert)	polycarbonate
Colour (insert)	RAL 7032 (light grey)

Specifications and approvals

IEC 60664-1
IEC 61984



Details



Guide pins and bushes are recommended (see chapter 80).

Number of contacts

25

50 V
4 A

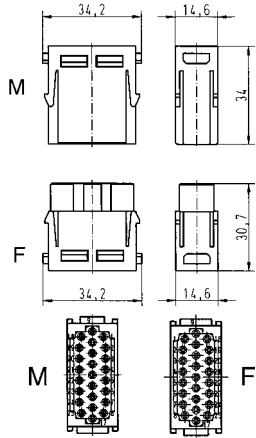
Han-
Modular

Identification	Wire cross section (mm²)	Part number		Drawing Dimensions in mm												
		male	female													
Han-Modular®, Han® High Density module, Crimp terminal  Please order crimp contacts separately.		09 14 025 3001	09 14 025 3101	 Contact arrangement (view from termination side)												
Han® D-Sub crimp contact, turned contacts 	0.09–0.25 0.13–0.33 0.25–0.52	09 67 000 7576 09 67 000 5576 09 67 000 8576	09 67 000 7476 09 67 000 5476 09 67 000 8476	<table border="1"> <thead> <tr> <th>Wire gauge</th> <th>max. insulation diameter</th> <th>Stripping length</th> </tr> </thead> <tbody> <tr> <td>0.09-0.25 mm²</td> <td>1.7</td> <td>4 mm</td> </tr> <tr> <td>0.13-0.33 mm²</td> <td>1.7</td> <td>4 mm</td> </tr> <tr> <td>0.25-0.52 mm²</td> <td>1.7</td> <td>4 mm</td> </tr> </tbody> </table>	Wire gauge	max. insulation diameter	Stripping length	0.09-0.25 mm²	1.7	4 mm	0.13-0.33 mm²	1.7	4 mm	0.25-0.52 mm²	1.7	4 mm
Wire gauge	max. insulation diameter	Stripping length														
0.09-0.25 mm²	1.7	4 mm														
0.13-0.33 mm²	1.7	4 mm														
0.25-0.52 mm²	1.7	4 mm														

Features

- 9-pin D-Sub connector of the Han-Modular® system
- Suitable for the transmission of sensitive signals
- Compatible to crimp, solder or IDC termination

Technical characteristics

Contacts	9
Electrical data acc. to IEC 61984	5 A 50 V 0.8 kV 3
Rated current	5 A
Rated voltage	50 V
Rated impulse voltage	0.8 kV
Pollution degree	3
Rated voltage acc. to UL	30 V
Insulation resistance	≥10 ¹⁰ Ohm
Limiting temperatures	-40 °C ... 125 °C
Flammability (insert) acc. to UL 94	V 0
Mating cycles	≥500
Material (insert)	polycarbonate
Colour (insert)	RAL 7032 (light grey)
Material (shielding element)	zinc die-cast alloy

Specifications and approvals

IEC 60664-1
IEC 61984



Details





Guide pins and bushes are recommended (see chapter 80).

Number of contacts

9

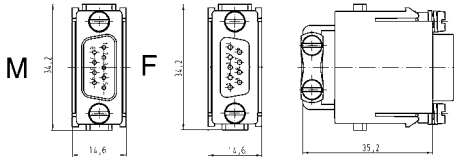
50 V
5 A

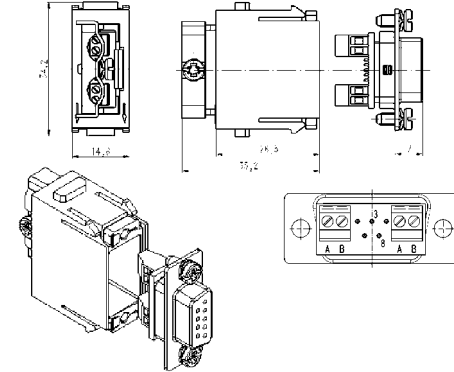
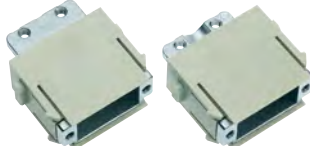
Han-Modular

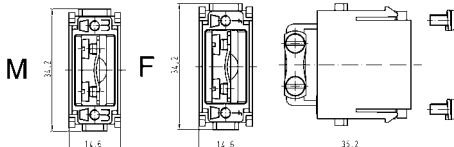
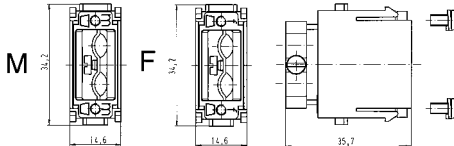
Identification	Wire cross section (mm²)	Part number		Drawing Dimensions in mm
		male	female	
Han-Modular®, Han® D-Sub module, Crimp terminal  Please order crimp contacts separately.		09 14 009 3001	09 14 009 3101	
Han-Modular®, Han® D-Sub module, for RS 485-based bus systems with T-functionality, Screw terminal 	0.08–0.52		09 14 009 3151	 Contact arrangement (view from termination side) Signal A: Contact no. 8 Signal B: Contact no. 3
Han-Modular®, Adapter module, for one cabel, for 9-pin D-Sub  Han-Modular®, Adapter module, for two cabels, for 9-pin D-Sub 		09 14 000 9930	09 14 000 9931	
		09 14 000 9932	09 14 000 9933	

Identification	Wire cross section (mm ²)	Part number		Drawing Dimensions in mm												
		male	female													
Han® D-Sub crimp contact, turned contacts 	0.09 – 0.25	09 67 000 7576	09 67 000 7476	<table border="1"> <thead> <tr> <th>Wire gauge</th> <th>max. insulation diameter</th> <th>Stripping length</th> </tr> </thead> <tbody> <tr> <td>0.09-0.25 mm²</td> <td>1.7</td> <td>4 mm</td> </tr> <tr> <td>0.13-0.33 mm²</td> <td>1.7</td> <td>4 mm</td> </tr> <tr> <td>0.25-0.52 mm²</td> <td>1.7</td> <td>4 mm</td> </tr> </tbody> </table>	Wire gauge	max. insulation diameter	Stripping length	0.09-0.25 mm ²	1.7	4 mm	0.13-0.33 mm ²	1.7	4 mm	0.25-0.52 mm ²	1.7	4 mm
	Wire gauge	max. insulation diameter	Stripping length													
	0.09-0.25 mm ²	1.7	4 mm													
0.13-0.33 mm ²	1.7	4 mm														
0.25-0.52 mm ²	1.7	4 mm														
0.13 – 0.33	09 67 000 5576	09 67 000 5476														
0.25 – 0.52	09 67 000 8576	09 67 000 8476														

Features

- According to USB 2.0 / USB 3.0 specification
- Simple and cost effective termination by plug in patch cable
- Cable tie strain relief

Technical characteristics

Contacts	4, 8
Electrical data acc. to IEC 61984	1 A 50 V 0.8 kV 3
Rated current	1 A
Rated voltage	50 V
Rated impulse voltage	0.8 kV
Pollution degree	3
Rated voltage acc. to UL	30 V
Insulation resistance	≥10 ¹⁰ Ohm
Limiting temperatures	-40 °C ... 85 °C
Flammability (insert) acc. to UL 94	V 0
Mating cycles	≥500
Material (insert)	polycarbonate
Colour (insert)	RAL 7032 (light grey)

Specifications and approvals





IEC 60664-1
IEC 61984

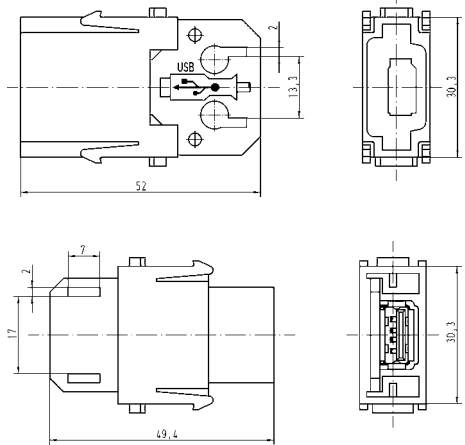
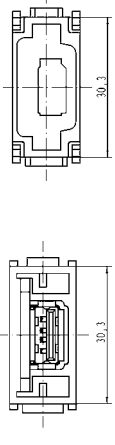

Number of contacts

4,8

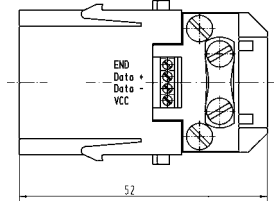
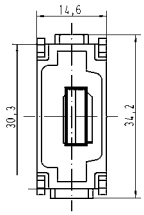
50 V
1 A

Identification	Part number		Drawing	
	male	female	Dimensions in mm	
Han-Modular®, Han® USB module, Module for patch cable, USB 2.0 	09 14 001 4601	09 14 001 4701		
Han-Modular®, Han® USB module, Module for screw termination, USB 2.0 	09 14 001 4651			
Han-Modular®, Han® USB module, Module for patch cable, USB 3.0 		09 14 001 4703		

Han-Modular

Number of contacts

6

50 V
1 A

Features

- Compatible to IEEE 1394
- Simple and cost effective termination by plug in patch cable
- Cable tie strain relief

Technical characteristics

Contacts	6
Electrical data acc. to IEC 61984	1 A 50 V 0.8 kV 3
Rated current	1 A
Rated voltage	50 V
Rated impulse voltage	0.8 kV
Pollution degree	3
Insulation resistance	≥10 ¹⁰ Ohm
Limiting temperatures	-40 °C ... 85 °C
Flammability (insert) acc. to UL 94	V 0
Mating cycles	≥500
Material (insert)	polycarbonate
Colour (insert)	RAL 7032 (light grey)

Specifications and approvals

IEC 60664-1
IEC 61984

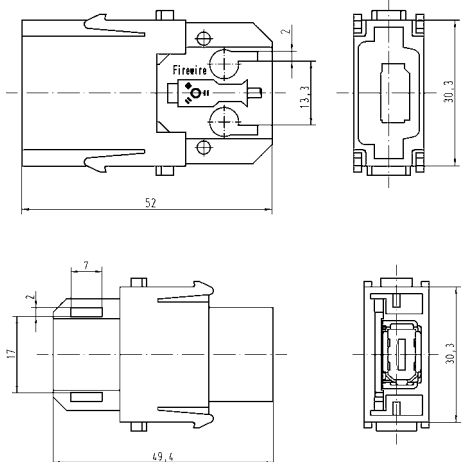

Han-Modular

Identification	Part number		Drawing	
	male	female	Dimensions in mm	
Han-Modular®, Han® FireWire module, Module for patch cable 	09 14 001 4611	09 14 001 4711		

Number of contacts

8

50 V
1 A

Features

- Single module with standard shielded RJ45 plug and jack
- Cat 6 for all data pairs (all 8 pins)
- RoHS compliant
- Patch cables are assembled/removed without tools

Technical characteristics

Contacts	8
Electrical data acc. to IEC 61984	1 A 50 V 0.8 kV 3
Rated current	1 A
Rated voltage	50 V
Rated impulse voltage	0.8 kV
Pollution degree	3
Rated voltage acc. to UL	30 V
Insulation resistance	≥10 ¹⁰ Ohm
Limiting temperatures	-40 °C ... 70 °C
Flammability (insert) acc. to UL 94	V 0
Mating cycles	≥500
Material (insert)	polycarbonate
Colour (insert)	RAL 7032 (light grey)
Transmission characteristics	Category 6 / Class E up to 250 MHz, according to ISO/IEC 11801:2002 and EN 50 173-1
Data rate copper	10 Mbit/s, 100 Mbit/s, 1000 Mbit/s, 10000 Mbit/s

Han-Modular

Specifications and approvals

IEC 60664-1
IEC 61984



Identification

Han-Modular®,
Han® RJ45 module,
Gender changer,
for patch cable,
Cat. 6



Part number

09 14 001 4721

Drawing Dimensions in mm

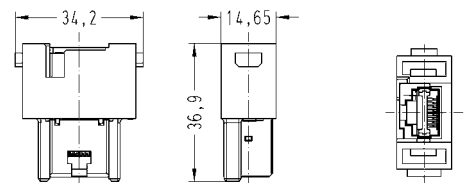

Number of contacts

8

50 V
1 A

Features

- Single module with standard shielded RJ45 plug and jack
- RoHS compliant
- The RJ45 inserts are protected by a reliable plastic insulator
- Patch cables are assembled/removed without tools

Han-Modular

Technical characteristics

Contacts	8
Electrical data acc. to IEC 61984	1 A 50 V 0.8 kV 3
Rated current	1 A
Rated voltage	50 V
Rated impulse voltage	0.8 kV
Pollution degree	3
Rated voltage acc. to UL	30 V
Insulation resistance	$\geq 10^{10}$ Ohm
Limiting temperatures	-40 °C ... 70 °C
Flammability (insert) acc. to UL 94	V 0
Mating cycles	≥ 500
Material (insert)	polycarbonate
Colour (insert)	RAL 7032 (light grey)

Specifications and approvals

IEC 60664-1
IEC 61984



Identification

Part number

Drawing Dimensions in mm

Han-Modular®,
Adapter,
for patch cable



09 14 000 9966

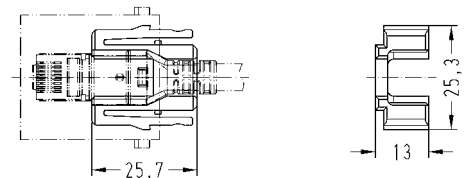

Han-Modular®,
Han® RJ45 module,
for adapter



09 14 001 4623

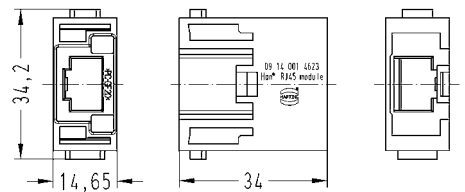

Number of contacts

8

50 V
1 A

Features

- Single module with standard shielded RJ45 plug and jack
- RoHS compliant
- The RJ45 inserts are protected by a reliable plastic insulator

Technical characteristics

Contacts	8
Electrical data acc. to IEC 61984	1 A 50 V 0.8 kV 3
Rated current	1 A
Rated voltage	50 V
Rated impulse voltage	0.8 kV
Pollution degree	3
Rated voltage acc. to UL	30 V
Insulation resistance	$\geq 10^{10}$ Ohm
Limiting temperatures	-40 °C ... 70 °C
Flammability (insert) acc. to UL 94	V 0
Mating cycles	≥ 500
Material (insert)	polycarbonate
Colour (insert)	RAL 7032 (light grey)

Specifications and approvals

IEC 60664-1
IEC 61984



Han-
Modular

Identification

Han-Modular®,
Han® RJ45 module,
for crimp inserts



Part number

09 14 001 4622

Drawing Dimensions in mm

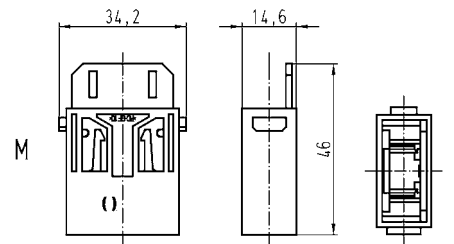

Han-Modular®,
Insert for Han® RJ45 module,
Cat. 5e



09 12 000 9958

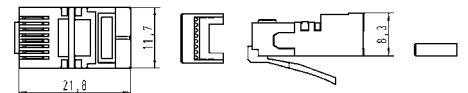

Number of contacts

4,8

50 V
1 A

Features

- Single module with standard shielded RJ45 plug and jack
- The RJ45 inserts are protected by a reliable plastic insulator
- 360° shielded contact
- Field assembly without tools possible by means of HARAX® rapid termination in IDC technology
- Gigalink: Field assembly by means of piercing contacts
- Suitable for termination of massive and flexible wires
- Gigalink: Suitable for termination of flexible wires

Technical characteristics

Contacts	8, 4
Electrical data acc. to IEC 61984	1 A 50 V 0.8 kV 3
Rated current	1 A
Rated voltage	50 V
Rated impulse voltage	0.8 kV
Pollution degree	3
Rated voltage acc. to UL	30 V
Insulation resistance	≥10 ¹⁰ Ohm
Limiting temperatures	-40 °C ... 70 °C
Flammability (insert) acc. to UL 94	V 0
Mating cycles	≥500
Material (insert)	polycarbonate, polyamide
Colour (insert)	RAL 7032 (light grey)
Transmission characteristics	Category 6a / Class EA up to 500 MHz, according to ISO/IEC 11 801:2002 and EN 50 173-1, Category 5 / Class D up to 100 MHz, according to ISO/IEC 11 801:2002 and EN 50 173-1, Category 6 / Class E up to 250 MHz, according to ISO/IEC 11 801:2002 and EN 50 173-1
Data rate copper	10 Mbit/s, 100 Mbit/s, 1000 Mbit/s, 10000 Mbit/s

Specifications and approvals

IEC 60664-1
IEC 61984
IEC 60603-7



Identification

Han-Modular®,
Han® RJ45 module,
for adapter







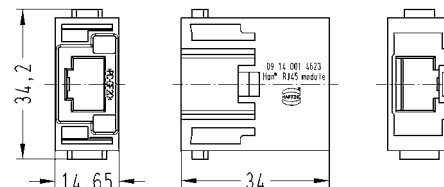

Part number

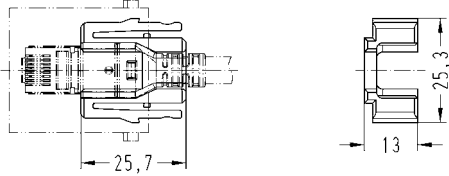
09 14 001 4623

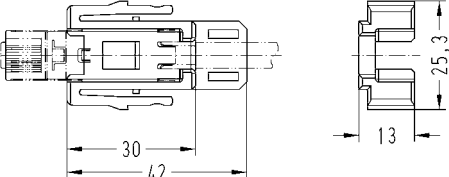
Drawing Dimensions in mm

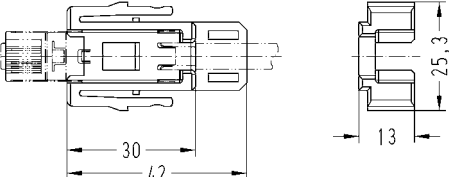

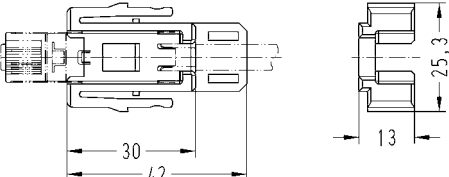
Identification	Part number	Drawing Dimensions in mm
<p>Han-Modular®, Han® RJ Industrial adapter, RJ Industrial RJ45 Gigalink connector set, AWG 28 ... 24, 10 Mbit/s, 100 Mbit/s, 1000 Mbit/s, 10000 Mbit/s, IDC contacts, Cat. 6a</p> 	09 45 400 1520	 <p>Wire outside diameter ≤ 1.05 mm</p>
<p>Han-Modular®, Han® RJ Industrial adapter, RJ Industrial RJ45 connector set, AWG 24 ... 22, 10 Mbit/s, 100 Mbit/s, IDC contacts, Cat. 5</p> 	09 45 400 1100	 <p>Wire outside diameter ≤ 1.6 mm</p>
<p>Han-Modular®, Han® RJ Industrial adapter, RJ Industrial RJ45 connector set, AWG 26, 10 Mbit/s, 100 Mbit/s, IDC contacts, Cat. 5</p> 	09 45 400 1109	 <p>Wire outside diameter ≤ 1.6 mm</p>
<p>Han-Modular®, Han® RJ Industrial adapter, RJ Industrial RJ45 connector set, AWG 27 ... 22, 10 Mbit/s, 100 Mbit/s, 1000 Mbit/s, 10000 Mbit/s, IDC contacts, Cat. 6</p> 	09 45 400 1560	 <p>Wire outside diameter ≤ 1.5 mm</p>



Features

- Locking lever protection for RJ45 connector latch
- Very short plug design in combination with robust bend protection
- RoHS compliant
- Fully EMC screened (aluminium-clad foil and braid)

Technical characteristics

Limiting temperatures	-40 °C ... 80 °C
Limiting temperatures (flexible)	0 °C ... 60 °C
Flammability (cable) acc. to UL 94	flame retardant, halogen-free
Degree of protection acc. to IEC 60529	IP20
Material (cable)	SF/UTP, PUR, PUR Elastomer yellow
Colour (cable)	1:1 EIA/TIA 568 B, 8 poles
Cable type, copper	Category 5 / Class D up to 100 MHz, according to ISO/IEC 24702 or ISO/IEC 11 801, Category 5e / Class D up to 100 MHz, according to ISO/IEC 61 935-2
Transmission characteristics	10 Mbit/s, 100 Mbit/s, 1000 Mbit/s
Data rate copper	

Specifications and approvals

ISO/IEC 11801
 ISO/IEC 24702
 ISO/IEC 61935-2

Identification

RJ45 patch cable,
 Cat. 5e



Cable length

0.2 m
 0.3 m
 0.4 m
 0.5 m
 0.6 m
 0.7 m
 0.8 m
 0.9 m
 1 m
 2 m
 3 m
 4 m
 5 m
 6 m
 7 m
 8 m
 9 m
 10 m
 15 m
 20 m
 1.5 m
 2.5 m
 7.5 m

Part number

09 47 474 7001
 09 47 474 7002
 09 47 474 7003
 09 47 474 7004
 09 47 474 7005
 09 47 474 7006
 09 47 474 7007
 09 47 474 7008
 09 47 474 7009
 09 47 474 7011
 09 47 474 7013
 09 47 474 7014
 09 47 474 7015
 09 47 474 7016
 09 47 474 7017
 09 47 474 7019
 09 47 474 7020
 09 47 474 7021
 09 47 474 7022
 09 47 474 7023
 09 47 474 7010
 09 47 474 7012
 09 47 474 7018

Drawing Dimensions in mm

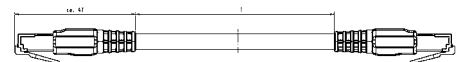



Features

- Locking lever protection for RJ45 connector latch
- Very short plug design in combination with robust bend protection
- RoHS compliant
- Fully EMC screened (aluminium-clad foil and braid)

Technical characteristics

Limiting temperatures	-40 °C ... 80 °C
Limiting temperatures (flexible)	0 °C ... 60 °C
Flammability (cable) acc. to UL 94	flame retardant, halogen-free
Degree of protection acc. to IEC 60529	IP20
Material (cable)	SF/UTP, PUR
Colour (cable)	yellow
Cable type, copper	1:1 EIA/TIA 568 B, 8 poles
Transmission characteristics	Category 6 / Class E up to 250 MHz, according to ISO/IEC 24702 or ISO/IEC 11 801, Category 6 / Class E up to 250 MHz, according to ISO/IEC 61 935-2
Data rate copper	10 Mbit/s, 100 Mbit/s, 1000 Mbit/s

Han-Modular

Specifications and approvals

ISO/IEC 11801
ISO/IEC 24702
ISO/IEC 61935-2

Identification	Cable length	Part number	Drawing Dimensions in mm
RJ45 patch cable, Cat. 6	0.2 m	09 47 474 7101	
	0.3 m	09 47 474 7102	
	0.4 m	09 47 474 7103	
	0.5 m	09 47 474 7104	
	0.6 m	09 47 474 7105	
	0.7 m	09 47 474 7106	
	0.8 m	09 47 474 7107	
	0.9 m	09 47 474 7108	
	1 m	09 47 474 7109	
	2 m	09 47 474 7111	
	3 m	09 47 474 7113	
	4 m	09 47 474 7114	
	5 m	09 47 474 7115	
	6 m	09 47 474 7116	
	7 m	09 47 474 7117	
	8 m	09 47 474 7119	
	9 m	09 47 474 7120	
	10 m	09 47 474 7121	
	15 m	09 47 474 7122	
	20 m	09 47 474 7123	
1.5 m	09 47 474 7110		
2.5 m	09 47 474 7112		
7.5 m	09 47 474 7118		

Features

- Shielding bus separate from housing potential
- Suitable for the transmission of sensitive signals (e.g. bus signals)
- Usuable for Gigabit Ethernet Cat. 6A

Technical characteristics

Contacts	8
Electrical data acc. to IEC 61984	5 A 50 V 0.8 kV 3
Rated current	5 A
Rated voltage	50 V
Rated impulse voltage	0.8 kV
Pollution degree	3
Insulation resistance	$\geq 10^{10}$ Ohm
Limiting temperatures	-40 °C ... 85 °C
Flammability (insert) acc. to UL 94	V 0
Mating cycles	≥ 500
Material (insert)	polycarbonate
Colour (insert)	RAL 7032 (light grey)
Material (shielding element)	zinc die-cast alloy
Material (outer conductor)	zinc alloy
Surface (outer conductor)	nickel plated contacts

Specifications and approvals



IEC 61984
IEC 60664-1



Number of contacts

8

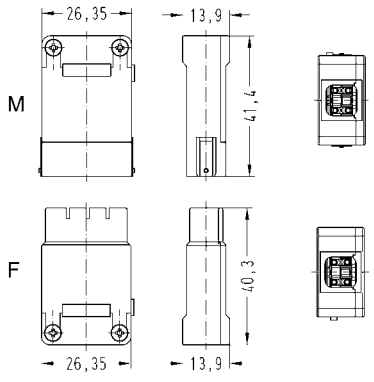
50 V
5 A
+ shielding

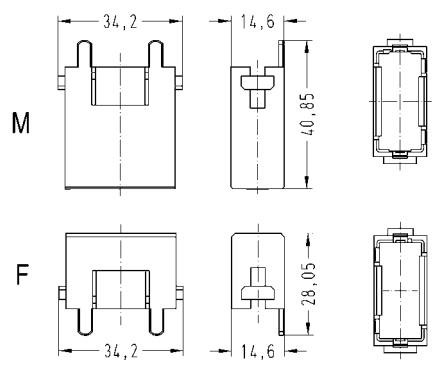
Identification	Wire cross section (mm ²)	Part number male female		Drawing Dimensions in mm												
<p>Han-Modular®, Han® GigaBit Insert, Crimp terminal</p>  <p>Please order crimp contacts separately. Please order the adapter module separately.</p>		09 14 008 3011	09 14 008 3111	 <p>Cable outside diameter 5 ... 12</p>												
<p>Han-Modular®, Adapter module</p>  <p>Han® D-Sub crimp contact, turned contacts</p> 	<p>0.09 – 0.25 0.13 – 0.33 0.25 – 0.52</p>	<p>09 14 001 3011</p> <p>09 67 000 7576 09 67 000 5576 09 67 000 8576</p>	<p>09 14 001 3111</p> <p>09 67 000 7476 09 67 000 5476 09 67 000 8476</p>	 <table border="1" data-bbox="1037 1545 1500 1680"> <thead> <tr> <th>Wire gauge</th> <th>max. insulation diameter</th> <th>Stripping length</th> </tr> </thead> <tbody> <tr> <td>0.09-0.25 mm²</td> <td>1.7</td> <td>4 mm</td> </tr> <tr> <td>0.13-0.33 mm²</td> <td>1.7</td> <td>4 mm</td> </tr> <tr> <td>0.25-0.52 mm²</td> <td>1.7</td> <td>4 mm</td> </tr> </tbody> </table>	Wire gauge	max. insulation diameter	Stripping length	0.09-0.25 mm ²	1.7	4 mm	0.13-0.33 mm ²	1.7	4 mm	0.25-0.52 mm ²	1.7	4 mm
Wire gauge	max. insulation diameter	Stripping length														
0.09-0.25 mm ²	1.7	4 mm														
0.13-0.33 mm ²	1.7	4 mm														
0.25-0.52 mm ²	1.7	4 mm														

Han-Modular

Features

- Shielding bus separate from housing potential
- Suitable for the transmission of sensitive signals (e.g. bus signals)

Technical characteristics

Contacts	20
Electrical data acc. to IEC 61984	4 A 32 V 0.8 V 3
Rated current	4 A
Rated voltage	32 V
Rated impulse voltage	0.8 V
Pollution degree	3
Insulation resistance	≥10 ¹⁰ Ohm
Limiting temperatures	-40 °C ... 125 °C -40 °C ... 85 °C
Flammability (insert) acc. to UL 94	V 0
Mating cycles	≥500
Material (insert)	polycarbonate
Colour (insert)	RAL 7032 (light grey)
Material (contact)	copper alloy
Material (shielding element)	zinc die-cast alloy
Material (outer conductor)	zinc alloy
Surface (outer conductor)	nickel plated contacts

Specifications and approvals



IEC 60664-1
IEC 61984



Number of contacts

20

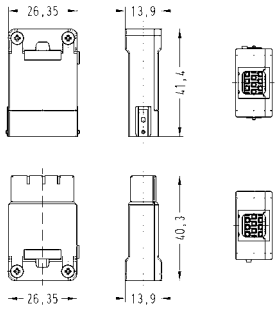
32 V
4 A
+ shielding

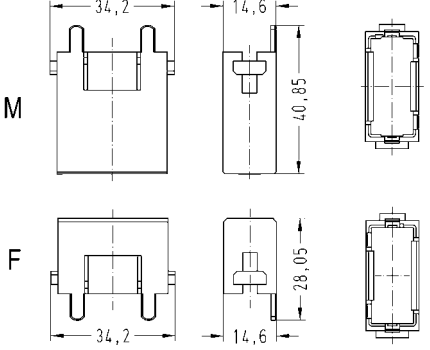
Identification	Wire cross section (mm ²)	Part number		Drawing Dimensions in mm												
		male	female													
Han-Modular®, Han® Shielded Module insert, Crimp terminal, contact resistance ≤4 mOhm  Please order crimp contacts separately. Please order the adapter module separately.		09 14 020 3013	09 14 020 3113													
Han-Modular®, Adapter module  Han® D-Sub crimp contact, turned contacts 	0.09–0.25 0.13–0.33 0.25–0.52	09 14 001 3011 09 67 000 7576 09 67 000 5576 09 67 000 8576	09 14 001 3111 09 67 000 7476 09 67 000 5476 09 67 000 8476	 <table border="1"> <thead> <tr> <th>Wire gauge</th> <th>max. insulation diameter</th> <th>Stripping length</th> </tr> </thead> <tbody> <tr> <td>0.09-0.25 mm²</td> <td>1.7</td> <td>4 mm</td> </tr> <tr> <td>0.13-0.33 mm²</td> <td>1.7</td> <td>4 mm</td> </tr> <tr> <td>0.25-0.52 mm²</td> <td>1.7</td> <td>4 mm</td> </tr> </tbody> </table>	Wire gauge	max. insulation diameter	Stripping length	0.09-0.25 mm ²	1.7	4 mm	0.13-0.33 mm ²	1.7	4 mm	0.25-0.52 mm ²	1.7	4 mm
Wire gauge	max. insulation diameter	Stripping length														
0.09-0.25 mm ²	1.7	4 mm														
0.13-0.33 mm ²	1.7	4 mm														
0.25-0.52 mm ²	1.7	4 mm														

Han-Modular

Features

- Shielding bus separate from housing potential
- Usuable for MegaBit Ethernet Cat. 5e
- Suitable for Han B, Han M, Han EMC and Han HPR hoods/housings, high construction

Technical characteristics

Contacts	2 x 4
Electrical data acc. to IEC 61984	10 A 50 V 0.8 kV 3
Rated current	10 A
Rated voltage	50 V
Rated impulse voltage	0.8 kV
Pollution degree	3
Insulation resistance	≥10 ¹⁰ Ohm
Limiting temperatures	-40 °C ... 125 °C -40 °C ... 85 °C
Flammability (insert) acc. to UL 94	V 0
Mating cycles	≥500
Material (insert)	polycarbonate
Colour (insert)	RAL 7032 (light grey)
Material (contact)	copper alloy
Material (shielding element)	zinc die-cast alloy
Material (outer conductor)	zinc alloy
Surface (outer conductor)	nickel plated contacts

Specifications and approvals

IEC 60664-1
IEC 61984



Details

Crimping tools see chapter 90



Remarks on the crimp technique

The wire gauges mentioned in the catalogue refer to geometric wire gauges of cables.

Number of contacts

2 x 4

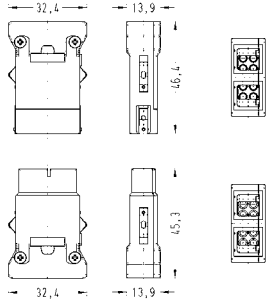
50 V
10 A

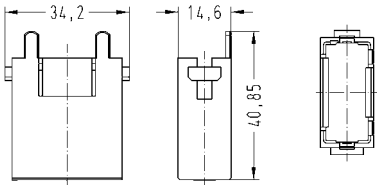
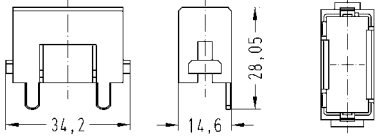
Identification	Wire cross section (mm²)	Part number		Drawing Dimensions in mm
		male	female	
<p>Han-Modular®, Han® MegaBit Insert, Crimp terminal</p>  <p>Please order crimp contacts separately. Please order the adapter module separately.</p>		09 14 008 3016	09 14 008 3116	
<p>Han-Modular®, Han® MegaBit Insert, Crimp terminal, with additional shield connection to the hinged frame</p>  <p>Please order crimp contacts separately. Please order the adapter module separately.</p>		09 14 008 3017	09 14 008 3117	
<p>Han-Modular®, Adapter module</p> 		09 14 001 3011	09 14 001 3111	<p>M</p>  <p>F</p> 



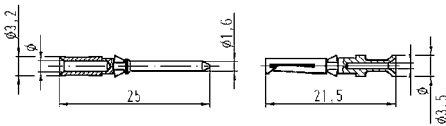

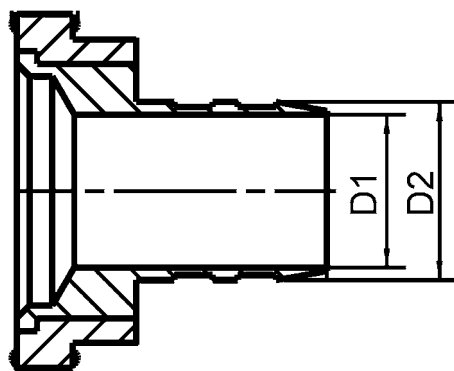
Han-Modular

Identification	Wire cross section (mm ²)	Part number		Drawing Dimensions in mm																					
		male	female																						
Han D®, Crimp contact, gold plated contacts, contact resistance ≤3 mOhm 	0.14–0.37	09 15 000 6124	09 15 000 6224	 <table border="1"> <thead> <tr> <th>Wire gauge</th> <th>Ø</th> <th>Stripping length</th> </tr> </thead> <tbody> <tr> <td>0.14-0.37 mm² AWG 26-22</td> <td>0.9 mm</td> <td>8 mm</td> </tr> <tr> <td>0.5 mm² AWG 20</td> <td>1.1 mm</td> <td>8 mm</td> </tr> <tr> <td>0.75 mm² AWG 18</td> <td>1.3 mm</td> <td>8 mm</td> </tr> <tr> <td>1 mm² AWG 18</td> <td>1.45 mm</td> <td>8 mm</td> </tr> <tr> <td>1.5 mm² AWG 16</td> <td>1.75 mm</td> <td>8 mm</td> </tr> <tr> <td>2.5 mm² AWG 14</td> <td>2.25 mm</td> <td>6 mm</td> </tr> </tbody> </table>	Wire gauge	Ø	Stripping length	0.14-0.37 mm ² AWG 26-22	0.9 mm	8 mm	0.5 mm ² AWG 20	1.1 mm	8 mm	0.75 mm ² AWG 18	1.3 mm	8 mm	1 mm ² AWG 18	1.45 mm	8 mm	1.5 mm ² AWG 16	1.75 mm	8 mm	2.5 mm ² AWG 14	2.25 mm	6 mm
	Wire gauge	Ø	Stripping length																						
	0.14-0.37 mm ² AWG 26-22	0.9 mm	8 mm																						
	0.5 mm ² AWG 20	1.1 mm	8 mm																						
	0.75 mm ² AWG 18	1.3 mm	8 mm																						
	1 mm ² AWG 18	1.45 mm	8 mm																						
	1.5 mm ² AWG 16	1.75 mm	8 mm																						
2.5 mm ² AWG 14	2.25 mm	6 mm																							
0.5	09 15 000 6123	09 15 000 6223																							
0.75	09 15 000 6125	09 15 000 6225																							
1	09 15 000 6122	09 15 000 6222																							
1.5	09 15 000 6121	09 15 000 6221																							
2.5	09 15 000 6126	09 15 000 6226																							

Identification	D1	D2	Part number	Drawing Dimensions in mm
<p data-bbox="119 607 263 645">Crimp flange</p>  <p data-bbox="119 817 462 918">HARTING offers to test and define the best crimp flange and ferrule combination for customer specific cables.</p>	<p data-bbox="486 607 566 929">3 mm 4 mm 5 mm 6 mm 7 mm 8 mm 9 mm 3.5 mm 4.5 mm 5.5 mm 6.5 mm 7.5 mm 8.5 mm</p>	<p data-bbox="651 607 730 929">4 mm 5 mm 6 mm 7 mm 8 mm 9 mm 10 mm 4 mm 5.5 mm 6.5 mm 7.5 mm 8.5 mm 9.5 mm</p>	<p data-bbox="810 607 970 929">61 03 000 0062 61 03 000 0064 61 03 000 0066 61 03 000 0067 61 03 000 0069 61 03 000 0071 61 03 000 0072 61 03 000 0063 61 03 000 0065 61 03 000 0166 61 03 000 0068 61 03 000 0070 61 03 000 0165</p>	

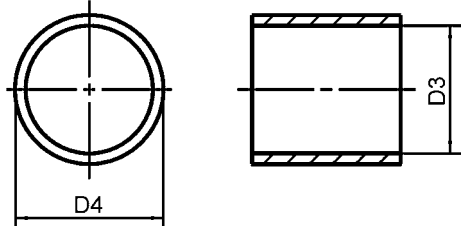
Han-Modular

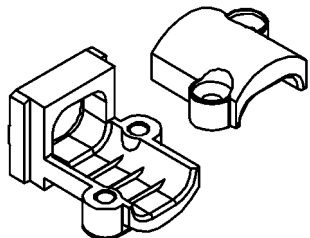
Han-Modular

Identification	D3	D4	Part number	Drawing Dimensions in mm
<p>Crimp ferrule</p>  <p>HARTING offers to test and define the best crimp flange and ferrule combination for customer specific cables.</p>	5 mm 6 mm 7 mm 8 mm 9 mm 10 mm 11 mm 12 mm 13 mm 5.5 mm 6.5 mm 7.5 mm 8.5 mm 9.5 mm 10.5 mm 11.5 mm 12.5 mm	6 mm 7 mm 8 mm 9 mm 10 mm 11 mm 12 mm 13 mm 14 mm 6.5 mm 7.5 mm 8.5 mm 9.5 mm 10.5 mm 11.5 mm 12.5 mm 13.5 mm	61 03 000 0045 61 03 000 0047 61 03 000 0049 61 03 000 0051 61 03 000 0053 61 03 000 0055 61 03 000 0057 61 03 000 0142 61 03 000 0127 61 03 000 0046 61 03 000 0048 61 03 000 0050 61 03 000 0052 61 03 000 0054 61 03 000 0056 61 03 000 0058 61 03 000 0059	
<p>Cable clamp 5 mm ... 7 mm</p> 			61 03 000 0141	
<p>Cable clamp 7 mm ... 10 mm</p> 			61 03 000 0044	
<p>Cable clamp 10 mm ... 12 mm</p> 			61 03 000 0143	

Features

- Shielding bus separate from housing potential
- Suitable for the transmission of sensitive signals (e.g. bus signals)
- The four pole Han® Quintax contact is suitable for Ethernet Cat. 5e and PROFIBUS when diagonally wiring of the data pairs

Technical characteristics

Contacts	2
Electrical data acc. to IEC 61984	10 A 50 V 0.8 kV 3
Rated current	10 A
Rated voltage	50 V
Rated impulse voltage	0.8 kV
Pollution degree	3
Insulation resistance	≥10 ¹⁰ Ohm
Limiting temperatures	-40 °C ... 85 °C
Flammability (insert) acc. to UL 94	V 0
Mating cycles	≥500
Material (insert)	polycarbonate, zinc alloy
Colour (insert)	RAL 7032 (light grey)
Material (contact)	copper alloy
Material (accessories)	metal

Specifications and approvals

IEC 60664-1
IEC 61984



Details

Crimping tools see chapter 90







Remarks on the crimp technique

The wire gauges mentioned in the catalogue refer to geometric wire gauges of cables.

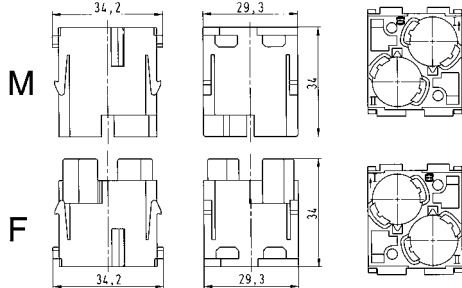
Number of contacts

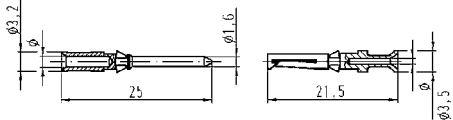
2

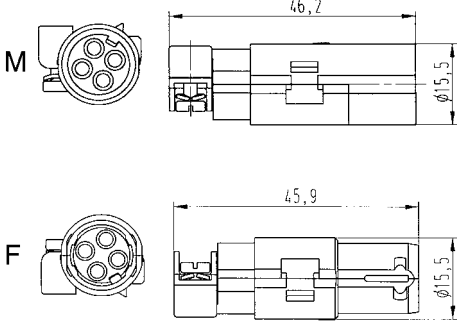
Han-Modular

Identification	Wire cross section (mm ²)	Part number male female		Drawing Dimensions in mm																					
<p>Han-Modular®, Han-Quintax® module, Crimp terminal</p> 		09 14 002 3001	09 14 002 3101	 <p>Contact arrangement (view from termination side)</p>																					
<p>Han D®, Crimp contact, gold plated contacts, contact resistance ≤3 mOhm</p> 	0.14–0.37 0.5 0.75 1 1.5 2.5	09 15 000 6124 09 15 000 6123 09 15 000 6125 09 15 000 6122 09 15 000 6121 09 15 000 6126	09 15 000 6224 09 15 000 6223 09 15 000 6225 09 15 000 6222 09 15 000 6221 09 15 000 6226	 <table border="1" data-bbox="1007 1205 1465 1361"> <thead> <tr> <th>Wire gauge</th> <th>∅</th> <th>Stripping length</th> </tr> </thead> <tbody> <tr> <td>0.14-0.37 mm² AWG 26-22</td> <td>0.9 mm</td> <td>8 mm</td> </tr> <tr> <td>0.5 mm² AWG 20</td> <td>1.1 mm</td> <td>8 mm</td> </tr> <tr> <td>0.75 mm² AWG 18</td> <td>1.3 mm</td> <td>8 mm</td> </tr> <tr> <td>1 mm² AWG 18</td> <td>1.45 mm</td> <td>8 mm</td> </tr> <tr> <td>1.5 mm² AWG 16</td> <td>1.75 mm</td> <td>8 mm</td> </tr> <tr> <td>2.5 mm² AWG 14</td> <td>2.25 mm</td> <td>6 mm</td> </tr> </tbody> </table>	Wire gauge	∅	Stripping length	0.14-0.37 mm ² AWG 26-22	0.9 mm	8 mm	0.5 mm ² AWG 20	1.1 mm	8 mm	0.75 mm ² AWG 18	1.3 mm	8 mm	1 mm ² AWG 18	1.45 mm	8 mm	1.5 mm ² AWG 16	1.75 mm	8 mm	2.5 mm ² AWG 14	2.25 mm	6 mm
Wire gauge	∅	Stripping length																							
0.14-0.37 mm ² AWG 26-22	0.9 mm	8 mm																							
0.5 mm ² AWG 20	1.1 mm	8 mm																							
0.75 mm ² AWG 18	1.3 mm	8 mm																							
1 mm ² AWG 18	1.45 mm	8 mm																							
1.5 mm ² AWG 16	1.75 mm	8 mm																							
2.5 mm ² AWG 14	2.25 mm	6 mm																							
<p>Han-Quintax® contact, 4 + shielding, for Han D® crimp contacts</p>  <p>Please order crimp contacts separately.</p>		09 15 004 3013	09 15 004 3113																						
<p>Han-Quintax®, Adapter</p>  <p>optional</p>		09 14 000 9915	09 14 000 9915																						

Technical characteristics

Contacts	2
Electrical data acc. to IEC 61984	5 A 50 V 0.8 kV 3
Rated current	5 A
Rated voltage	50 V
Rated impulse voltage	0.8 kV
Pollution degree	3
Insulation resistance	≥10 ¹⁰ Ohm
Limiting temperatures	-40 °C ... 85 °C
Flammability (insert) acc. to UL 94	V 0

Technical characteristics

Mating cycles	≥500
Material (insert)	polycarbonate
Colour (insert)	RAL 7032 (light grey)
Material (accessories)	metal

Specifications and approvals





IEC 60664-1
IEC 61984

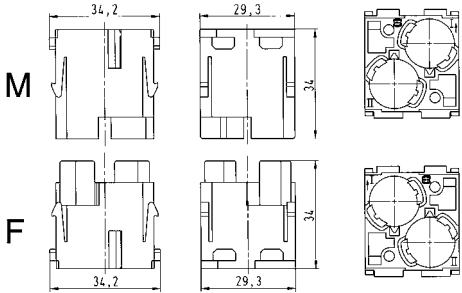

Number of contacts

2

Han-Modular

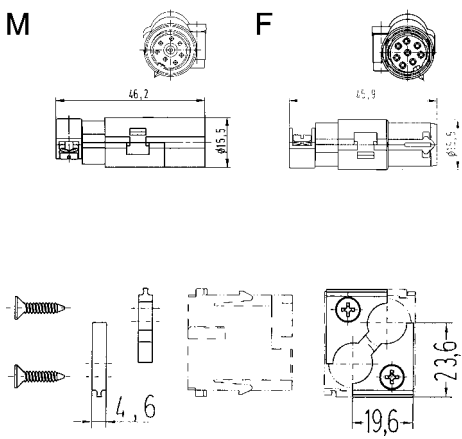
Identification	Wire cross section (mm ²)	Part number		Drawing Dimensions in mm												
		male	female													
Han-Modular®, Han-Quintax® module, Crimp terminal 		09 14 002 3001	09 14 002 3101	 <p>Contact arrangement (view from termination side)</p>												
Han-Modular®, Han-Quintax® High Density contact, 8 + shielding, for Han® D-Sub contacts  <p>Please order contacts separately.</p> Han-Quintax®, Adapter  <p>optional</p> Han® D-Sub crimp contact, turned contacts 	0.09–0.25 0.13–0.33 0.25–0.52	09 15 008 3013 09 14 000 9915 09 67 000 7576 09 67 000 5576 09 67 000 8576	09 15 008 3113 09 14 000 9915 09 67 000 7476 09 67 000 5476 09 67 000 8476	 <table border="1" data-bbox="1005 1590 1468 1724"> <thead> <tr> <th>Wire gauge</th> <th>max. insulation diameter</th> <th>Stripping length</th> </tr> </thead> <tbody> <tr> <td>0.09-0.25 mm²</td> <td>1.7</td> <td>4 mm</td> </tr> <tr> <td>0.13-0.33 mm²</td> <td>1.7</td> <td>4 mm</td> </tr> <tr> <td>0.25-0.52 mm²</td> <td>1.7</td> <td>4 mm</td> </tr> </tbody> </table>	Wire gauge	max. insulation diameter	Stripping length	0.09-0.25 mm ²	1.7	4 mm	0.13-0.33 mm ²	1.7	4 mm	0.25-0.52 mm ²	1.7	4 mm
Wire gauge	max. insulation diameter	Stripping length														
0.09-0.25 mm ²	1.7	4 mm														
0.13-0.33 mm ²	1.7	4 mm														
0.25-0.52 mm ²	1.7	4 mm														

Technical characteristics

Contacts	2
Electrical data acc. to IEC 61984	10 A 50 V 0.8 kV 3
Rated current	10 A
Rated voltage	50 V
Rated impulse voltage	0.8 kV
Pollution degree	3
Insulation resistance	≥10 ¹⁰ Ohm
Limiting temperatures	-40 °C ... 85 °C
Flammability (insert) acc. to UL 94	V 0
Mating cycles	≥500
Material (insert)	polycarbonate, zinc alloy
Colour (insert)	RAL 7032 (light grey)
Material (contact)	copper alloy

Specifications and approvals

IEC 60664-1
IEC 61984



Details

Crimping tools see chapter 90





Remarks on the crimp technique

The wire gauges mentioned in the catalogue refer to geometric wire gauges of cables.

Number of contacts

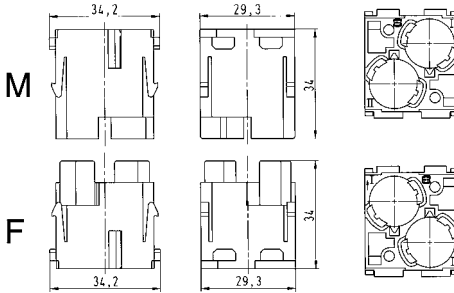
2

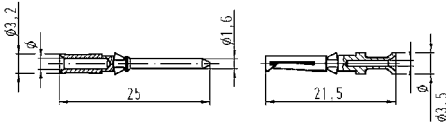
Han-Modular

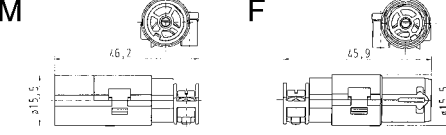
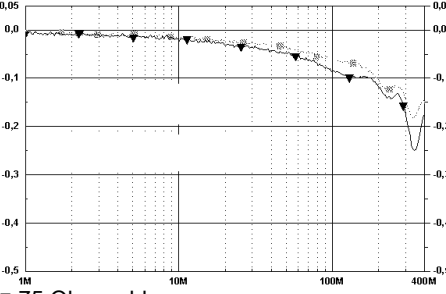
Identification	Wire cross section (mm ²)	Part number		Drawing Dimensions in mm																					
		male	female																						
Han-Modular®, Han-Quintax® module, Crimp terminal 		09 14 002 3001	09 14 002 3101	 <p>M</p> <p>F</p> <p>Contact arrangement (view from termination side)</p>																					
Han D®, Crimp contact, gold plated contacts, contact resistance ≤3 mOhm 	0.14–0.37 0.5 0.75 1 1.5 2.5	09 15 000 6124 09 15 000 6123 09 15 000 6125 09 15 000 6122 09 15 000 6121 09 15 000 6126	09 15 000 6224 09 15 000 6223 09 15 000 6225 09 15 000 6222 09 15 000 6221 09 15 000 6226	 <table border="1" data-bbox="1013 1198 1460 1355"> <thead> <tr> <th>Wire gauge</th> <th>∅</th> <th>Stripping length</th> </tr> </thead> <tbody> <tr> <td>0.14-0.37 mm² AWG 26-22</td> <td>0.9 mm</td> <td>8 mm</td> </tr> <tr> <td>0.5 mm² AWG 20</td> <td>1.1 mm</td> <td>8 mm</td> </tr> <tr> <td>0.75 mm² AWG 18</td> <td>1.3 mm</td> <td>8 mm</td> </tr> <tr> <td>1 mm² AWG 18</td> <td>1.45 mm</td> <td>8 mm</td> </tr> <tr> <td>1.5 mm² AWG 16</td> <td>1.75 mm</td> <td>8 mm</td> </tr> <tr> <td>2.5 mm² AWG 14</td> <td>2.25 mm</td> <td>6 mm</td> </tr> </tbody> </table>	Wire gauge	∅	Stripping length	0.14-0.37 mm ² AWG 26-22	0.9 mm	8 mm	0.5 mm ² AWG 20	1.1 mm	8 mm	0.75 mm ² AWG 18	1.3 mm	8 mm	1 mm ² AWG 18	1.45 mm	8 mm	1.5 mm ² AWG 16	1.75 mm	8 mm	2.5 mm ² AWG 14	2.25 mm	6 mm
Wire gauge	∅	Stripping length																							
0.14-0.37 mm ² AWG 26-22	0.9 mm	8 mm																							
0.5 mm ² AWG 20	1.1 mm	8 mm																							
0.75 mm ² AWG 18	1.3 mm	8 mm																							
1 mm ² AWG 18	1.45 mm	8 mm																							
1.5 mm ² AWG 16	1.75 mm	8 mm																							
2.5 mm ² AWG 14	2.25 mm	6 mm																							
Coaxial contact, 1 + shielding, for Han D® crimp contacts, 75 Ohm  Please order crimp contacts separately.		09 15 001 3013	09 15 001 3113	 <p>M</p> <p>F</p> <p>RF transmission characteristics</p>  <p>■ 75 Ohm cable ▼ 75 Ohm cable with Han D® Coax</p>																					

Technical characteristics

Contacts	2
Electrical data acc. to IEC 61984	16 A 50 V 0.8 kV 3
Rated current	16 A
Rated voltage	50 V
Rated impulse voltage	0.8 kV
Pollution degree	3
Insulation resistance	≥10 ¹⁰ Ohm
Limiting temperatures	-40 °C ... 85 °C
Flammability (insert) acc. to UL 94	V 0
Mating cycles	≥500
Material (insert)	polycarbonate, zinc alloy
Colour (insert)	RAL 7032 (light grey)
Material (contact)	copper alloy

Specifications and approvals

IEC 60664-1
IEC 61984



Details

Crimping tools see chapter 90

Remarks on the crimp technique

The wire gauges mentioned in the catalogue refer to geometric wire gauges of cables.

Number of contacts

2

Han-Modular

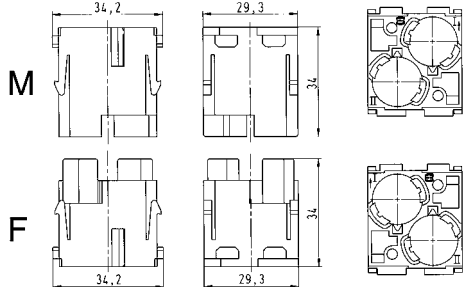
Identification	Wire cross section (mm ²)	Part number		Drawing Dimensions in mm
		male	female	
Han-Modular®, Han-Quintax® module, Crimp terminal 		09 14 002 3001	09 14 002 3101	 <p>Contact arrangement (view from termination side)</p>

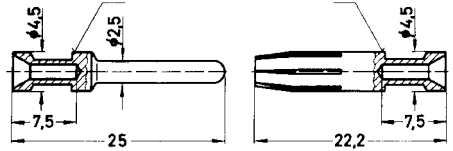
Han E®, Crimp contact, gold plated contacts, contact resistance ≤1 mOhm 	0.14–0.37 0.5 0.75 1 1.5 2.5 4 5.5	09 33 000 6117 09 33 000 6122 09 33 000 6115 09 33 000 6118 09 33 000 6116 09 33 000 6123 09 33 000 6119 09 33 000 6139	09 33 000 6217 09 33 000 6222 09 33 000 6215 09 33 000 6218 09 33 000 6216 09 33 000 6223 09 33 000 6221 09 33 000 6239	 <table border="1"> <thead> <tr> <th>Identification</th> <th>Wire gauge</th> <th>Stripping length</th> </tr> </thead> <tbody> <tr> <td>no groove</td> <td>0.14-0.37 mm² AWG 26-22</td> <td>7.5 mm</td> </tr> <tr> <td>no groove</td> <td>0.5 mm² AWG 20</td> <td>7.5 mm</td> </tr> <tr> <td>1 groove*</td> <td>0.75 mm² AWG 18</td> <td>7.5 mm</td> </tr> <tr> <td>1 groove</td> <td>1 mm² AWG 18</td> <td>7.5 mm</td> </tr> <tr> <td>2 grooves</td> <td>1.5 mm² AWG 16</td> <td>7.5 mm</td> </tr> <tr> <td>3 grooves</td> <td>2.5 mm² AWG 14</td> <td>7.5 mm</td> </tr> <tr> <td>wide groove</td> <td>3 mm² AWG 12</td> <td>7.5 mm</td> </tr> <tr> <td>no groove</td> <td>4 mm² AWG 12</td> <td>7.5 mm</td> </tr> </tbody> </table> <p>* on the back crimp collar</p>	Identification	Wire gauge	Stripping length	no groove	0.14-0.37 mm ² AWG 26-22	7.5 mm	no groove	0.5 mm ² AWG 20	7.5 mm	1 groove*	0.75 mm ² AWG 18	7.5 mm	1 groove	1 mm ² AWG 18	7.5 mm	2 grooves	1.5 mm ² AWG 16	7.5 mm	3 grooves	2.5 mm ² AWG 14	7.5 mm	wide groove	3 mm ² AWG 12	7.5 mm	no groove	4 mm ² AWG 12	7.5 mm
Identification	Wire gauge	Stripping length																													
no groove	0.14-0.37 mm ² AWG 26-22	7.5 mm																													
no groove	0.5 mm ² AWG 20	7.5 mm																													
1 groove*	0.75 mm ² AWG 18	7.5 mm																													
1 groove	1 mm ² AWG 18	7.5 mm																													
2 grooves	1.5 mm ² AWG 16	7.5 mm																													
3 grooves	2.5 mm ² AWG 14	7.5 mm																													
wide groove	3 mm ² AWG 12	7.5 mm																													
no groove	4 mm ² AWG 12	7.5 mm																													

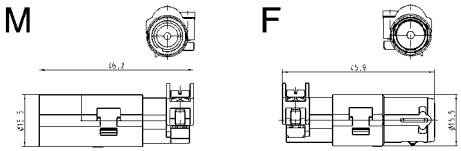
Coaxial contact, 1 + shielding, for Han E® crimp contacts, 50 Ohm  <p>Please order crimp contacts separately.</p>		09 15 001 3023	09 15 001 3123	 <table border="1"> <thead> <tr> <th>Han E® Coax with RG 213 cable (2.5 mm²)</th> <th>200 MHz</th> <th>500 MHz</th> <th>1.0 GHz</th> <th>1.2 GHz</th> <th>1.5 GHz</th> <th>2.0 GHz</th> <th>2.5 GHz</th> </tr> </thead> <tbody> <tr> <td>Return loss [dB]</td> <td>23.8</td> <td>21.1</td> <td>>18.7</td> <td>>17.7</td> <td>>16.4</td> <td>>14.1</td> <td>>12.0</td> </tr> <tr> <td>Attenuation [dB]</td> <td>0.07</td> <td>0.11</td> <td>0.17</td> <td>0.2</td> <td><0.23</td> <td><0.53</td> <td><2.0</td> </tr> </tbody> </table>	Han E® Coax with RG 213 cable (2.5 mm ²)	200 MHz	500 MHz	1.0 GHz	1.2 GHz	1.5 GHz	2.0 GHz	2.5 GHz	Return loss [dB]	23.8	21.1	>18.7	>17.7	>16.4	>14.1	>12.0	Attenuation [dB]	0.07	0.11	0.17	0.2	<0.23	<0.53	<2.0
Han E® Coax with RG 213 cable (2.5 mm ²)	200 MHz	500 MHz	1.0 GHz	1.2 GHz	1.5 GHz	2.0 GHz	2.5 GHz																					
Return loss [dB]	23.8	21.1	>18.7	>17.7	>16.4	>14.1	>12.0																					
Attenuation [dB]	0.07	0.11	0.17	0.2	<0.23	<0.53	<2.0																					

Features

- Suitable for FOC and coaxial contacts acc. to EN 41626 / D-Sub

Technical characteristics

Contacts	4, 12
Electrical data acc. to IEC 61984	50 V
Rated voltage	50 V
Rated current	1.5 A
Insulation resistance	$\geq 10^{10}$ Ohm
Limiting temperatures	-40 °C ... 125 °C
Flammability (insert) acc. to UL 94	V 0
Mating cycles	≥ 500
Material (insert)	polycarbonate
Colour (insert)	RAL 7032 (light grey)
Material (contact)	copper alloy
Insertion loss	<2.5 dB, <1.5 dB

Specifications and approvals

IEC 60664-1
IEC 61984



Details







ATTENTION! Guide pins and bushes are prescribed (see chapter 80).

Number of contacts

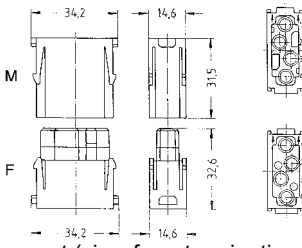
4

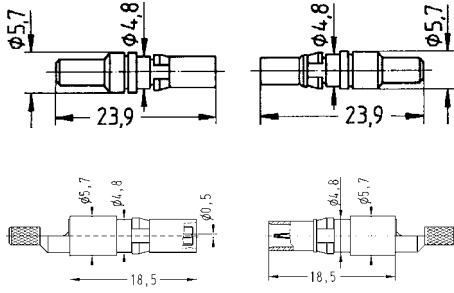
1.5 A



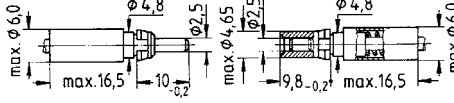

Han-Modular

Identification	Impedance	Part number		Drawing Dimensions in mm																																																											
		male	female																																																												
Han-Modular®, Han® Multi module  Please order contacts separately.		09 14 004 4501	09 14 004 4512	 Contact arrangement (view from termination side)																																																											
Coaxial contact, Solder / crimp contact, acc. to DIN 41 626, gold plated contacts, contact resistance ≤3 Ohm 	50 Ohm 75 Ohm	09 14 000 6111 09 14 000 6121	09 14 000 6211 09 14 000 6221	 <table border="1"> <thead> <tr> <th rowspan="2">Wires</th> <th>Shell</th> <th rowspan="2">Internal wire</th> <th colspan="3">Dämpfung db/100 m bei</th> </tr> <tr> <th>∅</th> <th>∅</th> <th>100MHz</th> <th>200MHz</th> <th>800MHz</th> </tr> <tr> <td></td> <td>mm</td> <td>mm</td> <td></td> <td></td> <td></td> </tr> </thead> <tbody> <tr> <td>50 Ω</td> <td></td> <td></td> <td></td> <td></td> <td></td> </tr> <tr> <td>RG 174 / U</td> <td>2.5</td> <td>0.48</td> <td></td> <td></td> <td>84</td> </tr> <tr> <td>RG 188 A / U</td> <td>2.6</td> <td>0.54</td> <td>29</td> <td>40</td> <td></td> </tr> <tr> <td>RG 316 / U</td> <td>2.5</td> <td>0.54</td> <td></td> <td>40</td> <td></td> </tr> <tr> <td>75 Ω</td> <td></td> <td></td> <td></td> <td></td> <td></td> </tr> <tr> <td>RG 179 B / U</td> <td>2.55</td> <td>0.3</td> <td></td> <td>41</td> <td></td> </tr> <tr> <td>RG 187 A / U</td> <td>2.7</td> <td>0.3</td> <td></td> <td>41</td> <td></td> </tr> </tbody> </table>	Wires	Shell	Internal wire	Dämpfung db/100 m bei			∅	∅	100MHz	200MHz	800MHz		mm	mm				50 Ω						RG 174 / U	2.5	0.48			84	RG 188 A / U	2.6	0.54	29	40		RG 316 / U	2.5	0.54		40		75 Ω						RG 179 B / U	2.55	0.3		41		RG 187 A / U	2.7	0.3		41	
Wires	Shell	Internal wire	Dämpfung db/100 m bei																																																												
	∅		∅	100MHz	200MHz	800MHz																																																									
	mm	mm																																																													
50 Ω																																																															
RG 174 / U	2.5	0.48			84																																																										
RG 188 A / U	2.6	0.54	29	40																																																											
RG 316 / U	2.5	0.54		40																																																											
75 Ω																																																															
RG 179 B / U	2.55	0.3		41																																																											
RG 187 A / U	2.7	0.3		41																																																											
F.O. contact, acc. to DIN 41 626  for 1 mm plastic fibre		20 10 001 4211	20 10 001 4221																																																												
F.O. contact, acc. to DIN 41 626  for GI fibre 50/125 µm or 62.5/125 µm ceramic ferrule		20 10 125 4212	20 10 125 4222																																																												
F.O. contact, acc. to DIN 41 626  for SI fibre (HCS®) 200/230 µm		20 10 230 4211	20 10 230 4221																																																												

Number of contacts

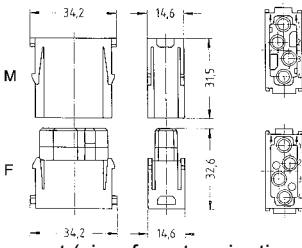
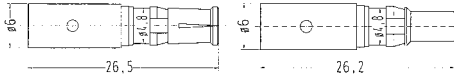
4

1.5 A

Identification	Impedance	Part number		Drawing Dimensions in mm
		male	female	
Han-Modular®, Han® Multi module  Please order contacts separately.		09 14 004 4501	09 14 004 4513	 <p>Contact arrangement (view from termination side)</p> 
Coaxial contact, Solder / solder contact, acc. to D-Sub, gold plated contacts, contact resistance ≤ 3 Ohm 	50 Ohm	09 14 000 6215	09 14 000 6115	
Solder / crimp contact, acc. to D-Sub, gold plated contacts 	50 Ohm 75 Ohm	09 69 281 5140 09 69 281 5141 09 69 281 5143 09 69 281 5230	09 69 181 5140 09 69 181 5141 09 69 181 5143 09 69 181 5230	
Crimp / crimp terminal, acc. to D-Sub, gold plated contacts 	50 Ohm 75 Ohm	09 69 282 5140 09 69 282 5230	09 69 182 5140 09 69 182 5230	









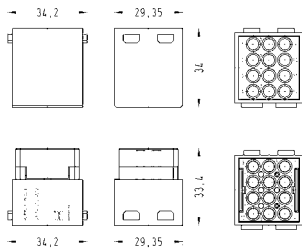

Han-Modular

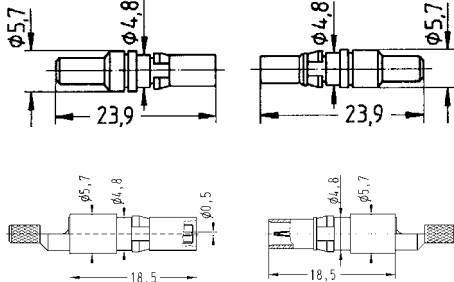
Number of contacts

12

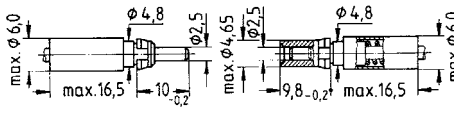
50 V
1.5 A

Han-Modular

Identification	Impedance	Part number		Drawing Dimensions in mm																																																					
		male	female																																																						
Han-Modular®, Han® Multi module, according to DIN 41 626  Please order contacts separately.		09 14 012 4501	09 14 012 4512	 Contact arrangement (view from termination side)																																																					
Coaxial contact, Solder / crimp contact, acc. to DIN 41 626, gold plated contacts, contact resistance ≤3 Ohm 	50 Ohm 75 Ohm	09 14 000 6111 09 14 000 6121	09 14 000 6211 09 14 000 6221	 <table border="1"> <thead> <tr> <th rowspan="2">Wires</th> <th>Shell</th> <th rowspan="2">Internal wire</th> <th colspan="3">Dämpfung db/100 m bei</th> </tr> <tr> <th>∅ mm</th> <th>∅ mm</th> <th>100MHz</th> <th>200MHz</th> <th>800MHz</th> </tr> </thead> <tbody> <tr> <td>50 Ω</td> <td></td> <td></td> <td></td> <td></td> <td></td> </tr> <tr> <td>RG 174 / U</td> <td>2.5</td> <td>0.48</td> <td></td> <td></td> <td>84</td> </tr> <tr> <td>RG 188 A / U</td> <td>2.6</td> <td>0.54</td> <td>29</td> <td>40</td> <td></td> </tr> <tr> <td>RG 316 / U</td> <td>2.5</td> <td>0.54</td> <td></td> <td>40</td> <td></td> </tr> <tr> <td>75 Ω</td> <td></td> <td></td> <td></td> <td></td> <td></td> </tr> <tr> <td>RG 179 B / U</td> <td>2.55</td> <td>0.3</td> <td></td> <td>41</td> <td></td> </tr> <tr> <td>RG 187 A / U</td> <td>2.7</td> <td>0.3</td> <td></td> <td>41</td> <td></td> </tr> </tbody> </table>	Wires	Shell	Internal wire	Dämpfung db/100 m bei			∅ mm	∅ mm	100MHz	200MHz	800MHz	50 Ω						RG 174 / U	2.5	0.48			84	RG 188 A / U	2.6	0.54	29	40		RG 316 / U	2.5	0.54		40		75 Ω						RG 179 B / U	2.55	0.3		41		RG 187 A / U	2.7	0.3		41	
Wires	Shell	Internal wire	Dämpfung db/100 m bei																																																						
	∅ mm		∅ mm	100MHz	200MHz	800MHz																																																			
50 Ω																																																									
RG 174 / U	2.5	0.48			84																																																				
RG 188 A / U	2.6	0.54	29	40																																																					
RG 316 / U	2.5	0.54		40																																																					
75 Ω																																																									
RG 179 B / U	2.55	0.3		41																																																					
RG 187 A / U	2.7	0.3		41																																																					
F.O. contact, acc. to DIN 41 626  for 1 mm plastic fibre F.O. contact, acc. to DIN 41 626  for GI fibre 50/125 µm or 62.5/125 µm ceramic ferrule F.O. contact, acc. to DIN 41 626  for SI fibre (HCS®) 200/230 µm		20 10 001 4211	20 10 001 4221																																																						
F.O. contact, acc. to DIN 41 626  for GI fibre 50/125 µm or 62.5/125 µm ceramic ferrule F.O. contact, acc. to DIN 41 626  for SI fibre (HCS®) 200/230 µm		20 10 125 4212	20 10 125 4222																																																						
F.O. contact, acc. to DIN 41 626  for SI fibre (HCS®) 200/230 µm		20 10 230 4211	20 10 230 4221																																																						

Features

- For the transmission of clean and dry compressed air
- Female contacts with / without shut off
- Removal of tubes from pre-assembled pneumatic contacts is possible

Technical characteristics

Contacts	2, 3
Limiting temperatures	-40 °C ... 80 °C
Flammability (insert) acc. to UL 94	V 0
Mating cycles	≥500
Material (insert)	polycarbonate
Colour (insert)	blue
Material (seal)	Buna-N
Material (contact)	delrin acetal
Operating pressure	8 bar / 116 psi

Specifications and approvals



Details

Shut off principle:

In the disconnected position the spring integrated in the female contact is active, thus the O-ring of the valve seals the opening of the air-way. During the mating process, when the defined depth of insertion is reached the male contact presses on the valve head and moves it backwards against the spring tension, so that the air-way opens.

Using of guiding pins in connection with pneumatic modules is imperative.

In addition to this guiding pins guarantee a coding, if pneumatic modules are used exclusively.

Number of contacts

2

Han-Modular

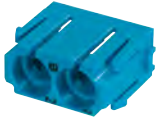
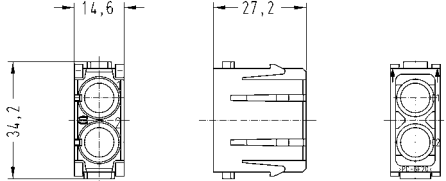
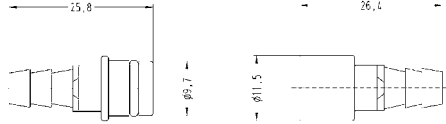
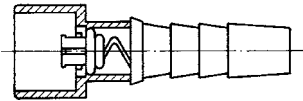
Identification	Part number		Drawing Dimensions in mm
	male	female	
Han-Modular®, Han® Pneumatic module  Please order contacts separately. Using of guiding pins is imperative!	09 14 002 4501	09 14 002 4501	 Contact arrangement (view from termination side)
Han-Modular®, Pneumatic contact, without shut off, 6.0 mm / 1/4"	09 14 000 6174	09 14 000 6274	 Male contact Female contact
Han-Modular®, Pneumatic contact, with shut off, polypropylen, 6.0 mm / 1/4"		09 14 000 6279	 female contact with shut off in closed position

Number of contacts

3

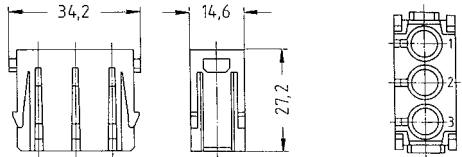
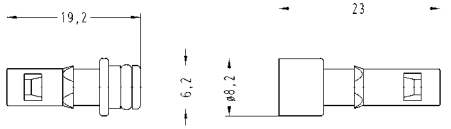
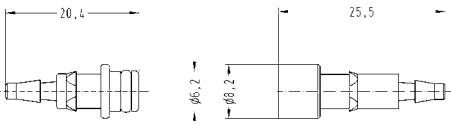
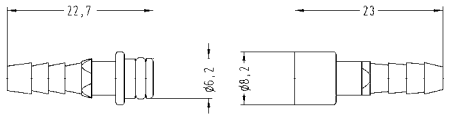
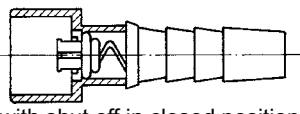
Identification	Part number		Drawing Dimensions in mm
	male	female	
Han-Modular®, Han® Pneumatic module  Please order contacts separately. Using of guiding pins is imperative!	09 14 003 4501	09 14 003 4501	 Contact arrangement (view from termination side)
Han-Modular®, Pneumatic contact, without shut off, 1.6 mm / 1/16"	09 14 000 6151	09 14 000 6251	 Male contact Female contact
Han-Modular®, Pneumatic contact, without shut off, 3.0 mm	09 14 000 6152	09 14 000 6252	
Han-Modular®, Pneumatic contact, without shut off, 4.0 mm / 1/8"	09 14 000 6153	09 14 000 6253	
Han-Modular®, Pneumatic contact, with shut off, polypropylen, 1.6 mm / 1/16"		09 14 000 6256	 female contact with shut off in closed position
Han-Modular®, Pneumatic contact, with shut off, polypropylen, 3.0 mm		09 14 000 6257	
Han-Modular®, Pneumatic contact, with shut off, polypropylen, 4.0 mm / 1/8"		09 14 000 6258	

Features

- Suitable for HARTING SC contacts
- For GI-Fibre 50 - 62,5 / 125µm

Technical characteristics

Contacts	4
Limiting temperatures	-40 °C ... 85 °C
Flammability (insert) acc. to UL 94	V 0
Mating cycles	≥500
Material (insert)	polycarbonate
Colour (insert)	RAL 7032 (light grey)
Insertion loss	<0.5 dB

Specifications and approvals



Details

Guide pins and bushes are recommended (see chapter 80).

Details

Male module

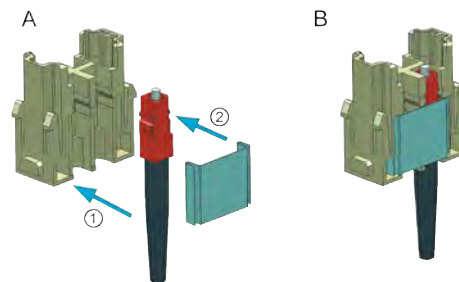

- A) Assemble the SC contact
 Push the SC contact from the side into the relevant insert ①
 Push the fixing plate from the side over the contacts ②
 B) SC contact fixed in the module



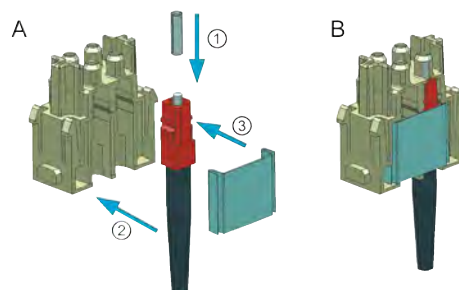

Female module

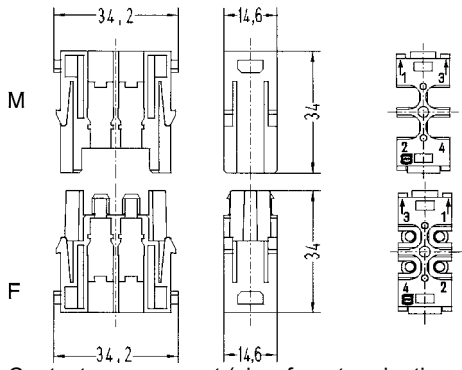

- A) Assemble the SC contact
 Push the centering ferrule (included in delivery) on the SC contact ①
 Push the SC contact from the side into the relevant insert ②
 Push the fixing plate from the side over the contacts ③
 B) SC contact fixed in the module

Number of contacts

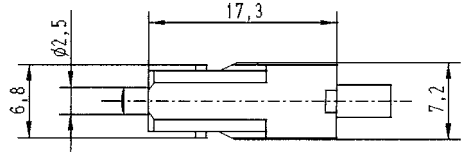
4

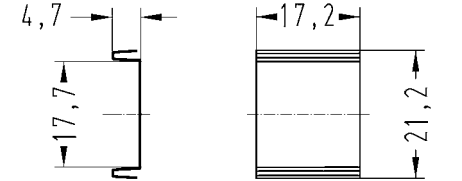
Identification	Part number		Drawing Dimensions in mm
	male	female	
<p>Han-Modular®, Han® SC module, for F.O.</p>  <p>Please order contacts separately.</p>	09 14 004 4701	09 14 004 4711	 <p>Contact arrangement (view from termination side) The female inserts are equipped with centering ferrules. 4 ferrules are included in delivery range.</p>
<p>SC contact</p>  <p>for GI fibre 50/125 µm or 62.5/125 µm ceramic ferrule</p>	20 10 125 5211	20 10 125 5211	
<p>SC contact for SI fibre (HCS®) 200/230 µm</p>	20 10 230 5211	20 10 230 5211	
<p>SC contact, with crimp technique, for 1 mm POF</p>	20 10 001 5211	20 10 001 5211	
<p>SC contact, with quick assembly, for 1 mm POF</p>	20 10 001 5217	20 10 001 5217	
<p>Han-Modular®, Fixing plate, for SC module</p> 	09 14 000 9965	09 14 000 9965	

Features

- Suitable for HARTING LC contacts
- For GI-Fibre 50 - 62.5 / 125 µm and for single mode fibre

Technical characteristics





Contacts	6
Limiting temperatures	-40 °C ... 85 °C
Flammability (insert) acc. to UL 94	V 0
Mating cycles	≥500
Material (insert)	polycarbonate
Colour (insert)	RAL 7032 (light grey)

Details

ATTENTION! Guide pins and bushes are prescribed (see chapter 80).

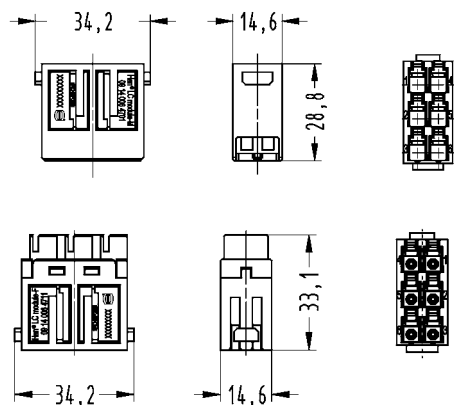
Number of contacts

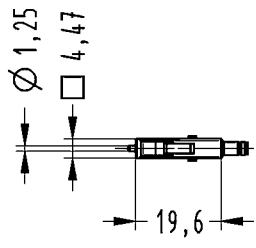
6

Identification	Part number		Drawing Dimensions in mm
	male	female	
<p>Han-Modular®, Han® LC module, for F.O.</p>  <p>Please order contacts separately.</p>	09 14 006 4701	09 14 006 4711	
<p>LC contact, for wire gauge up to 3mm max., LWL Multi Mode</p> 	20 10 125 8211	20 10 125 8211	
<p>LC contact, for wire gauge up to 2mm, LWL Multi Mode</p> 	20 10 125 8212	20 10 125 8212	
<p>LC contact, for wire gauge up to 3mm max., LWL Single Mode</p>	20 10 125 8220	20 10 125 8220	
<p>LC contact, for wire gauge up to 2mm, LWL Single Mode</p>	20 10 125 8221	20 10 125 8221	

Han-Modular

Features

- Pre-leading grounding system according VDE
- Modules can only be assembled polarized
- Alphabetical marking of module position
- High mechanical reliability of modules in case of vibration and impact stress
- No tools necessary to remove modules
- Hinged frames can be used either in hood or housing

Technical characteristics

Limiting temperatures	-40 °C ... 125 °C
Mating cycles	≥500
Mating cycles with HMC connectors	≥10000
Material (hoods/housings)	zinc die-cast

Specifications and approvals

IEC 60664-1
IEC 61984



Details

Both different markings must be used for one connector!

Locking element 09 14 000 9960 see accessories in chapter 06

Wire gauge PE (power side) 4 ... 10 mm²

10 mm² only with ferrule crimp tool 09 99 000 0374 (see chapter 90)

Wire gauge PE (signal side) 1 ... 2.5 mm²



Identification	Part number	Drawing Dimensions in mm
Han-Modular®, Hinged frame, for 2 modules, A ... B	09 14 006 0303	<p>1) Distance max. 20.5 mm</p>
Han-Modular®, Hinged frame, for 2 modules, a ... b	09 14 006 0313	
Han-Modular®, Hinged frame HMC, for 2 modules, A ... B	09 14 206 0303	<p>1) Distance max. 20.5 mm</p>
Only with Han® Docking frame.		
Han-Modular®, Hinged frame HMC, for 2 modules, a ... b	09 14 206 0313	
Only with Han® Docking frame.		



Han-Modular

Identification

Part number

Drawing
Dimensions in mm

Han-Modular®,
Hinged frame,
for 3 modules,
A ... C

09 14 010 0303

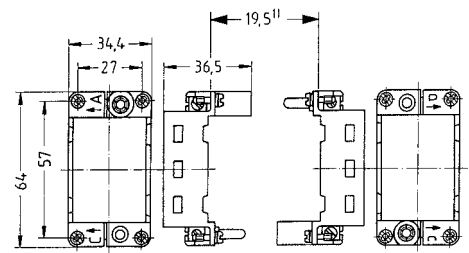

Han-Modular®,
Hinged frame,
for 3 modules,
a ... c

09 14 010 0313



Han-Modular®,
Hinged frame HMC,
for 3 modules,
A ... C

09 14 210 0303

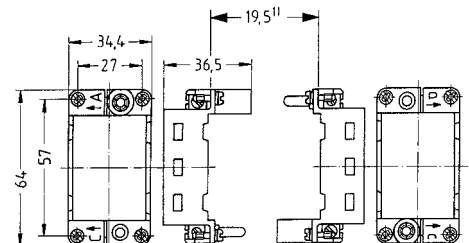

Han-Modular®,
Hinged frame HMC,
for 3 modules,
a ... c

09 14 210 0313





Identification	Part number	Drawing Dimensions in mm
Han-Modular®, Hinged frame, for 4 modules, A ... D	09 14 016 0303	<p>1) Distance max. 20.5 mm</p>
Han-Modular®, Hinged frame, for 4 modules, a ... d	09 14 016 0313	<p>1) Distance max. 20.5 mm</p>
Han-Modular®, Hinged frame HMC, for 4 modules, A ... D	09 14 216 0303	<p>1) Distance max. 20.5 mm</p>
Han-Modular®, Hinged frame HMC, for 4 modules, a ... d	09 14 216 0313	<p>1) Distance max. 20.5 mm</p>



Han-Modular

Identification	Part number	Drawing Dimensions in mm
Han-Modular®, Hinged frame, for 6 modules, A ... F	09 14 024 0303	<p>1) Distance max. 20.5 mm</p>
Han-Modular®, Hinged frame, for 6 modules, a ... f	09 14 024 0313	<p>1) Distance max. 20.5 mm</p>
Han-Modular®, Hinged frame HMC, for 6 modules, A ... F	09 14 224 0303	<p>1) Distance max. 20.5 mm</p>
Han-Modular®, Hinged frame HMC, for 6 modules, a ... f	09 14 224 0313	<p>1) Distance max. 20.5 mm</p>

Features

- Blind mating connector system for drawer systems
- Direct panel mounting without housing
- Very robust design
- Solid pre-leading guide pins and float bushes
- Can be fixed with standard M4 screws
- Suitable for Han-Modular® modules

Technical characteristics

Limiting temperatures	-40 °C ... 125 °C
Flammability (hoods/housings) acc. to UL 94	V 0
Mating cycles	≥500
Mating cycles with HMC connectors	≥10000
Degree of protection acc. to IEC 60529	IP20
Material (accessories)	polycarbonate
Tolerance	±2 mm
Lock-in range	±4 mm

Specifications and approvals

IEC 60664-1
IEC 61984

Details

Due the plastic material used in the docking frame without PE, the panel will need to be grounded separately.

Han-Modular

Identification

Part number

Drawing
Dimensions in mm

Han-Modular®,
Docking frame,
float mount,
for 2 modules,
A ... B

09 14 006 1701

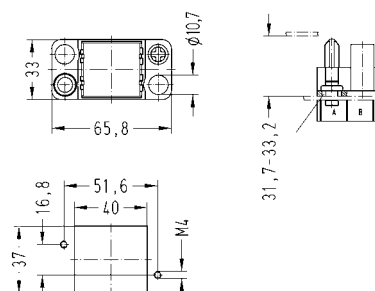

① floating tolerance ± 2 mm
Panel cut out

Han-Modular®,
Docking frame,
fixed,
for 2 modules,
a ... b

09 14 006 1711

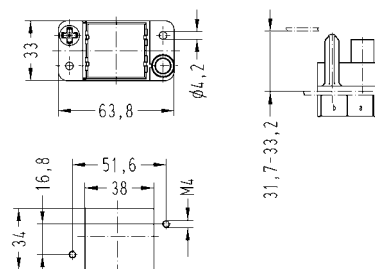

Panel cut out

Han-Modular®,
Docking frame,
float mount,
for 3 modules,
A ... C

09 14 010 1701

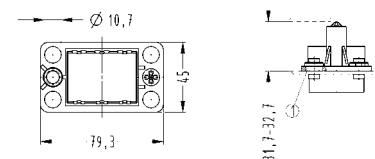

① floating tolerance ± 2 mm

Han-Modular®,
Docking frame,
fixed,
for 3 modules,
a ... c

09 14 010 1711

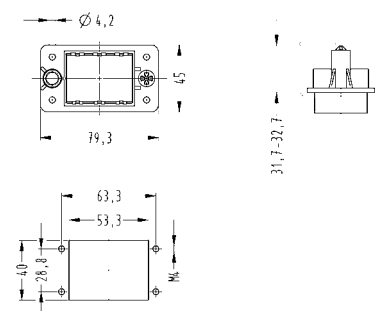

Panel cut out

Identification	Part number	Drawing Dimensions in mm
Han-Modular®, Docking frame, float mount, for 4 modules, A ... D	09 14 016 1701	<p>① floating tolerance ± 2 mm</p> <p>Panel cut out</p>
Han-Modular®, Docking frame, fixed, for 4 modules, a ... d	09 14 016 1711	<p>Panel cut out</p>
Han-Modular®, Docking frame, float mount, for 6 modules, A ... F	09 14 024 1701	<p>① floating tolerance ± 2 mm</p> <p>Panel cut out</p>
Han-Modular®, Docking frame, fixed, for 6 modules, a ... f	09 14 024 1711	<p>Panel cut out</p>

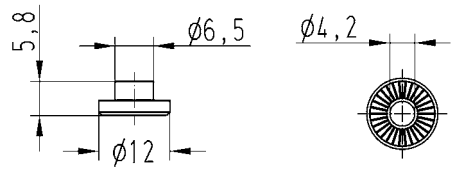
Identification	Part number	Drawing Dimensions in mm
<p data-bbox="89 318 247 398">Han-Modular®, Float washer, zinc die-cast</p>  <p data-bbox="89 555 750 611">to enable the frame to be float mounted using standard M4 fixing screws</p>	<p data-bbox="774 318 949 347">09 14 000 9936</p>	

Han-Modular

Features

- Robust housing
- Compact design saves space
- Modular structure increases flexibility
- Simple and quick assembly
- Two-part housing

Derating

Current carrying capacity

The current carrying capacity of the connectors is limited by the thermal load capability of the contact element material including the connections and the insulating parts. The derating curve is therefore valid for currents which flow constantly (non-intermittent) through each contact element of the connector evenly, without exceeding the allowed maximum temperature.

Measuring and testing techniques acc. to IEC 60512-5-2

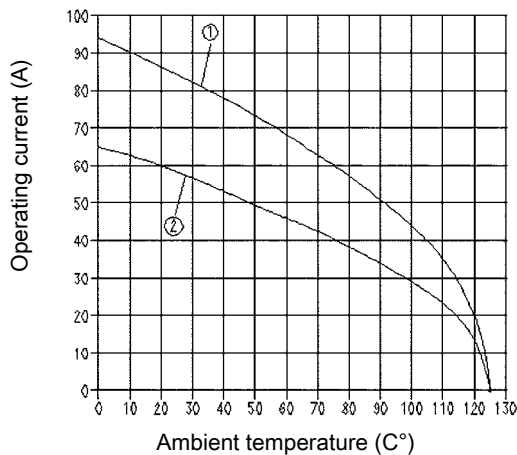

- ① Han® 40 A Axial module Wire cross section 10 mm²
- ② Han® C module Wire cross section 6 mm²

Technical characteristics

Limiting temperatures	-40 °C ... 125 °C
Flammability (hoods/housings) acc. to UL 94	V 0
Mating cycles	≥500
Tightening torque	1 Nm
Degree of protection acc. to IEC 60529	IP65 in locked position
Material (hoods/housings)	zinc die-cast
Surface (hoods/housings)	nickel plated
Material (locking lever)	stainless steel
Material (seal)	NBR
Material (screwing)	stainless steel



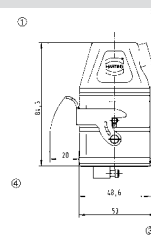



Details



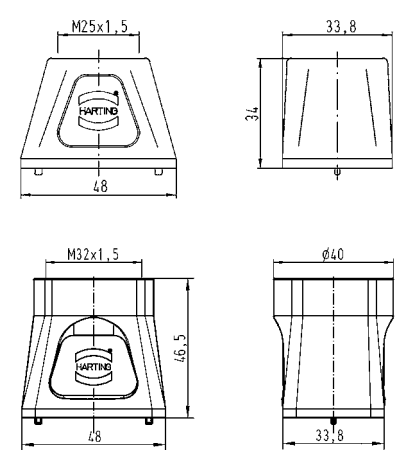

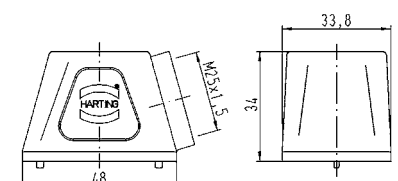

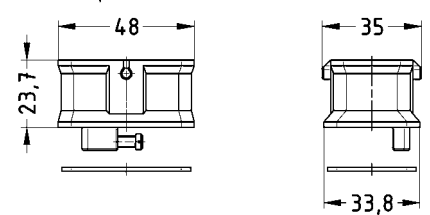
- ① Hood with side entry
- ② Cable entry M25
- ③ Bulkhead mounted housing with locking lever
- ④ Carrier hood

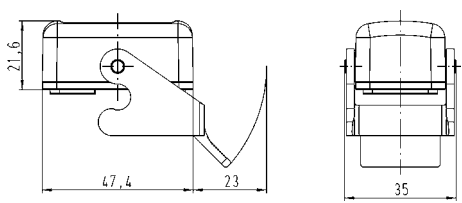

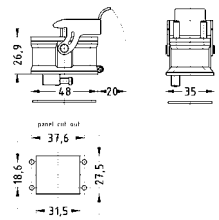
Han-Modular

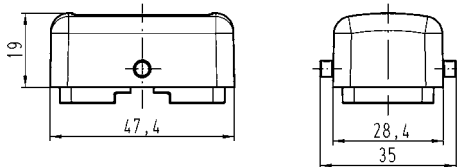
Identification	Cable entry	Part number	Drawing Dimensions in mm
<p>Han-Modular® Compact, Hoods, top entry</p> <p>Range of delivery: 4 screws are included in the delivery range</p> 	<p>1xM25 1xM32</p>	<p>19 14 001 0401 19 14 001 0402</p>	
<p>Han-Modular® Compact, Hoods, side entry</p> <p>Range of delivery: 4 screws are included in the delivery range</p> 	<p>1xM25</p>	<p>19 14 001 0501</p>	
<p>Han-Modular® Compact, Carrier hood</p> 		<p>09 14 001 0311</p>	 <p>Wire cross section PE contact 10 mm² Stripping length 10 mm Tightening torque 1 Nm</p>
<p>Han-Modular® Compact, Protection covers for carrier hoods, plastic</p> 		<p>09 14 001 5402</p>	

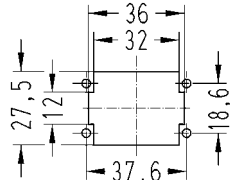
Identification	Part number	Drawing Dimensions in mm
Han-Modular® Compact, Bulkhead mounted housings 	09 14 001 0301	 <p>Wire cross section PE contact 10 mm² Stripping length 10 mm Tightening torque 1 Nm</p>
Han-Modular® Compact, Protection cover for bulkhead mounted housings, plastic 	09 14 001 5401	
Han-Modular® Compact, Fixing bracket 	09 14 000 9947	<p>Panel cut out</p> 

Han-Modular

Identification	Part number	Drawing Dimensions in mm
Coding element, 1 (red)	09 14 000 9971	
Coding element, 2 (blue)	09 14 000 9972	
Coding element, 3 (black)	09 14 000 9973	
Coding element, 4 (yellow)	09 14 000 9974	

Features

- Robust housing
- Compact design saves space
- Modular structure increases flexibility
- Simple and quick assembly
- Two-part housing

Technical characteristics

Limiting temperatures	-40 °C ... 125 °C
Mating cycles	≥500
Tightening torque	1 Nm
Degree of protection acc. to IEC 60529	IP65
Material (hoods/housings)	aluminium
Surface (hoods/housings)	powder-coated
Colour (hoods/housings)	RAL 7037 (grey)
Material (locking lever)	polycarbonate + stainless steel
Colour (locking lever)	RAL 7037 (grey)
Material (seal)	NBR



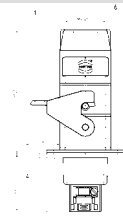



Details

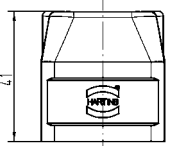
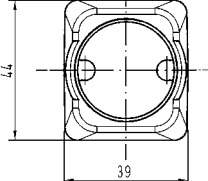

- ① Hood with top entry
- ② Carrier hood
- ③ Bulkhead mounted housing with locking lever
- ④ Switch board panel
- ⑤ Panel feed through housings
- ⑥ Cable entry

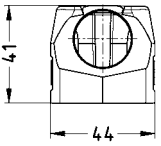
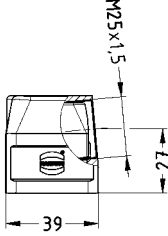

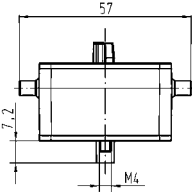
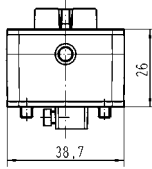
Han-Modular

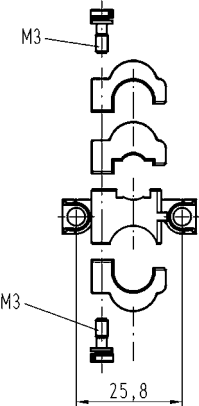
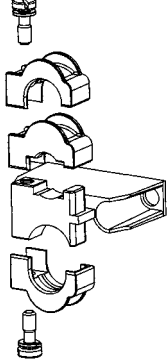
Identification		Cable entry	Part number	Drawing Dimensions in mm	
Han-Modular® Twin, Hoods, top entry, screw locking		1xM20 1xM25 1xM32	19 14 002 0400 19 14 002 0401 19 14 002 0402		
Han-Modular® Twin, Hoods, side entry, screw locking		1xM25	19 14 002 0501		
Han-Modular® Twin, Carrier hood, Han-Easy Lock®			09 14 002 0311		
Han-Modular® Twin, shielded frame, zinc die-cast			09 14 000 9924		

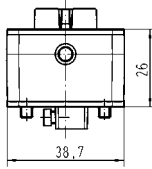
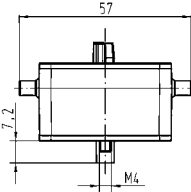
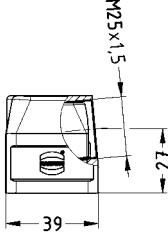
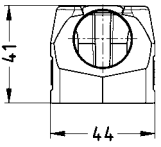
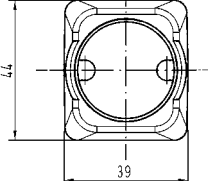
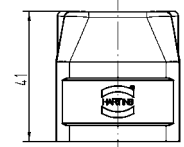

Wire cross section PE contact 10 mm²
Stripping length 10 mm
Tightening torque 1 Nm

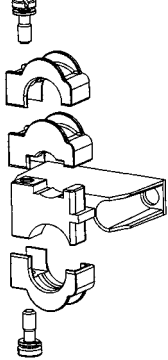
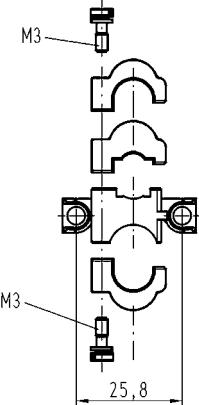

double locking lever



Identification

Part number

Drawing
Dimensions in mm

Han-Modular® Twin,
Bulkhead mounted housings,
Han-Easy Lock®

09 14 002 0301

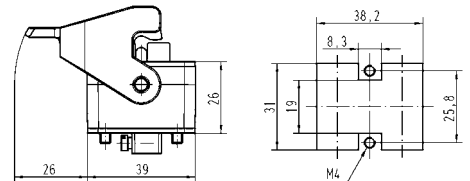

Wire cross section PE contact 10 mm²
Stripping length 10 mm
Tightening torque 1 Nm

Han-Modular® Twin,
Protection cover for bulkhead mounted housings,
metal,
closed

09 14 002 5401

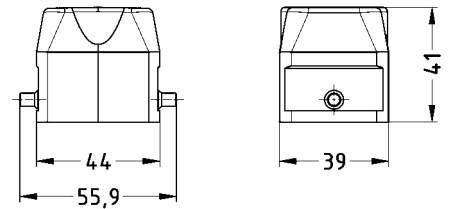

Han-Modular® Twin,
Panel feed through housings,
zinc die-cast,
screw locking

09 14 000 9928

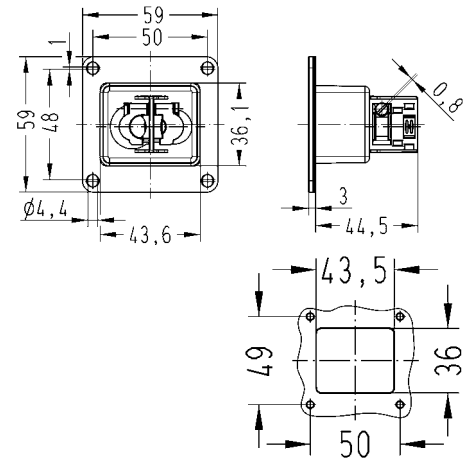

Panel cut out

Han-Modular

Features

- Suitable for all Han-Modular® single modules
- The variant with PE connection uses pin 1 of the module as PE
- Slim, space saving design
- Low cost plastic hoods and housings

Technical characteristics

Limiting temperatures	-40 °C ... 85 °C
Flammability (hoods/housings) acc. to UL 94	V 0
Mating cycles	≥500
Degree of protection acc. to IEC 60529	IP20, IP65
Material (hoods/housings)	polycarbonate
Colour (hoods/housings)	RAL 7037 (grey)
Material (seal)	NBR





Specifications and approvals



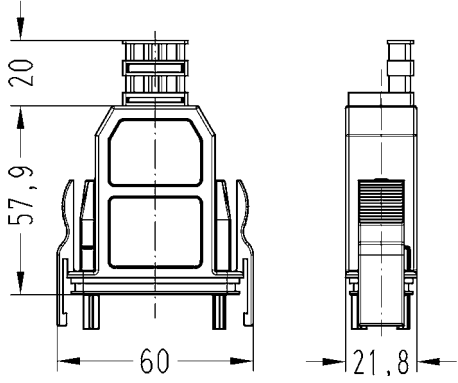

IEC 60664-1
IEC 61984

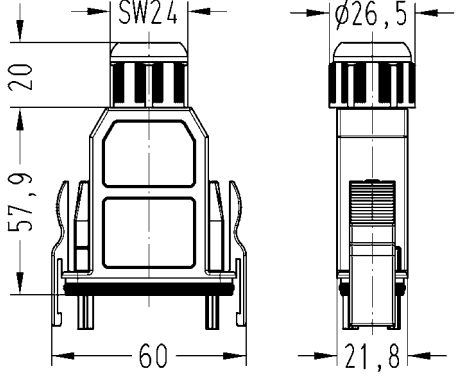
Identification	Clamping range (mm)	Part number	Drawing Dimensions in mm
Han-Modular® ECO, Hoods, IP20, top entry, Han-Snap® locking, without PE	... 14.65	09 14 001 0422	
Han-Modular® ECO, Hoods, IP65, top entry, Han-Snap® locking, without PE	6 ... 13	09 14 001 0420	
Han-Modular® ECO, Bulkhead mounted housings, top entry, Han-Snap® locking, without PE		09 14 001 0320	<p>Panel cut out</p>

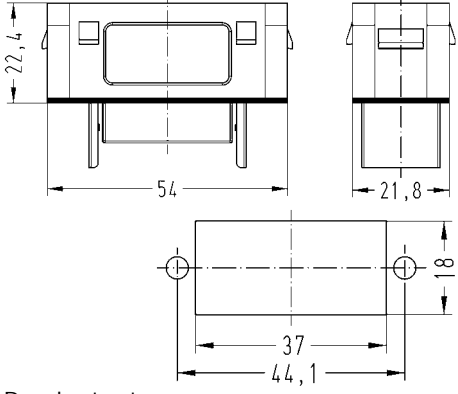

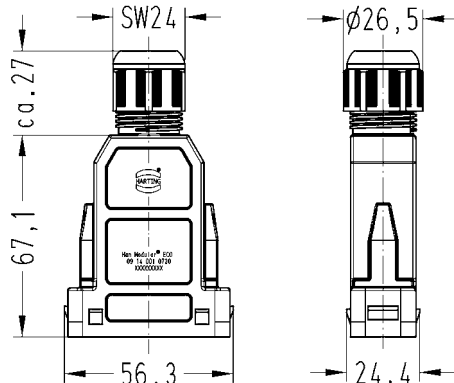

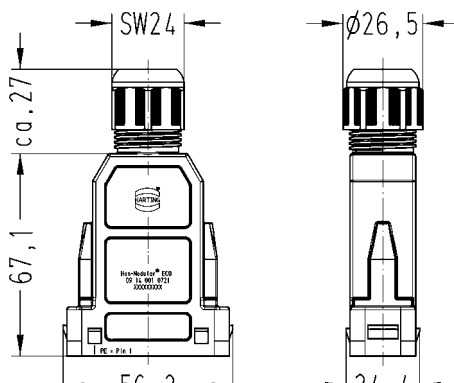

Identification	Clamping range (mm)	Part number	Drawing Dimensions in mm
Han-Modular® ECO, Cable to cable housings, IP20, top entry, Han-Snap® locking, without PE	... 14.65	09 14 001 0722	
Han-Modular® ECO, Cable to cable housings, IP65, top entry, Han-Snap® locking, without PE	6 ... 13	09 14 001 0720	
Han-Modular®, Coding element Range of delivery: 8 pieces per frame		09 14 000 9929	

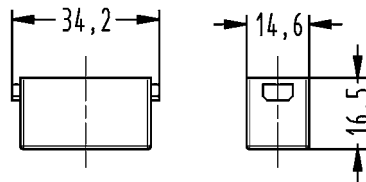

Han-Modular

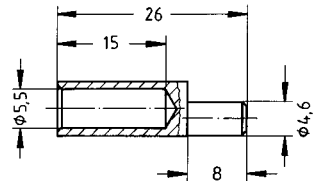
Identification	Clamping range (mm)	Part number	Drawing Dimensions in mm
<p>Han-Modular® ECO, Hoods, IP20, top entry, Han-Snap® locking, with PE marking (pin 1 = PE)</p> 	<p>... 14.65</p>	<p>09 14 001 0423</p>	
<p>Han-Modular® ECO, Hoods, IP65, top entry, Han-Snap® locking, with PE marking (pin 1 = PE)</p> 	<p>6 ... 13</p>	<p>09 14 001 0421</p>	
<p>Han-Modular® ECO, Bulkhead mounted housings, top entry, Han-Snap® locking, with PE marking (pin 1 = PE)</p> 		<p>09 14 001 0321</p>	 <p>Panel cut out</p>

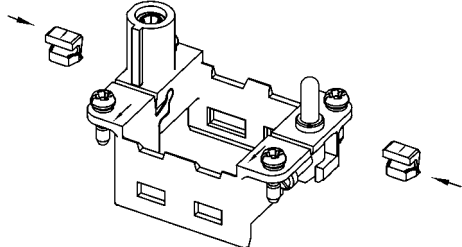
Identification	Clamping range (mm)	Part number	Drawing Dimensions in mm
<p>Han-Modular® ECO, Cable to cable housings, IP20, top entry, Han-Snap® locking, with PE marking (pin 1 = PE)</p> 	<p>... 14.65</p>	<p>09 14 001 0723</p>	
<p>Han-Modular® ECO, Cable to cable housings, IP65, top entry, Han-Snap® locking, with PE marking (pin 1 = PE)</p> 	<p>6 ... 13</p>	<p>09 14 001 0721</p>	
<p>Han-Modular®, Coding element Range of delivery: 8 pieces per frame</p> 		<p>09 14 000 9929</p>	

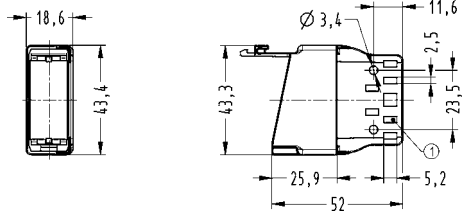
Han-Modular

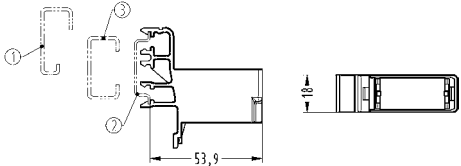
Identification	Wire cross section (mm ²)	Part number	Drawing Dimensions in mm
Han-Modular®, Han® Dummy module 		09 14 000 9950	
Han-Modular®, Cable shoe, for PE extension for hoods/housings high construction only 	16	09 14 000 9912	 <p>Please use pressing tools for non-insulated cable shoes</p>
Han-Modular®, fixing, for Han-Modular® hinged frames Range of delivery: 20 pieces per frame 		09 14 000 9960	 <p>Ideal to pre-assemble the hinged frames</p>
Han-Modular®, Module locking, with strain relief Range of delivery: 1 Module clamp 		09 14 000 0312	 <p>① For cable ties with max. 5 mm width</p>

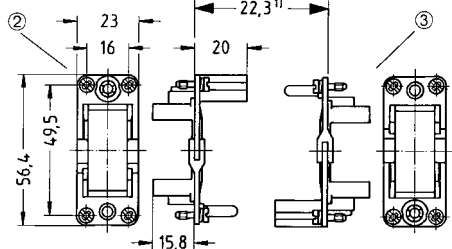
Identification	Wire cross section (mm ²)	Part number	Drawing Dimensions in mm
<p>Han-Modular®, Module locking, for rail</p> <p>Range of delivery: 1 Module clamp</p> 		09 14 000 0313	 <p>① G-rail IEC 60715-G32 ② rail IEC 60715-35 x 7.5 with 1 mm thickness or -35 x 15 with 1.5 mm thickness ③ C-rail IEC 60715-C30</p>
<p>Han-Modular®, Frame, for 1 module, in housing Han® 10 A</p> 		09 14 000 0304	 <p>1 distance max. 23.5 mm 2 hoods 3 housings</p>

Han-Modular