

## 100V, 3A/4A Peak, High Frequency Half-Bridge Drivers

The ISL2110, ISL2111 are 100V, high frequency, half-bridge N-Channel power MOSFET driver ICs. They are based on the popular HIP2100, HIP2101 half-bridge drivers, but offer several performance improvements. Peak output pull-up/pull-down current has been increased to 3A/4A, which significantly reduces switching power losses and eliminates the need for external totem-pole buffers in many applications. Also, the low end of the  $V_{DD}$  operational supply range has been extended to 8VDC. The ISL2110 has additional input hysteresis for superior operation in noisy environments and the inputs of the ISL2111, like those of the ISL2110, can now safely swing to the  $V_{DD}$  supply rail.

### Ordering Information

PART NUMBER (Notes 1, 2)	PART MARKING	TEMP RANGE (°C)	PACKAGE (Pb-Free)	PKG. DWG. #
ISL2110ABZ	2110 ABZ	-40 to +125	8 Ld SOIC	M8.15
ISL2110AR4Z	211 0AR4Z	-40 to +125	12 Ld 4x4 DFN	L12.4x4A
ISL2111ABZ	2111 ABZ	-40 to +125	8 Ld SOIC	M8.15
ISL2111AR4Z	211 1AR4Z	-40 to +125	12 Ld 4x4 DFN	L12.4x4A
ISL2111ARTZ	211 1ARTZ	-40 to +125	10 Ld 4x4 TDFN	L10.4x4
ISL2111BR4Z	211 1BR4A	-40 to +125	8 Ld 4x4 DFN	L8.4x4

#### NOTES:

1. Add "-T\*" suffix for tape and reel. Please refer to [TB347](#) for details on reel specifications.
2. These Intersil Pb-free plastic packaged products employ special Pb-free material sets, molding compounds/die attach materials, and 100% matte tin plate plus anneal (e3 termination finish, which is RoHS compliant and compatible with both SnPb and Pb-free soldering operations). Intersil Pb-free products are MSL classified at Pb-free peak reflow temperatures that meet or exceed the Pb-free requirements of IPC/JEDEC J STD-020.
3. For Moisture Sensitivity Level (MSL), please see device information page for [ISL2110](#), [ISL2111](#). For more information on MSL please see techbrief [TB363](#).

### Features

- Drives N-Channel MOSFET Half-Bridge
- SOIC, DFN and TDFN Package Options
- SOIC, DFN and TDFN Packages Compliant with 100V Conductor Spacing Guidelines per IPC-2221
- Pb-Free (RoHS Compliant)
- Bootstrap Supply Max Voltage to 114VDC
- On-Chip 1W Bootstrap Diode
- Fast Propagation Times for Multi-MHz Circuits
- Drives 1nF Load with Typical Rise/Fall Times of 9ns/7.5ns
- CMOS Compatible Input Thresholds (ISL2110)
- 3.3V/TTL Compatible Input Thresholds (ISL2111)
- Independent Inputs Provide Flexibility
- No Start-Up Problems
- Outputs Unaffected by Supply Glitches, HS Ringing Below Ground or HS Slewing at High dv/dt
- Low Power Consumption
- Wide Supply Voltage Range (8V to 14V)
- Supply Undervoltage Protection
- 1.6W/1W Typical Output Pull-Up/Pull-Down Resistance

### Applications

- Telecom Half-Bridge DC/DC Converters
- Telecom Full-Bridge DC/DC Converters
- Two-Switch Forward Converters
- Active-Clamp Forward Converters
- Class-D Audio Amplifiers

Pinouts

ISL2111ARTZ  
(10 LD 4x4 TDFN)  
TOP VIEW

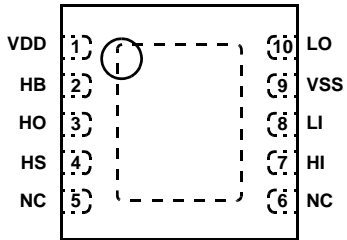

ISL2110AR4Z, ISL2111AR4Z  
(12 LD 4x4 DFN)  
TOP VIEW

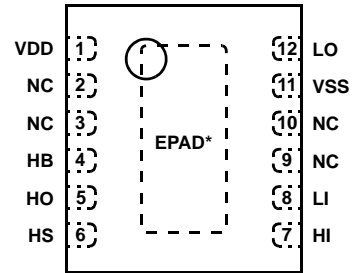

\*EPAD = Exposed PAD

ISL2110ABZ, ISL2111ABZ  
(8 LD SOIC)  
TOP VIEW

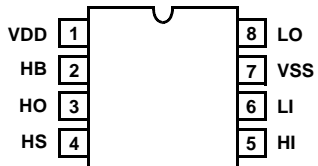

ISL2111BR4Z  
(8 LD 4x4 DFN)  
TOP VIEW

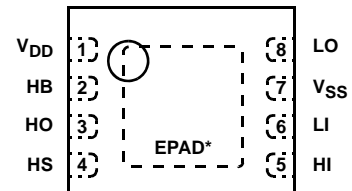

\*EPAD = EXPOSED PAD

Application Block Diagram

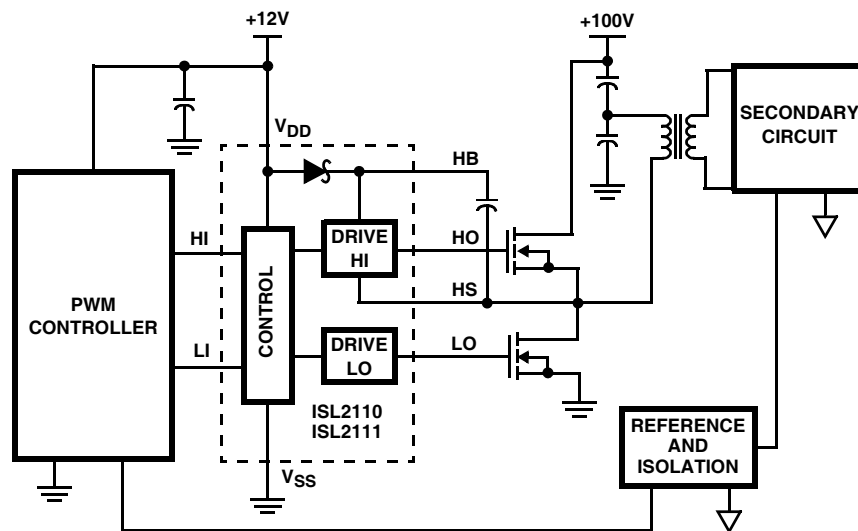

Functional Block Diagram

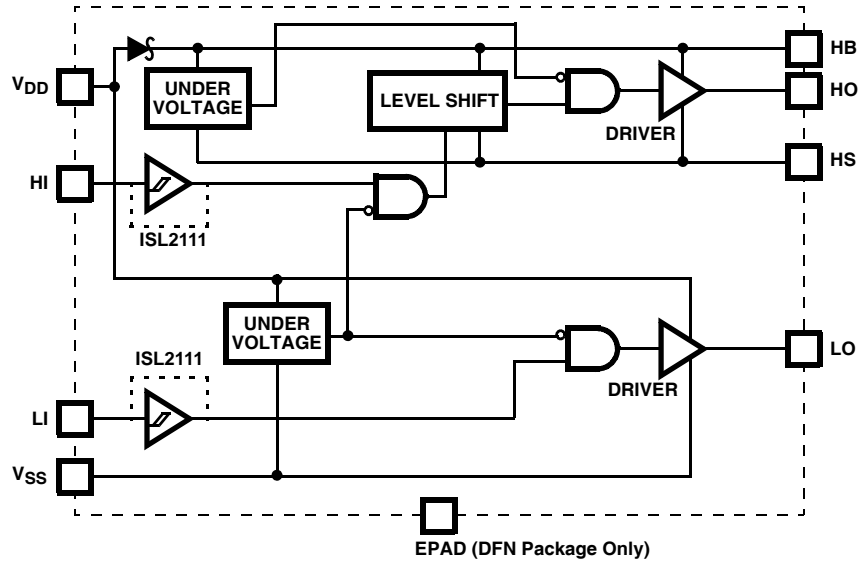

\*EPAD = Exposed Pad. The EPAD is electrically isolated from all other pins. For best thermal performance connect the EPAD to the PCB power ground plane.

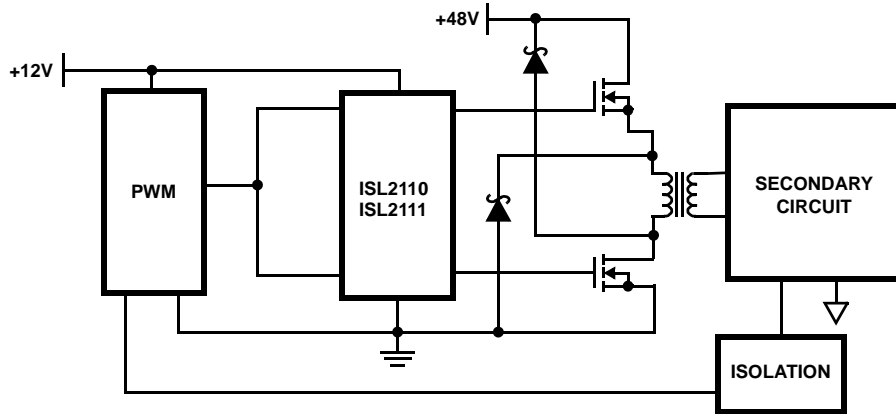

FIGURE 1. TWO-SWITCH FORWARD CONVERTER

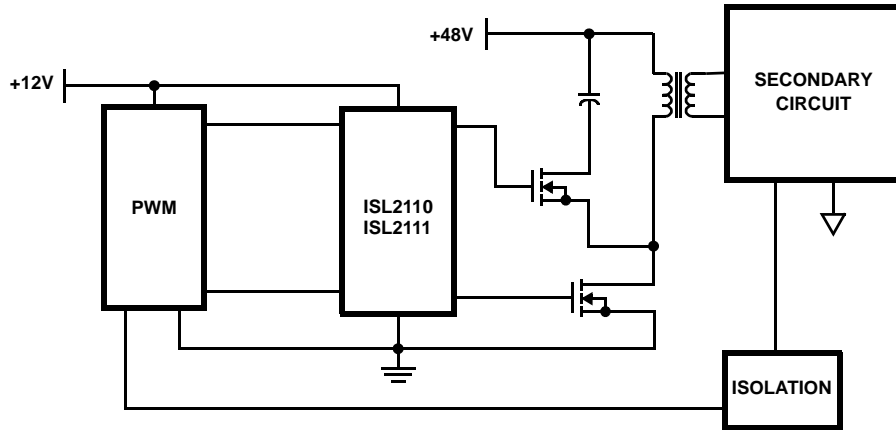

FIGURE 2. FORWARD CONVERTER WITH AN ACTIVE-CLAMP

**Absolute Maximum Ratings**

Supply Voltage,  $V_{DD}$ ,  $V_{HB} - V_{HS}$  (Notes 4, 5) . . . . . -0.3V to 18V  
 LI and HI Voltages (Note 5) . . . . . -0.3V to  $V_{DD} + 0.3V$   
 Voltage on LO (Note 5) . . . . . -0.3V to  $V_{DD} + 0.3V$   
 Voltage on HO (Note 5) . . . . .  $V_{HS} - 0.3V$  to  $V_{HB} + 0.3V$   
 Voltage on HS (Continuous) (Note 5) . . . . . -1V to 110V  
 Voltage on HB (Note 5) . . . . . 118V  
 Average Current in  $V_{DD}$  to HB Diode . . . . . 100mA

**Maximum Recommended Operating Conditions**

Supply Voltage,  $V_{DD}$  . . . . . 8V to 14V  
 Voltage on HS . . . . . -1V to 100V  
 Voltage on HS . . . . . (Repetitive Transient) -5V to 105V  
 Voltage on HB . . . . .  $V_{HS} + 7V$  to  $V_{HS} + 14V$  and  $V_{DD} - 1V$  to  $V_{DD} + 100V$   
 HS Slew Rate. . . . . <50V/ns

**Thermal Information**

Thermal Resistance (Typical)	$\theta_{JA}$ (°C/W)	$\theta_{JC}$ (°C/W)
8 Ld SOIC (Notes 6, 10) . . . . .	95	46
10 Ld TDFN (Notes 7, 8) . . . . .	42	5.5
12 Ld DFN (Notes 7, 8) . . . . .	40	5.5
8 Ld DFN (Notes 7, 8) . . . . .	40	4.0

Max Power Dissipation at +25°C in Free Air

8 Ld SOIC (Notes 6, 10) . . . . .	1.3W
10 Ld TDFN (Notes 7, 8) . . . . .	3.0W
12 Ld DFN (Notes 7, 8) . . . . .	3.1W
8 Ld DFN (Notes 7, 8) . . . . .	3.1W

Storage Temperature Range . . . . . -65°C to +150°C  
 Junction Temperature Range. . . . . -55°C to +150°C  
 Pb-free reflow profile . . . . . see link below  
<http://www.intersil.com/pbfree/Pb-FreeReflow.asp>

*CAUTION: Do not operate at or near the maximum ratings listed for extended periods of time. Exposure to such conditions may adversely impact product reliability and result in failures not covered by warranty.*

**NOTES:**

- The ISL2110 and ISL2111 are capable of derated operation at supply voltages exceeding 14V. Figure 22 shows the high-side voltage derating curve for this mode of operation.
- All voltages referenced to  $V_{SS}$  unless otherwise specified.
- $\theta_{JA}$  is measured in free air with the component mounted on a high effective thermal conductivity test board. See Tech Brief [TB379](#) for details.
- $\theta_{JA}$  is measured in free air with the component mounted on a high effective thermal conductivity test board with "direct attach" features. See Tech Brief [TB379](#).
- For  $\theta_{JC}$ , the "case temp" location is the center of the exposed metal pad on the package underside.
- Parameters with MIN and/or MAX limits are 100% tested at +25°C, unless otherwise specified. Temperature limits established by characterization and are not production tested.
- For  $\theta_{JC}$ , the "case temp" location is taken at the package top center.

**Electrical Specifications**  $V_{DD} = V_{HB} = 12V$ ,  $V_{SS} = V_{HS} = 0V$ , No Load on LO or HO, unless otherwise specified.

PARAMETERS	SYMBOL	TEST CONDITIONS	$T_J = +25^\circ C$			$T_J = -40^\circ C$ to $+125^\circ C$		UNITS
			MIN	TYP	MAX	MIN (Note 9)	MAX (Note 9)	
<b>SUPPLY CURRENTS</b>								
$V_{DD}$ Quiescent Current	$I_{DD}$	ISL2110; LI = HI = 0V	-	0.1	0.25	-	0.3	mA
$V_{DD}$ Quiescent Current	$I_{DD}$	ISL2111; LI = HI = 0V	-	0.3	0.45	-	0.55	mA
$V_{DD}$ Operating Current	$I_{DDO}$	ISL2110; f = 500kHz	-	3.4	5.0	-	5.5	mA
$V_{DD}$ Operating Current	$I_{DDO}$	ISL2111; f = 500kHz	-	3.5	5.0	-	5.5	mA
Total HB Quiescent Current	$I_{HB}$	LI = HI = 0V	-	0.1	0.15	-	0.2	mA
Total HB Operating Current	$I_{HBO}$	f = 500kHz	-	3.4	5.0	-	5.5	mA
HB to $V_{SS}$ Current, Quiescent	$I_{HBS}$	LI = HI = 0V; $V_{HB} = V_{HS} = 114V$	-	0.05	1.5	-	10	$\mu A$
HB to $V_{SS}$ Current, Operating	$I_{HBSO}$	f = 500kHz; $V_{HB} = V_{HS} = 114V$	-	1.2	-	-	-	mA
<b>INPUT PINS</b>								
Low Level Input Voltage Threshold	$V_{IL}$	ISL2110	3.7	4.4	-	3.5	-	V
Low Level Input Voltage Threshold	$V_{IL}$	ISL2111	1.4	1.8	-	1.2	-	V
High Level Input Voltage Threshold	$V_{IH}$	ISL2110	-	6.6	7.4	-	7.6	V
High Level Input Voltage Threshold	$V_{IH}$	ISL2111	-	1.8	2.2	-	2.4	V
Input Voltage Hysteresis	$V_{IHYS}$	ISL2110	-	2.2	-	-	-	V
Input Pull-Down Resistance	$R_I$		-	210	-	100	500	k $\Omega$

# ISL2110, ISL2111

## Electrical Specifications $V_{DD} = V_{HB} = 12V, V_{SS} = V_{HS} = 0V$ , No Load on LO or HO, unless otherwise specified. (Continued)

PARAMETERS	SYMBOL	TEST CONDITIONS	$T_J = +25^\circ\text{C}$			$T_J = -40^\circ\text{C to } +125^\circ\text{C}$		UNITS
			MIN	TYP	MAX	MIN (Note 9)	MAX (Note 9)	
<b>UNDERVOLTAGE PROTECTION</b>								
$V_{DD}$ Rising Threshold	$V_{DDR}$		6.1	6.6	7.1	5.8	7.4	V
$V_{DD}$ Threshold Hysteresis	$V_{DDH}$		-	0.6	-	-	-	V
HB Rising Threshold	$V_{HBR}$		5.5	6.1	6.8	5.0	7.1	V
HB Threshold Hysteresis	$V_{HBH}$		-	0.6	-	-	-	V
<b>BOOT STRAP DIODE</b>								
Low Current Forward Voltage	$V_{DL}$	$I_{VDD-HB} = 100\mu\text{A}$	-	0.5	0.6	-	0.7	V
High Current Forward Voltage	$V_{DH}$	$I_{VDD-HB} = 100\text{mA}$	-	0.7	0.9	-	1	V
Dynamic Resistance	$R_D$	$I_{VDD-HB} = 100\text{mA}$	-	0.7	1	-	1.5	$\Omega$
<b>LO GATE DRIVER</b>								
Low Level Output Voltage	$V_{OLL}$	$I_{LO} = 100\text{mA}$	-	0.1	0.18	-	0.25	V
High Level Output Voltage	$V_{OHL}$	$I_{LO} = -100\text{mA}, V_{OHL} = V_{DD} - V_{LO}$	-	0.16	0.23	-	0.3	V
Peak Pull-Up Current	$I_{OHL}$	$V_{LO} = 0V$	-	3	-	-	-	A
Peak Pull-Down Current	$I_{OLL}$	$V_{LO} = 12V$	-	4	-	-	-	A
<b>HO GATE DRIVER</b>								
Low Level Output Voltage	$V_{OLH}$	$I_{HO} = 100\text{mA}$	-	0.1	0.18	-	0.25	V
High Level Output Voltage	$V_{OHH}$	$I_{HO} = -100\text{mA}, V_{OHH} = V_{HB} - V_{HO}$	-	0.16	0.23	-	0.3	V
Peak Pull-Up Current	$I_{OHH}$	$V_{HO} = 0V$	-	3	-	-	-	A
Peak Pull-Down Current	$I_{OLH}$	$V_{HO} = 12V$	-	4	-	-	-	A

## Switching Specifications $V_{DD} = V_{HB} = 12V, V_{SS} = V_{HS} = 0V$ , No Load on LO or HO, unless otherwise specified.

PARAMETERS	SYMBOL	TEST CONDITIONS	$T_J = +25^\circ\text{C}$			$T_J = -40^\circ\text{C to } +125^\circ\text{C}$		UNITS
			MIN	TYP	MAX	MIN (Note 9)	MAX (Note 9)	
Lower Turn-Off Propagation Delay (LI Falling to LO Falling)	$t_{LPHL}$		-	32	50	-	60	ns
Upper Turn-Off Propagation Delay (HI Falling to HO Falling)	$t_{HPLH}$		-	32	50	-	60	ns
Lower Turn-On Propagation Delay (LI Rising to LO Rising)	$t_{LPLH}$		-	39	50	-	60	ns
Upper Turn-On Propagation Delay (HI Rising to HO Rising)	$t_{HPLH}$		-	38	50	-	60	ns
Delay Matching: Upper Turn-Off to Lower Turn-On	$t_{MON}$		1	8	-	-	16	ns
Delay Matching: Lower Turn-Off to Upper Turn-On	$t_{MOFF}$		1	6	-	-	16	ns
Either Output Rise Time (10% to 90%)	$t_{RC}$	$C_L = 1\text{nF}$	-	9	-	-	-	ns
Either Output Fall Time (90% to 10%)	$t_{FC}$	$C_L = 1\text{nF}$	-	7.5	-	-	-	ns
Either Output Rise Time (3V to 9V)	$t_R$	$C_L = 0.1\mu\text{F}$	-	0.3	0.4	-	0.5	$\mu\text{s}$
Either Output Fall Time (9V to 3V)	$t_F$	$C_L = 0.1\mu\text{F}$	-	0.19	0.3	-	0.4	$\mu\text{s}$
Minimum Input Pulse Width that Changes the Output	$t_{PW}$		-	-	-	-	50	ns
Bootstrap Diode Turn-On or Turn-Off Time	$t_{BS}$		-	10	-	-	-	ns

**Pin Descriptions**

SYMBOL	DESCRIPTION
V <sub>DD</sub>	Positive supply to lower gate driver. Bypass this pin to V <sub>SS</sub> .
HB	High-side bootstrap supply. External bootstrap capacitor is required. Connect positive side of bootstrap capacitor to this pin. Bootstrap diode is on-chip.
HO	High-side output. Connect to gate of high-side power MOSFET.
HS	High-side source connection. Connect to source of high-side power MOSFET. Connect negative side of bootstrap capacitor to this pin.
HI	High-side input.
LI	Low-side input.
V <sub>SS</sub>	Chip negative supply, which will generally be ground.
LO	Low-side output. Connect to gate of low-side power MOSFET.
NC	No Connect.
EPAD	Exposed pad. Connect to ground or float. The EPAD is electrically isolated from all other pins.

**Timing Diagrams**

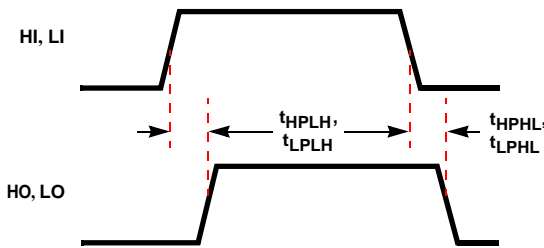

FIGURE 3. PROPAGATION DELAYS

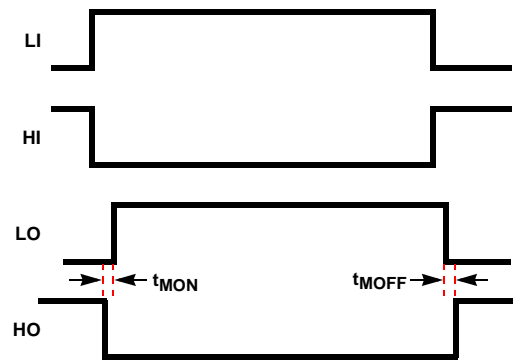

FIGURE 4. DELAY MATCHING

**Typical Performance Curves**

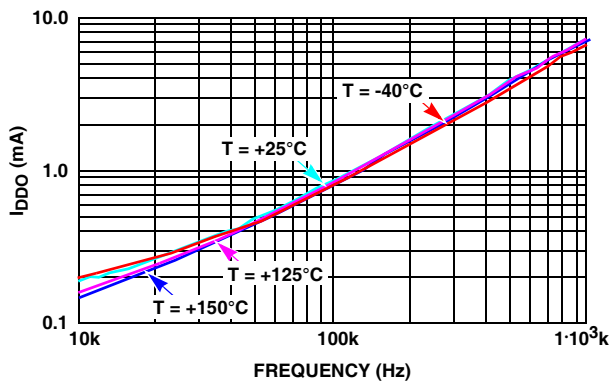

FIGURE 5. ISL2110 I<sub>DD</sub> OPERATING CURRENT vs FREQUENCY

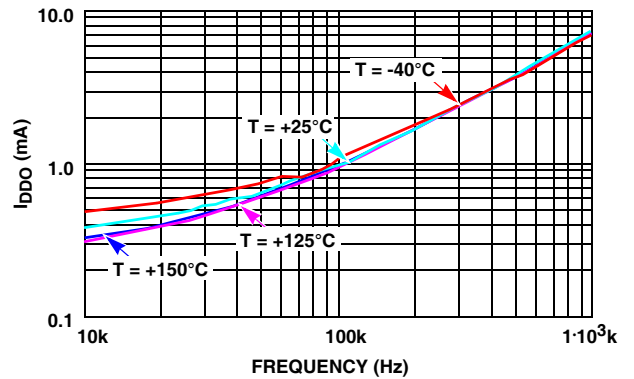

FIGURE 6. ISL2111 I<sub>DD</sub> OPERATING CURRENT vs FREQUENCY

Typical Performance Curves (Continued)

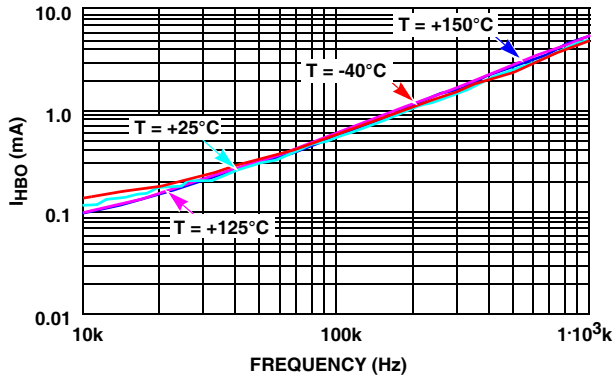

FIGURE 7.  $I_{HB}$  OPERATING CURRENT vs FREQUENCY

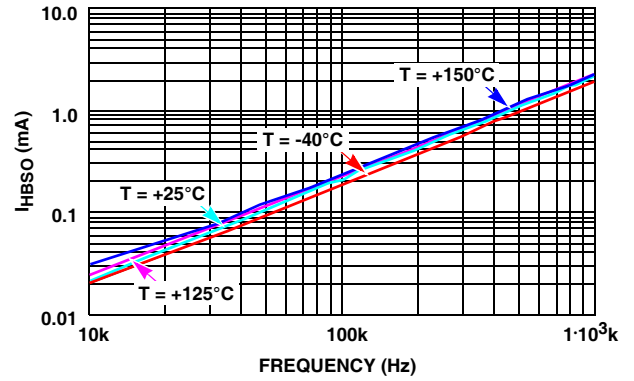

FIGURE 8.  $I_{HBS}$  OPERATING CURRENT vs FREQUENCY

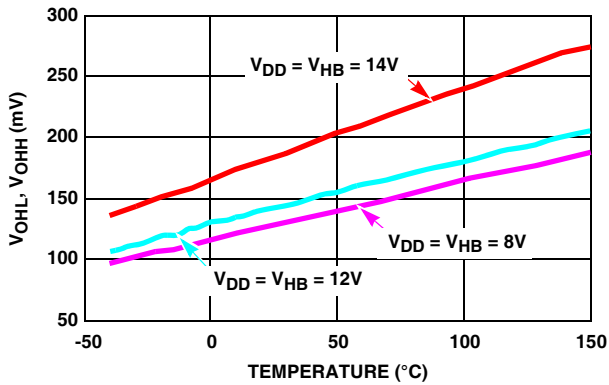

FIGURE 9. HIGH LEVEL OUTPUT VOLTAGE vs TEMPERATURE

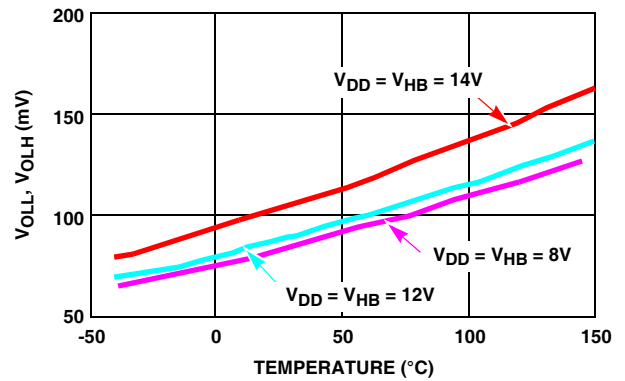

FIGURE 10. LOW LEVEL OUTPUT VOLTAGE vs TEMPERATURE

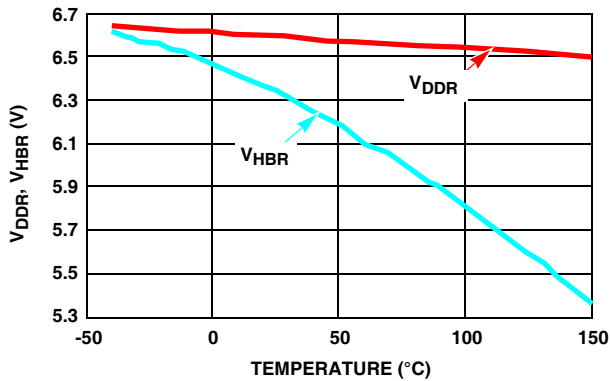

FIGURE 11. UNDERVOLTAGE LOCKOUT THRESHOLD vs TEMPERATURE

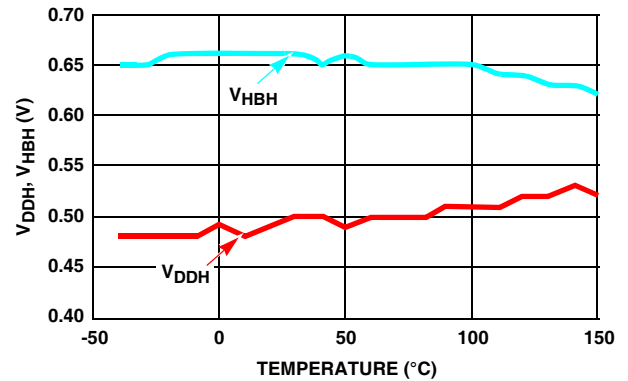

FIGURE 12. UNDERVOLTAGE LOCKOUT HYSTERESIS vs TEMPERATURE

Typical Performance Curves (Continued)

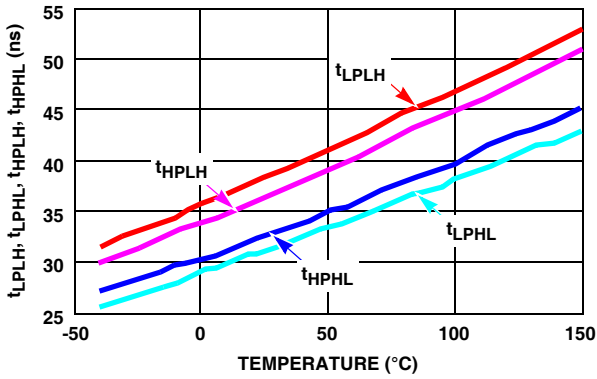

FIGURE 13. ISL2110 PROPAGATION DELAYS vs TEMPERATURE

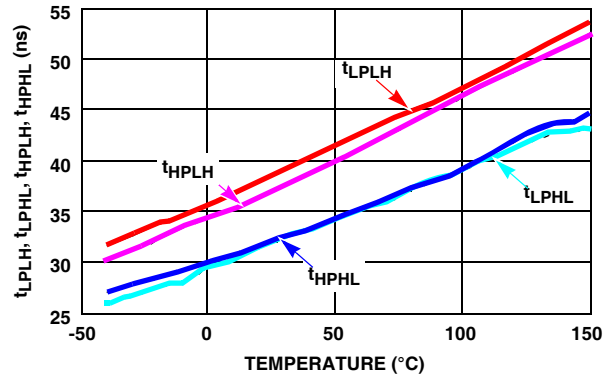

FIGURE 14. ISL2111 PROPAGATION DELAYS vs TEMPERATURE

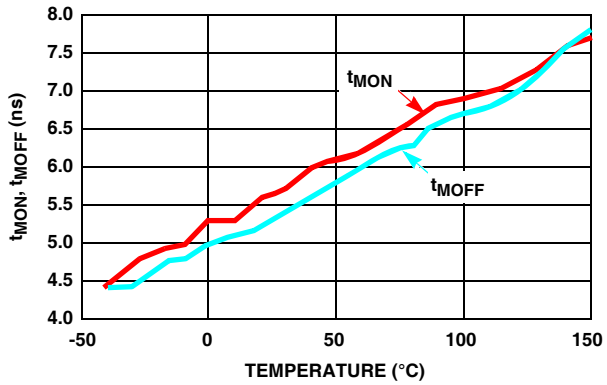

FIGURE 15. ISL2110 DELAY MATCHING vs TEMPERATURE

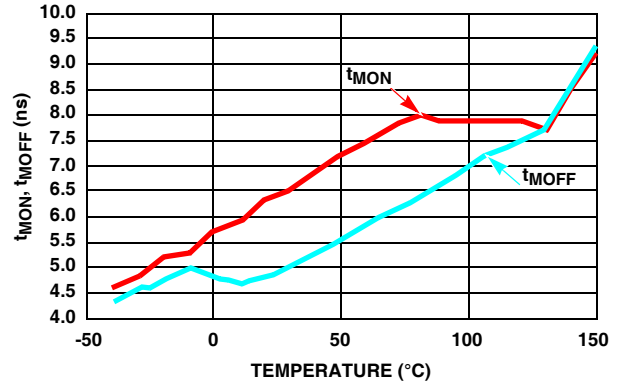

FIGURE 16. ISL2111 DELAY MATCHING vs TEMPERATURE

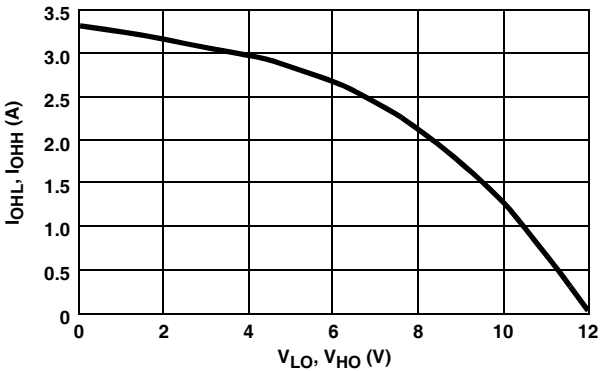

FIGURE 17. PEAK PULL-UP CURRENT vs OUTPUT VOLTAGE

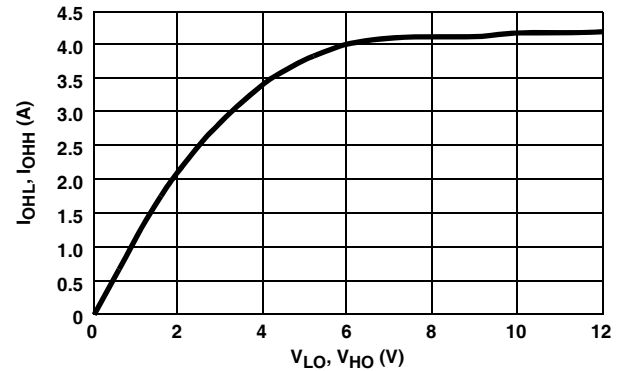

FIGURE 18. PEAK PULL-DOWN CURRENT vs OUTPUT VOLTAGE



Typical Performance Curves (Continued)

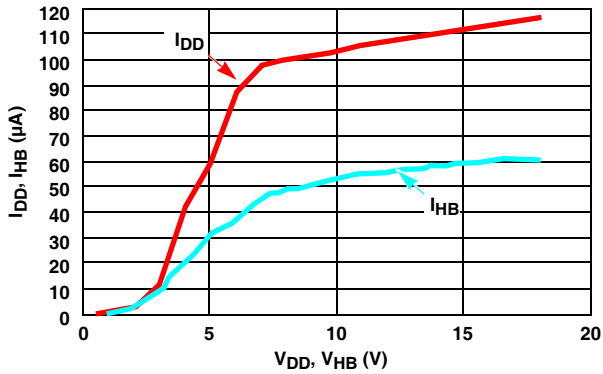

FIGURE 19. ISL2110 QUIESCENT CURRENT vs VOLTAGE

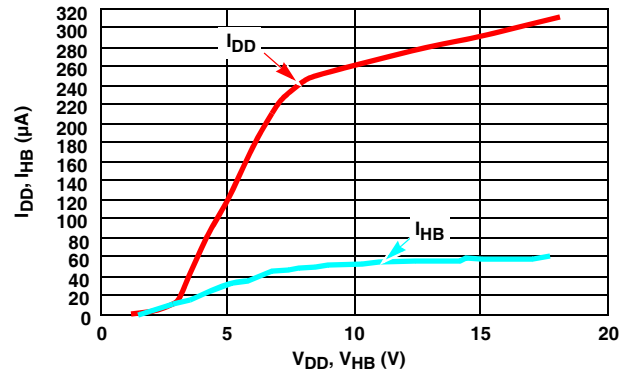

FIGURE 20. ISL2111 QUIESCENT CURRENT vs VOLTAGE

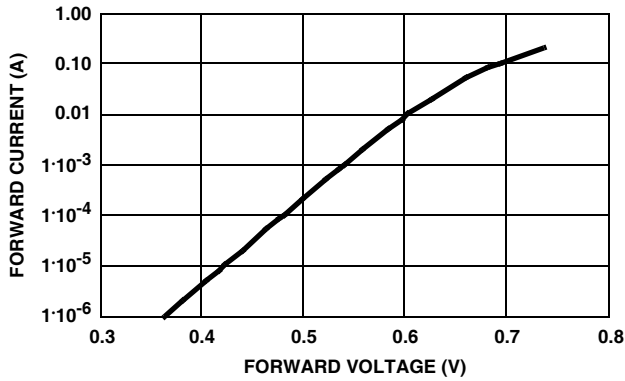

FIGURE 21. BOOTSTRAP DIODE I-V CHARACTERISTICS

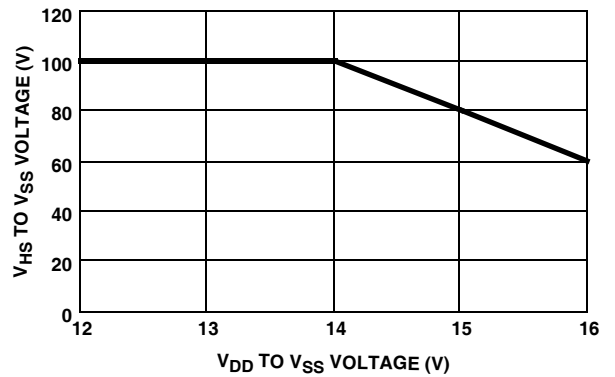

FIGURE 22. V<sub>HS</sub> VOLTAGE vs V<sub>DD</sub> VOLTAGE

All Intersil U.S. products are manufactured, assembled and tested utilizing ISO9000 quality systems. Intersil Corporation's quality certifications can be viewed at [www.intersil.com/design/quality](http://www.intersil.com/design/quality)

*Intersil products are sold by description only. Intersil Corporation reserves the right to make changes in circuit design, software and/or specifications at any time without notice. Accordingly, the reader is cautioned to verify that data sheets are current before placing orders. Information furnished by Intersil is believed to be accurate and reliable. However, no responsibility is assumed by Intersil or its subsidiaries for its use; nor for any infringements of patents or other rights of third parties which may result from its use. No license is granted by implication or otherwise under any patent or patent rights of Intersil or its subsidiaries.*

For information regarding Intersil Corporation and its products, see [www.intersil.com](http://www.intersil.com)

# Package Outline Drawing

## L10.4x4

### 10 LEAD THIN DUAL FLAT NO-LEAD PLASTIC PACKAGE

Rev 1, 1/08

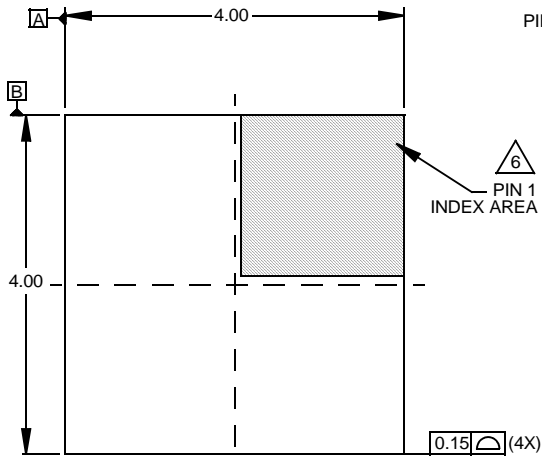

TOP VIEW

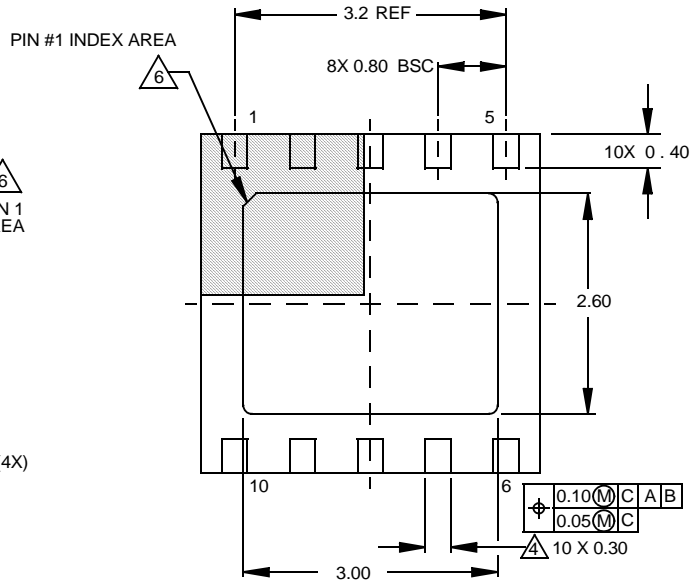

BOTTOM VIEW

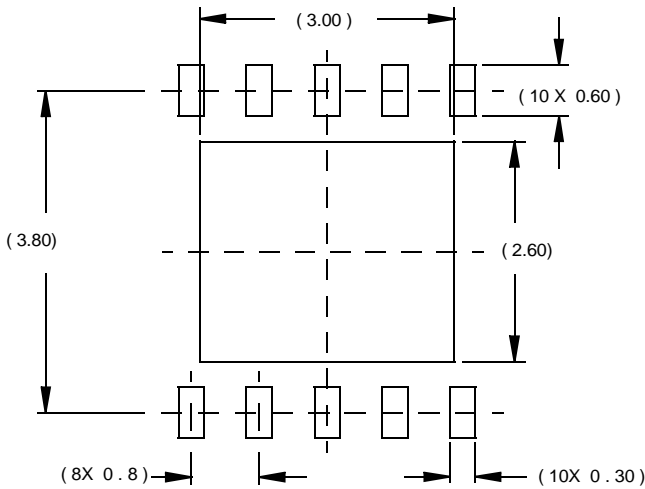

TYPICAL RECOMMENDED LAND PATTERN

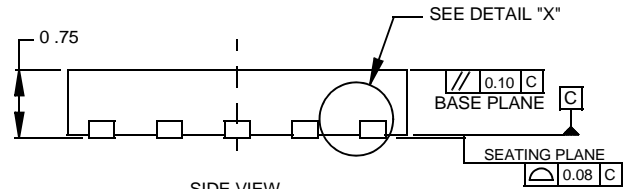

SIDE VIEW

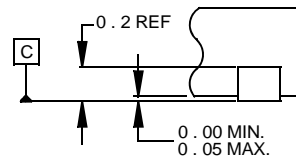

DETAIL "X"

#### NOTES:

1. Dimensions are in millimeters.  
Dimensions in ( ) for Reference Only.
2. Dimensioning and tolerancing conform to AMSE Y14.5m-1994.
3. Unless otherwise specified, tolerance : Decimal  $\pm 0.05$
4. Dimension b applies to the metallized terminal and is measured between 0.15mm and 0.30mm from the terminal tip.
5. Tiebar shown (if present) is a non-functional feature.
6. The configuration of the pin #1 identifier is optional, but must be located within the zone indicated. The pin #1 identifier may be either a mold or mark feature.

# Package Outline Drawing

## L12.4x4A

12 LEAD DUAL FLAT NO-LEAD PLASTIC PACKAGE

Rev 1, 3/11

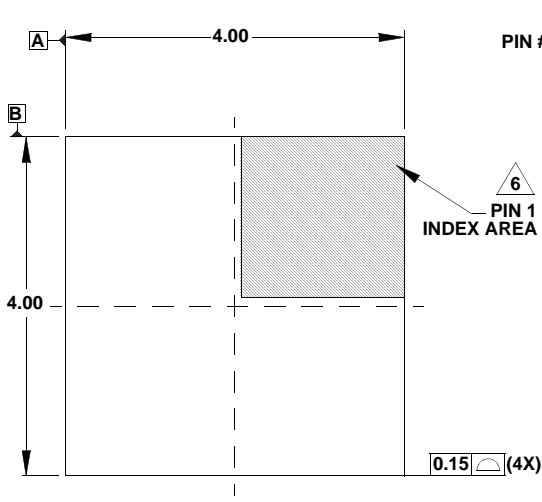

TOP VIEW

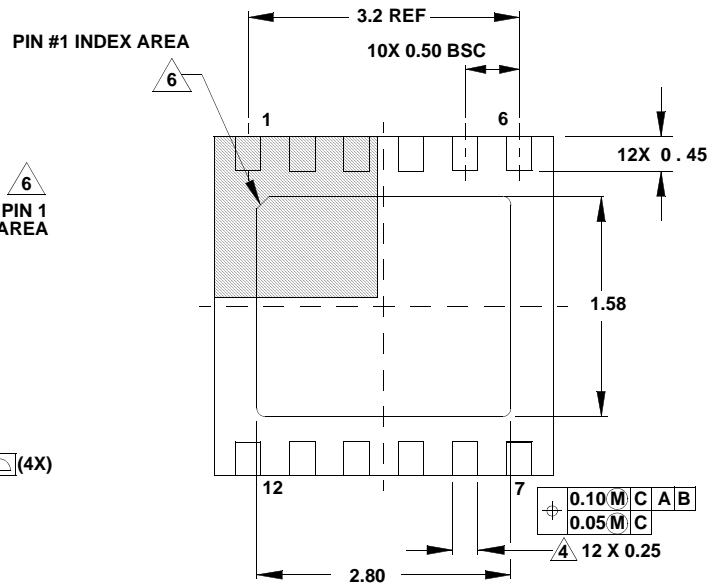

BOTTOM VIEW

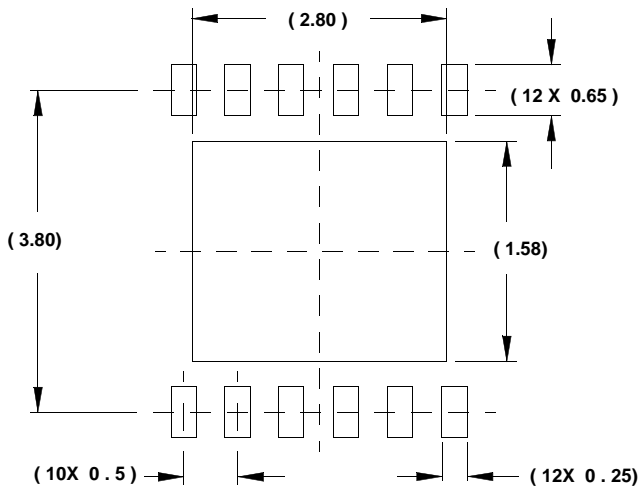

TYPICAL RECOMMENDED LAND PATTERN

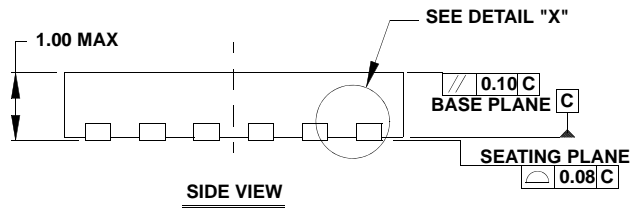

SIDE VIEW

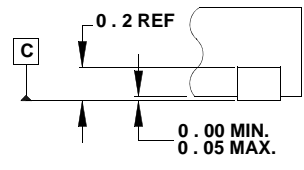

DETAIL "X"

NOTES:

1. Dimensions are in millimeters.  
Dimensions in ( ) for Reference Only.
2. Dimensioning and tolerancing conform to AMSE Y14.5m-1994.
3. Unless otherwise specified, tolerance : Decimal  $\pm 0.05$
4. Lead width applies to the metallized terminal and is measured between 0.15mm and 0.30mm from the terminal tip.
5. Tiebar shown (if present) is a non-functional feature.
6. The configuration of the pin #1 identifier is optional, but must be located within the zone indicated. The pin #1 identifier may be either a mold or mark feature.

# Package Outline Drawing

## M8.15

8 LEAD NARROW BODY SMALL OUTLINE PLASTIC PACKAGE

Rev 3, 3/11

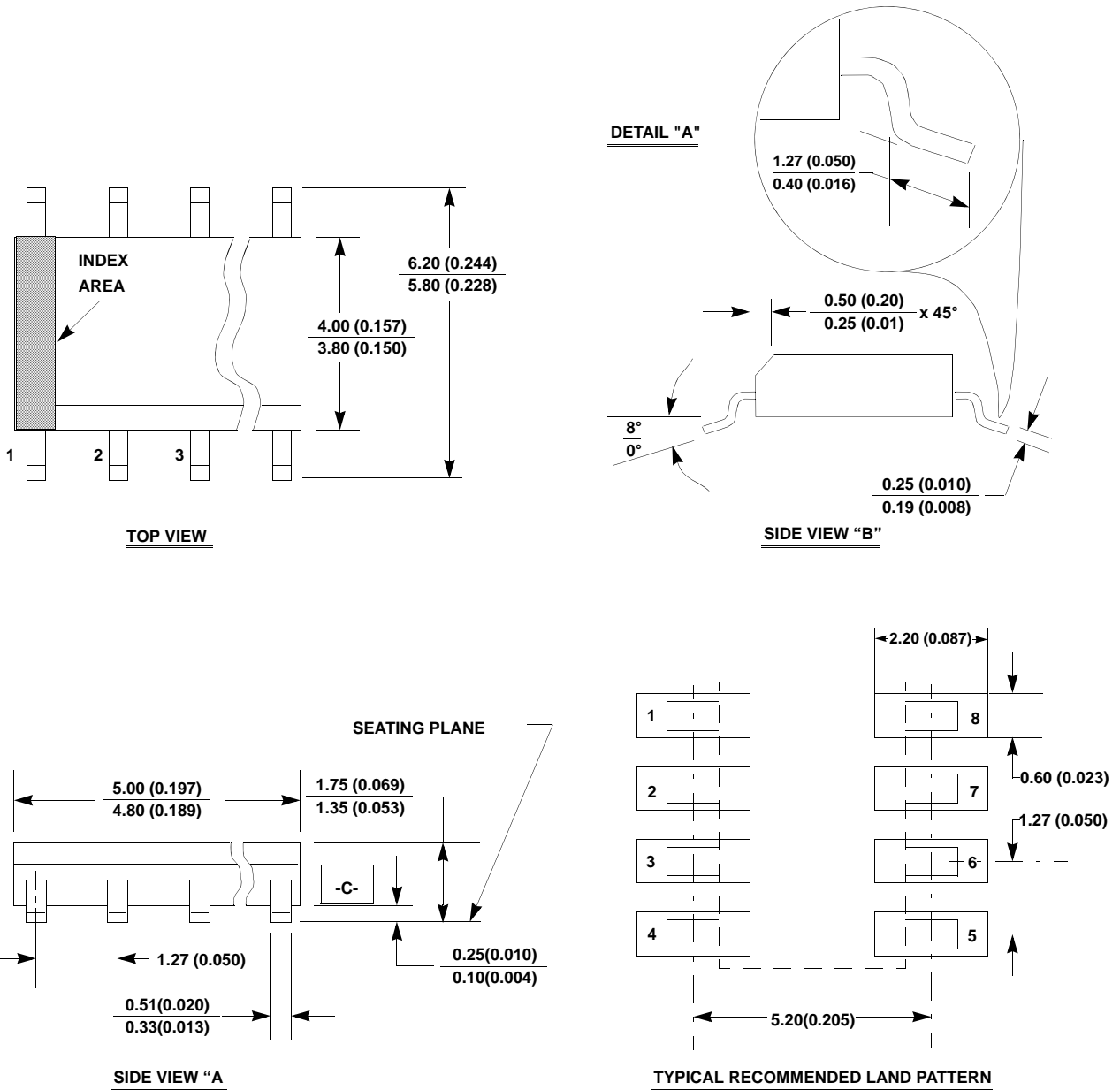

**NOTES:**

1. Dimensioning and tolerancing per ANSI Y14.5M-1982.
2. Package length does not include mold flash, protrusions or gate burrs. Mold flash, protrusion and gate burrs shall not exceed 0.15mm (0.006 inch) per side.
3. Package width does not include interlead flash or protrusions. Interlead flash and protrusions shall not exceed 0.25mm (0.010 inch) per side.
4. The chamfer on the body is optional. If it is not present, a visual index feature must be located within the crosshatched area.
5. Terminal numbers are shown for reference only.
6. The lead width as measured 0.36mm (0.014 inch) or greater above the seating plane, shall not exceed a maximum value of 0.61mm (0.024 inch).
7. Controlling dimension: MILLIMETER. Converted inch dimensions are not necessarily exact.
8. This outline conforms to JEDEC publication MS-012-AA ISSUE C.

# Package Outline Drawing

## L8.4x4

8 LEAD DUAL FLAT NO-LEAD PLASTIC PACKAGE

Rev 0, 11/09

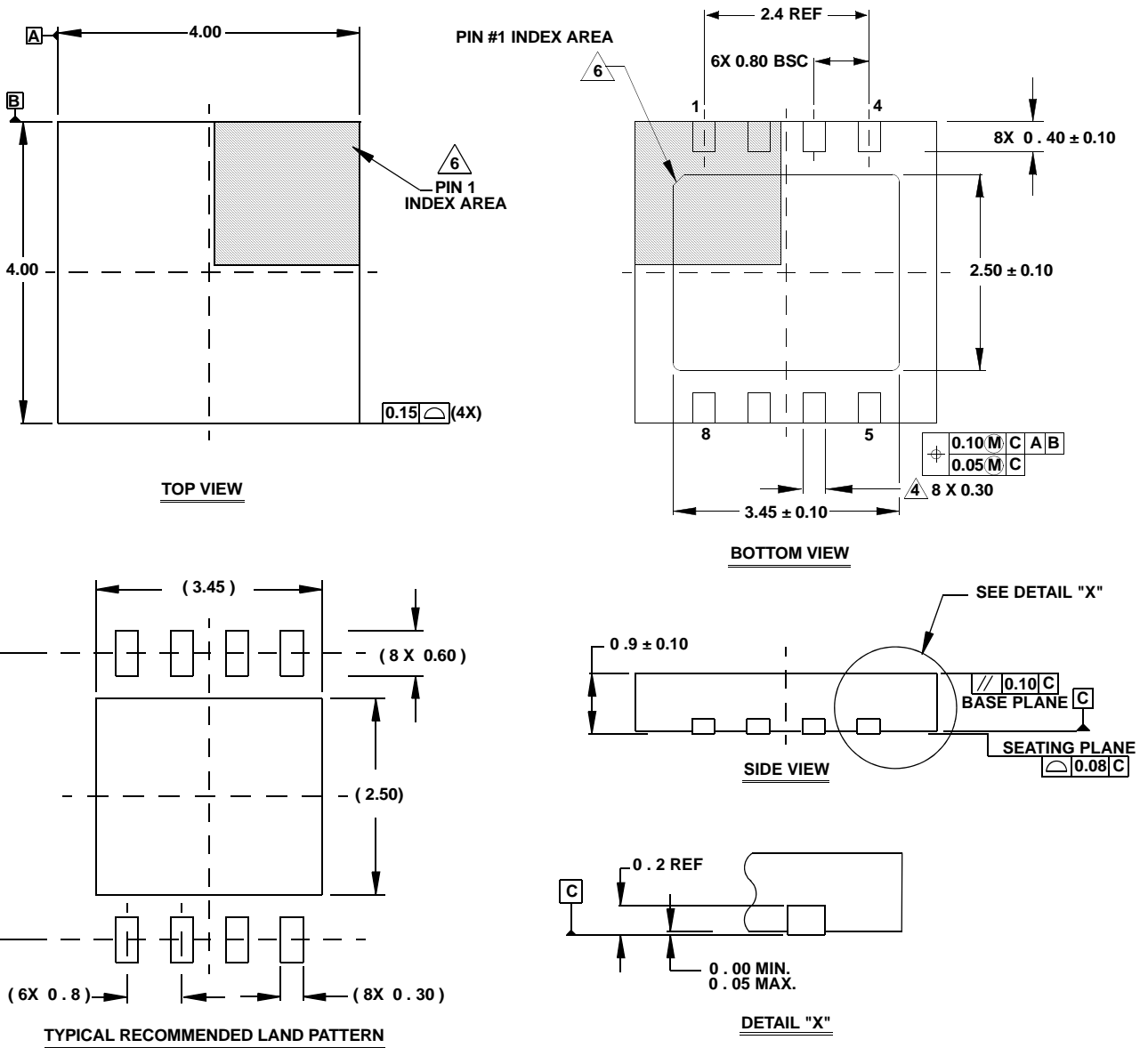

**NOTES:**

1. Dimensions are in millimeters.  
Dimensions in ( ) for Reference Only.
2. Dimensioning and tolerancing conform to ASME Y14.5m-1994.
3. Unless otherwise specified, tolerance : Decimal  $\pm 0.05$
4. Dimension applies to the metallized terminal and is measured between 0.15mm and 0.30mm from the terminal tip.
5. Tiebar shown (if present) is a non-functional feature.
6. The configuration of the pin #1 identifier is optional, but must be located within the zone indicated. The pin #1 identifier may be either a mold or mark feature.