

SINGLE-SUPPLY QUAD COMPARATOR

■ GENERAL DESCRIPTION

These devices offer higher frequency operation and faster switching than can be had from internally compensated quad op amps. Indeed for single-supply applications, the Darlington PNP input stage allows them to compare voltages that include ground. The two-stage common-emitter output circuit provides gain and output sink capacity of 6mA at an output level of 400mV. The output collector is left open, permitting the designer to drive devices in the range of 2V to 36V.

■ FEATURES

- Operating Voltage (+2V~+36V)
- Single Supply Operation
- Open Collector Output
- Package Outline DIP14,DMP14,SSOP14
- Bipolar Technology

■ PIN CONFIGURATION

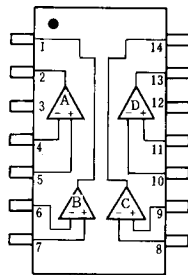

NJM2901N
NJM2901M
NJM2901V

■ PACKAGE OUTLINE

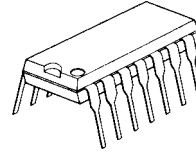

NJM2901N

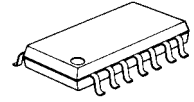

NJM2901M



NJM2901V

PIN FUNCTION

1. B OUTPUT
2. A OUTPUT
3. V⁺
4. A -INPUT
5. A +INPUT
6. B -INPUT
7. B +INPUT
8. C -INPUT
9. C +INPUT
10. D -INPUT
11. D +INPUT
12. GND
13. D OUTPUT
14. C OUTPUT

■ EQUIVALENT CIRCUIT (1/4 Shown)

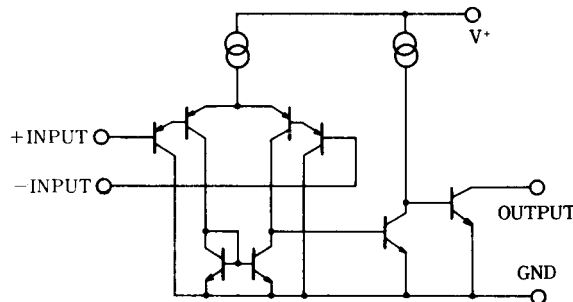

NJM2901

■ ABSOLUTE MAXIMUM RATINGS

(Ta=25°C)

PARAMETER	SYMBOL	RATINGS	UNIT
Supply Voltage	V^+	36 (± 18)	V
Differential Input Voltage	V_{ID}	36	V
Input Voltage	V_{IN}	-0.3~+36	V
Power Dissipation	P_D	(DIP14) 570 (DMP14) 300 (SSOP14) 300	mW
Operating Temperature Range	T_{opr}	-40~+85	°C
Storage Temperature Range	T_{stg}	-50~+125	°C

■ ELECTRICAL CHARACTERISTICS

(Ta=25°C, $V^+=5V$)

PARAMETER	SYMBOL	TEST CONDITION	MIN.	TYP.	MAX.	UNIT
Input Offset Voltage	V_{IO}	$R_S=0\Omega, V_O=1.4V$	-	2	7	mV
Input Offset Current	I_{IO}	$I_{IN}=I_{IN^+}-I_{IN^-}$	-	5	50	nA
Input Bias Current	I_B		-	25	250	nA
Input Common Mode Voltage Range	V_{ICM}		0~3.5	-	-	V
Large Signal Voltage Gain	A_V	$R_L=15k\Omega$	-	106	-	dB
Response Time	t_R	$R_L=5.1k\Omega$	-	1.3	-	μs
Output Sink Current	I_{SINK}	$V_{IN^-}=1V, V_{IN^+}=0V, V_O=1.5V$	6	16	-	mA
Output Saturation Voltage	V_{SAT}	$V_{IN^-}=1V, V_{IN^+}=0V, I_{SINK}=3mA$	-	200	400	mV
Output Leakage Current	I_{LEAK}	$V_{IN^-}=0V, V_{IN^+}=1V, V_O=5V$	-	0.1	1.0	μA
Operating Current	I_{CC}	$R_L=\infty$	-	0.8	2	mA

■ TYPICAL CHARACTERISTICS

Input Offset Voltage vs. Temperature
($V^+ = 5\text{ V}$)

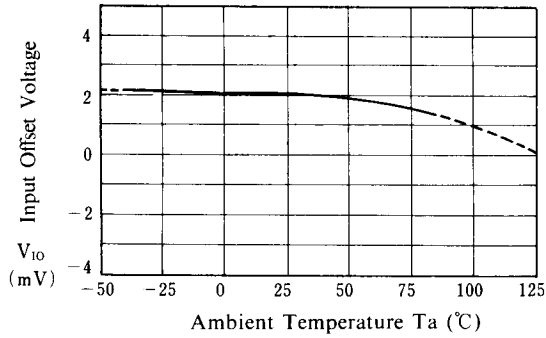

Operating Current
($R_L = \infty$)

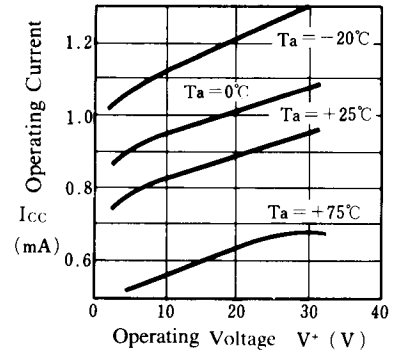

Input Bias Current

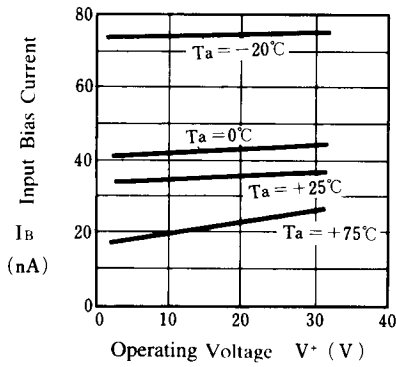

Output Saturation Voltage
($V^+ = 5\text{ V}$)

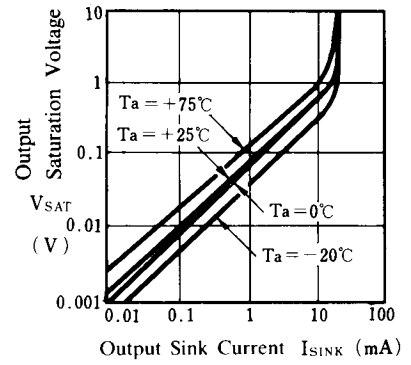

Response Time for Various Input Over Drives
($V^+ = 5\text{ V}$, $R_L = 5.1\text{ k}\Omega$, $T_a = 25^\circ\text{ C}$)

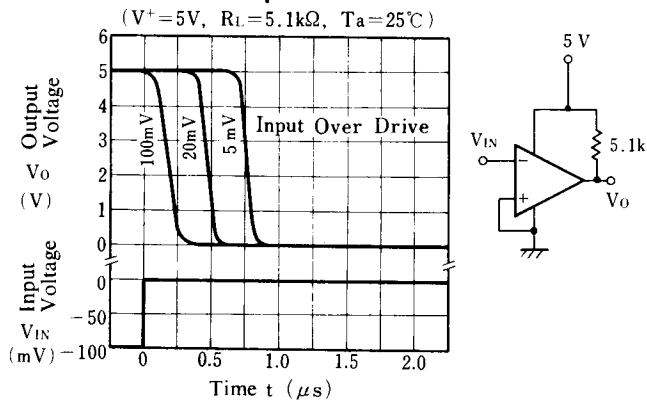

Response Time for Various Input Over Drives
($V^+ = 5\text{ V}$, $R_L = 5.1\text{ k}\Omega$, $T_a = 25^\circ\text{ C}$)

