

Contents

1	KCLP1856CR	12° FWHM - DIA 50mm	Pag. 2
2	KCLP1856ME	30° FWHM - DIA 50mm	Pag. 3
3	KCLP1856WI	50° FWHM - DIA 50mm	Pag. 4
4	KCLP1856CR Drawing		Pag. 5
5	KCLP1856ME Drawing		Pag. 6
6	KCLP1856WI Drawing		Pag. 7
7	How to Order		Pag. 8
8	Accessories	For Bridgelux Vero	Pag. 8
9	How to Order: Examples		Pag. 8
10	Materials / Use and Maintenance / Disclaimer		Pag. 9

1. KCLP1856CR - 50mm Narrow Beam Angle

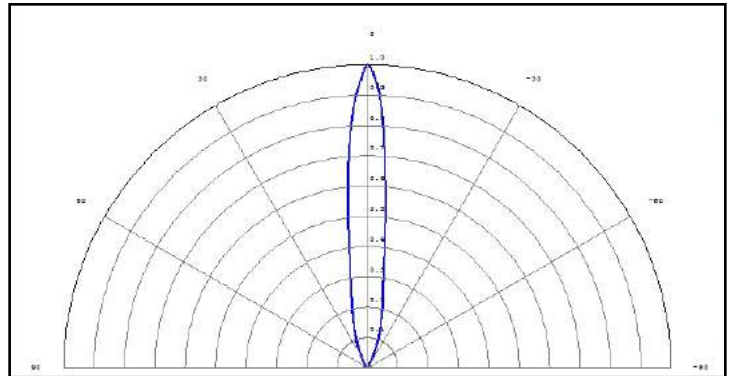

- Material = APEC + Reflector Coating
- Full angle at 50% : ~ 12°
- Full angle at 10% : ~ 32°-37°
- The light spots here represented refer to tests carried out with CoB LEDs @ 1000lm

50mm
12° FWHM



Secondary Reflector

Twist and Lock



25.00

M3 Screws (Not Provided)

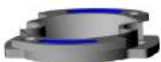

Primary Reflector (see pag. 8 for different Manufacturers of CoBs)



LED Connector (Not provided.
Available from BJB, Molex, Ideal, Tyco, Arditi, Bender+Wirth, Stucchi...)



CoB LES Ø 9-11mm

[How to Assemble](#)

2. KCLP1856ME - 50mm Medium Beam Angle

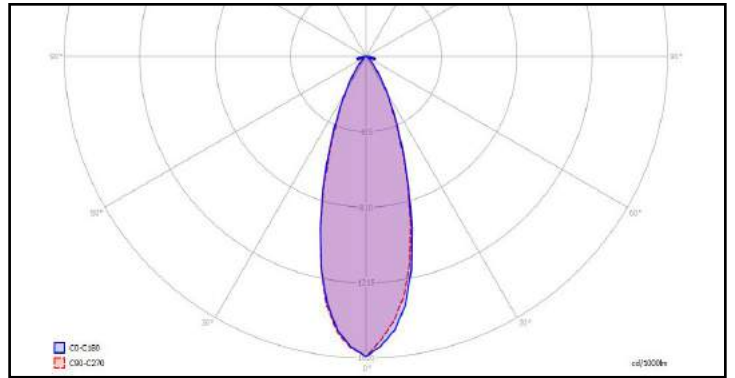

- Material = APEC + Reflector Coating
- Full angle at 50% : ~ 34°
- Full angle at 10% : ~ 63°
- The light spots here represented refer to tests carried out with CoB LEDs @ 1000lm

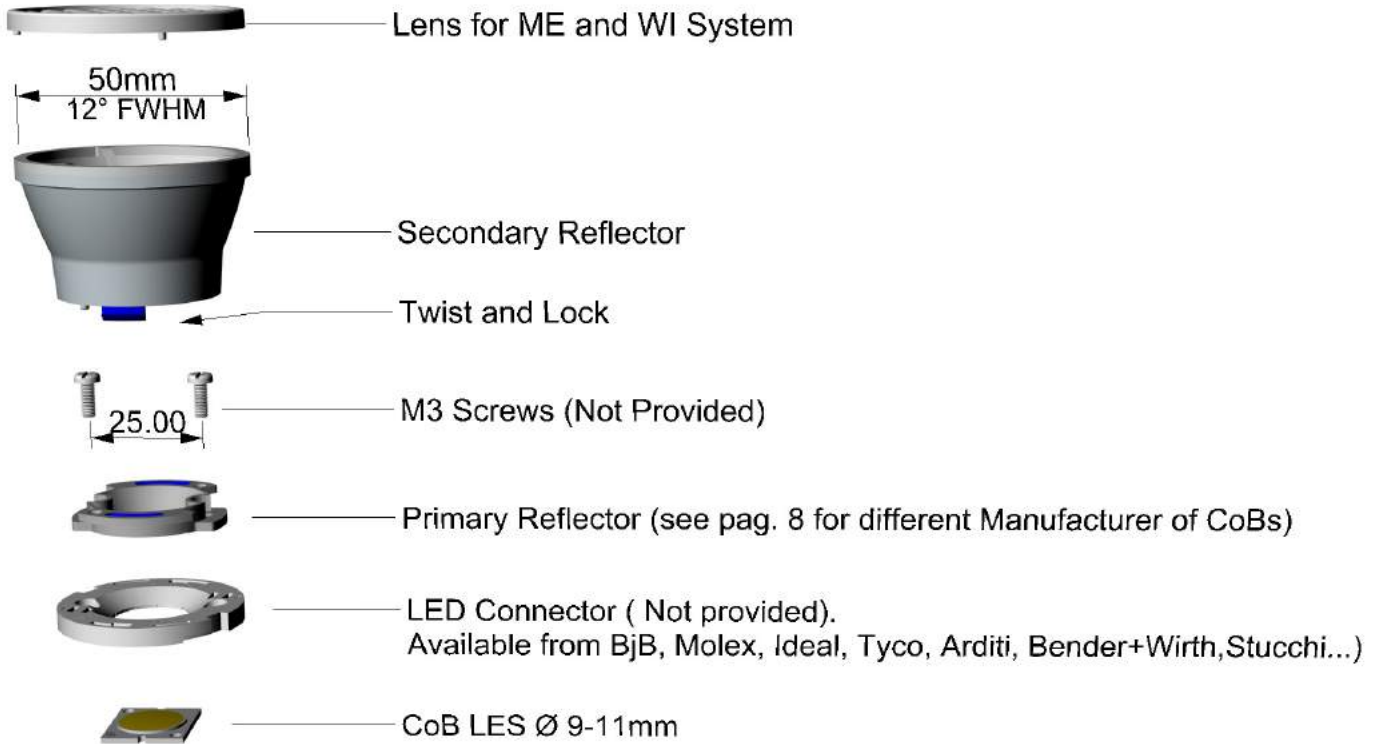

How to Assemble

3. KCLP1856WI - 50mm Wide Beam Angle

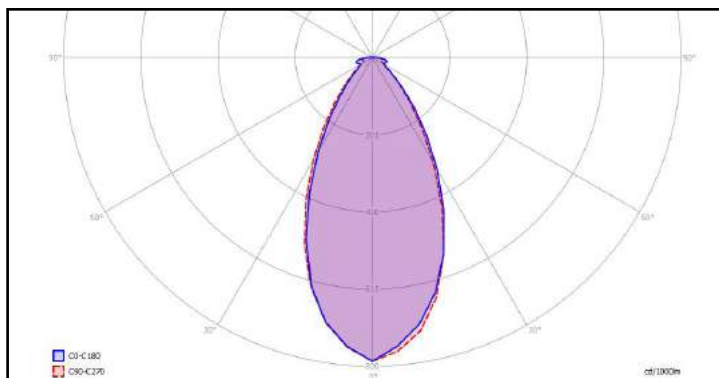

- Material = APEC + Reflector Coating
- Full angle at 50% : ~ 51°
- Full angle at 10% : ~ 97°
- The light spots here represented refer to tests carried out with CoB LEDs @ 1000lm

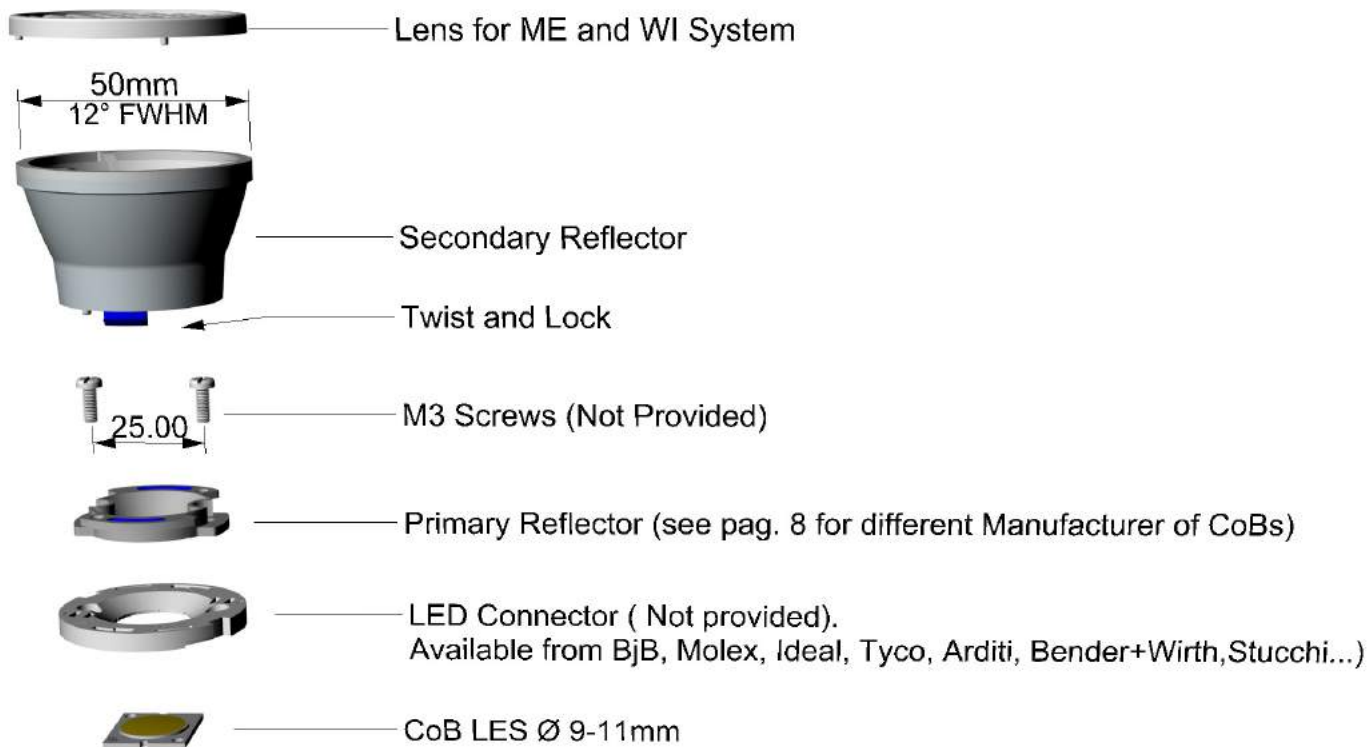

[How to Assemble](#)

4. KCLP1856CR Drawing

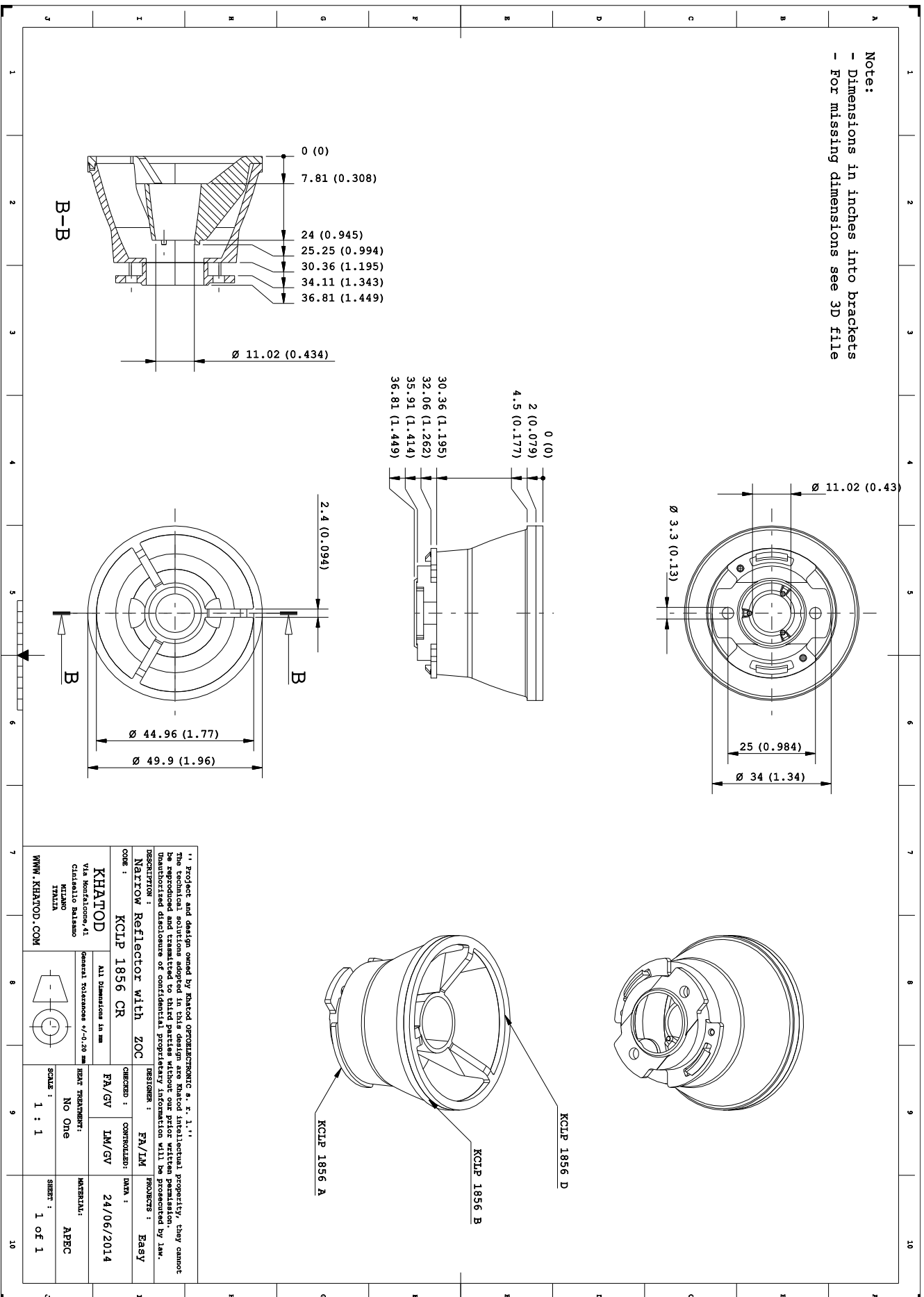

5. KCLP1856ME Drawing

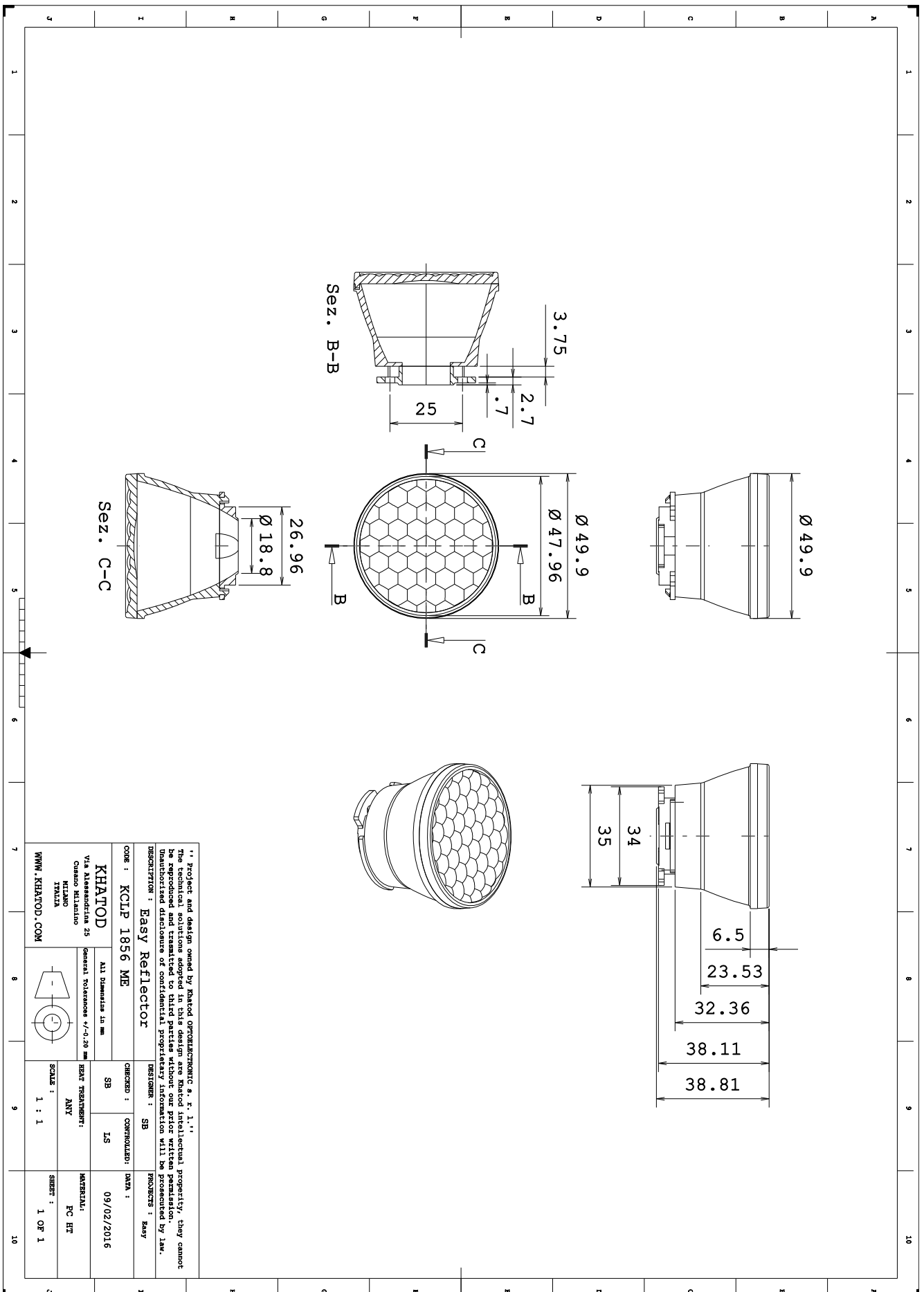

Project and design owned by Khatod OPTOELECTRONIC S. r. l. The technical solutions adopted in this design are Khatod intellectual property, they cannot be reproduced and transmitted to third parties without our prior written permission. Unauthorized disclosure of confidential proprietary information will be prosecuted by law.

DESIGNER : Easy Reflector
PRODUCTS : Easy

CODE : KCLP 1856 ME
CHECKED : SB
CONTROLLED : LS
DATE : 09/02/2016

KHATOD
Via Alessandro 25
Cesano Maderno
Milano
Italy
WWW.KHATOD.COM

General Tolerances +/- 0.20 mm
HEAT TREATMENT: ANY
MATERIAL: PC HT

SCALE : 1 : 1
SHEET : 1 OF 1

7. How to Order

KCLP XXXX XX XXXX

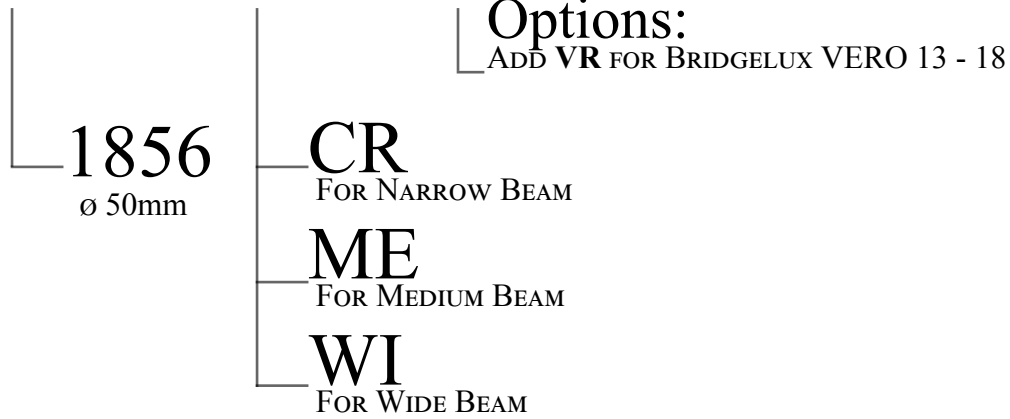

8. Options

VR - Primary Reflector for Bridgelux Vero 13 & 18 CoB Series

9. How to Order: Examples

1 - 50mm Diameter, Narrow Beam

KCLP 1856 CR

2 - 50mm Diameter Medium Beam

KCLP 1856 ME

3 - 50mm Diameter Wide Beam

KCLP 1856 WI

3 - 50mm Diameter, Wide Beam with Primary Reflector for Bridgelux Vero:

KCLP 1856 WI VR

10. Materials

Material	Top	Tstg
Reflector: PC APEC + Aluminum Coating with protective Clear Coating	-40°...150°C	-40°...150°C
Lens: Clear PMMA	-40°...90°C	-40°...90°C

Notes:

- Intensity (I) and illuminance (E) data are normalized by 1000 lm
- The optical values shown are the result of optical simulations carried out with ASAP and ZEMAX software systems. The optical simulations are carried out on the basis of the typical values provided in the LED manufacturers' official datasheets. The photometric analysis has been carried out on physical samples. On request, by supplying your PCB, we can provide the measurement photometric file.

Use and Maintenance

- DO NOT HANDLE OR INSTALL LENSES OR REFLECTORS WITHOUT WEARING GLOVES, SKIN OILS MAY DAMAGE LENS OR LIGHT TRANSMISSION;
- CLEAN LENSES WITH MILD SOAP AND WATER AND DRY WITH A CLEAN SOFT CLOTH; DO NOT CLEAN REFLECTORS
- DO NOT USE ANY COMMERCIAL CLEANING SOLVENTS ON LENSES.

Disclaimer

Please note that flow lines and weld lines on the external surfaces of the lenses are acceptable if the optical performance of the lens is within the specifications.

Should you require further information, please contact Khatod for advice. All lens testing must be subject to identical conditions as Khatod test condition. Khatod Optoelectronic, Milan, Italy, manufactures lenses for LEDs. Any other use of the lens shall void our liability and warranty. The lenses are an inert component to be used in the manufacture of various products. Our warranty and liability are limited only to the manufacture of the lens. You may not modify, copy, distribute reproduce, license or alter the lens and related materials of Khatod. Khatod does not warrant against damages or defects arising out of the use or misuse of the products; against defects or damage arising from improper installation, or against defects in the product or in its components. No warranty of any kind, expressed or implied, is made regarding the safety of the products. The entire risk as to the quality or performance of the product is with the buyer. In no event shall Khatod be liable for any direct, indirect, punitive, incidental, special, consequential damages, or any damages whatsoever arising out of or connected with the use or misuse of the product. Khatod shall not have any obligation with respect to the product or any part thereof, whether based on contract, tort, strict liability or otherwise. Buyer assumes all risks and liability from use of the product. The laws of Milan, Italy govern this product warranty and liability and you hereby consent to the exclusive jurisdiction and venue of courts in Milan, Italy in all disputes arising out of or relating to the use of this product. Production, marketing, distribution, sale of these products as well as their possible modifications and variations are only exclusive right of Khatod Optoelectronic. No company can perform any of these actions without written permission released by Khatod Optoelectronic. The information contained in this document is proprietary information of Khatod Optoelectronic and may change without notice.

REPRODUCTION PROHIBITED.