



TXM-315-LC
TXM-418-LC
TXM-433-LC



LC SERIES TRANSMITTER MODULE DATA GUIDE

DESCRIPTION:

The LC Series is ideally suited for volume use in OEM applications such as remote control, security, identification, and periodic data transfer. Packaged in a compact SMD package, the LC transmitter utilizes a highly optimized SAW architecture to achieve an unmatched blend of performance, size, efficiency and cost. When paired with a matching LC series receiver, a highly reliable wireless link is formed, capable of transferring serial data at distances in excess of 300 Feet. No external RF components, except an antenna, are required, making design integration straightforward, even for engineers lacking previous RF experience.

PHYSICAL DIMENSIONS

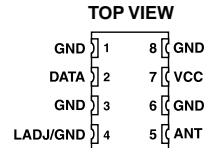
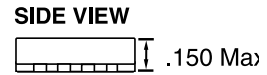
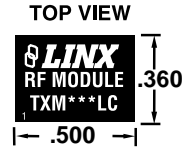

FEATURES:

- Low Cost
- No External RF Components Required
- Ultra-low Power Consumption
- Compact Surface-Mount Package
- Stable SAW-based Architecture
- Supports Data Rates to 5,000 bps
- Wide Supply Range (2.7-5.2 VDC)
- Direct Serial Interface
- Low Harmonics
- No Production Tuning

APPLICATIONS INCLUDE:

- Remote control
- Keyless entry
- Garage / Gate openers
- Lighting control
- Medical monitoring / Call systems
- Remote industrial monitoring
- Periodic data transfer
- Home / Industrial automation
- Fire / Security alarms
- Remote status / Position sensing
- Long-range RFID
- Wire Elimination

PINOUTS

ORDERING INFORMATION

PART #	DESCRIPTION
EVAL-***-LC	Basic Evaluation Kit
MDEV-***-LC	Master Development Kit
TXM-315-LC	Transmitter 315 MHz
TXM-418-LC	Transmitter 418 MHz
TXM-433-LC	Transmitter 433 MHz
RXM-315-LC	Receiver 315 MHz
RXM-418-LC	Receiver 418 MHz
RXM-433-LC	Receiver 433 MHz

*** Insert Frequency

Not covered in this manual

LC Transmitters are supplied in tube packaging - 50 pcs. per tube.

PERFORMANCE DATA- TXM-***-LC

ABOUT THESE MEASUREMENTS

The performance parameters listed below are based on module operation at 25°C from a 3.3Vdc supply unless otherwise noted. Figure 1 at the right illustrates the connections necessary for testing and operation. It is recommended that all ground pins be connected to the groundplane.

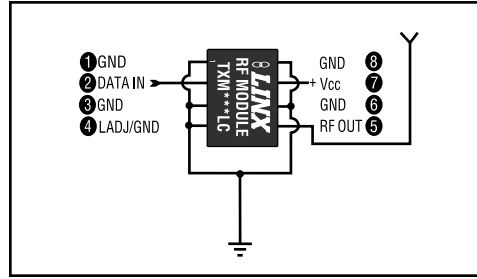

figure 1: Test/Basic application circuit

Parameters	Designation	Min.	Typical	Max.	Units	Notes
LCTX 433, 418, 315MHz						
Operating Voltage Range	V _{CC}	2.7	-	5.2	Volts	-
Current Continuous	I _{CC}	-	3.0	6.0	mA	1, 5
Current Average	I _{CA}	-	1.5	-	mA	2, 5
Current In Sleep	I _{SLP}	-	-	1.5	µA	3
Data Input Low	V _{IL}	0	-	0.4	Volts	-
Data Input High	V _{IH}	2.5	-	V _{CC}	Volts	-
Oscillator Start-up Time	T _{OSU}	-	-	80	µS	4
Oscillator Ring-down Time	T _{ORD}	-	-	100	nSec	4
Output Power	P _O	-4	0	+4	dBm	4

Parameter	Designation	Min.	Typical	Max.	Units	Notes
LCTX 315MHz						
Frequency of Carrier	F _C	314.925	315.0	315.075	MHz	-
Harmonic Emissions	P _H	-	-	-40	dBc	4

Parameter	Designation	Min.	Typical	Max.	Units	Notes
LCTX 418MHz						
Frequency of Carrier	F _C	417.925	418	418.075	MHz	-
Harmonic Emissions	P _H	-	-	-40	dBc	4

Parameter	Designation	Min.	Typical	Max.	Units	Notes
LCTX 433MHz						
Frequency of Carrier	F _C	433.845	433.92	433.995	MHz	-
Harmonic Emissions	P _H	-	-	-45	dBc	4

Notes:

1. Current draw with data pin held continuously high.
2. Current draw with 50% mark/space ratio.
3. Current draw with data pin low.
4. RF out connected to 50Ω load.
5. Ladj (pin 4) through 430Ω resistor.

Absolute Maximum Ratings:

Supply voltage V _{CC} , using pin 7	-0.3	to	+6	VDC
Operating temperature	-30°C	to	+70°C	
Storage temperature	-45°C	to	+85°C	
Soldering temperature	+225°C for 10 sec.			
Any input or output pin	-0.3	to	V _{CC}	

NOTE Exceeding any of the limits of this section may lead to permanent damage of the device. Furthermore, extended operation at these maximum ratings may reduce the life of this device.

TYPICAL PERFORMANCE GRAPHS

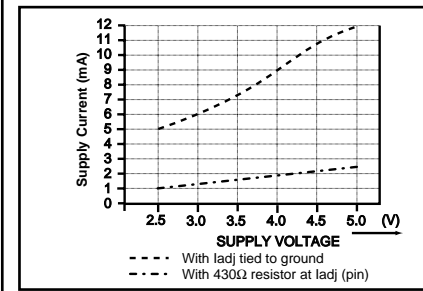

figure 2: Consumption vs. Supply Voltage

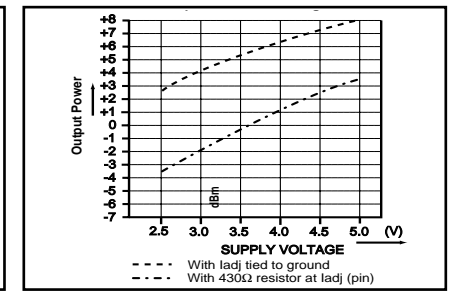

figure 3: Typical RF power into 50Ω

figure 4: Typical Oscillator Turn-On Time

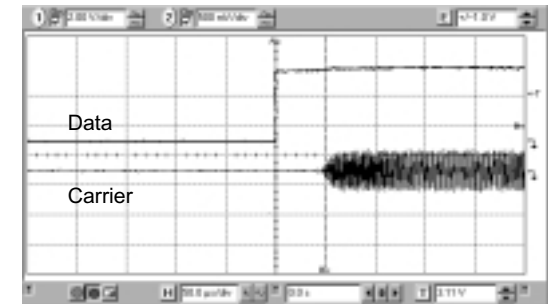
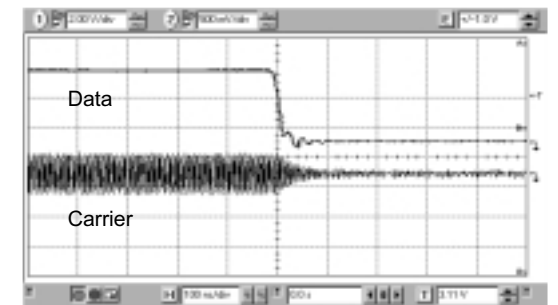

figure 5: Typical Oscillator Turn-Off Time



TRANSMITTER AUTOMATED ASSEMBLY

For high-volume assembly most users will want to auto-place the modules. The modules have been designed to maintain compatibility with most pick-and-place equipment; however, due to the module's hybrid nature certain aspects of the automated assembly process are far more critical than for other component types.

Following are brief discussions of the three primary areas where caution must be observed.

Reflow Temperature Profile

The single most critical stage in the automated assembly process is the reflow process. The reflow profile below should be closely followed since excessive temperatures or transport times during reflow will irreparably damage the modules. Assembly personnel will need to pay careful attention to the oven's profile to insure that it meets the requirements necessary to successfully reflow all components while still meeting the limits mandated by the modules themselves.

Shock During Reflow Transport

Since some internal module components may reflow along with the components placed on the board being assembled, it is imperative that the module not be subjected to shock or vibration during the time solder is liquidus.

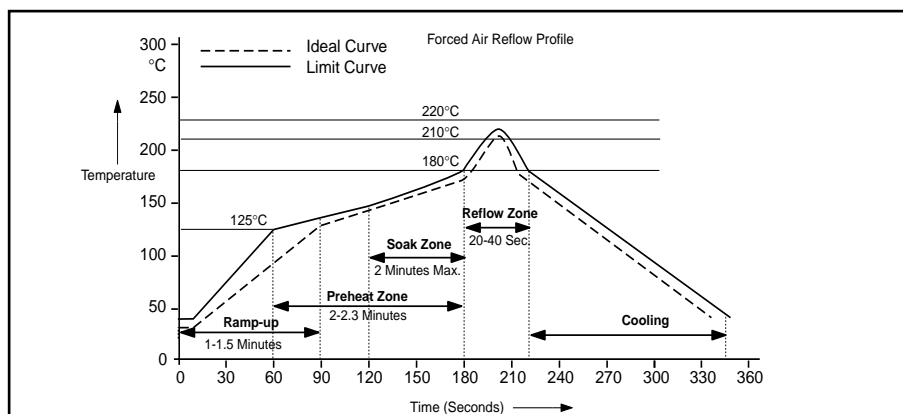

figure 6: Required reflow profile

Washability

The modules are wash resistant, but are not hermetically sealed. They may be subject to a standard wash cycle; however, a twenty-four-hour drying time should be allowed before applying electrical power to the modules. This will allow any moisture that has migrated into the module to evaporate, thus eliminating the potential for shorting during power-up or testing.

PRODUCTION GUIDELINES

The LC modules are packaged in a hybrid SMD package which has been designed to support hand- or automated-assembly techniques. Since LC devices contain discrete components internally, the assembly procedures are critical to insuring the reliable function of the LC product. The following procedures should be reviewed with and practiced by all assembly personnel.

PAD LAYOUT

The following pad layout diagrams are designed to facilitate both hand and automated assembly.

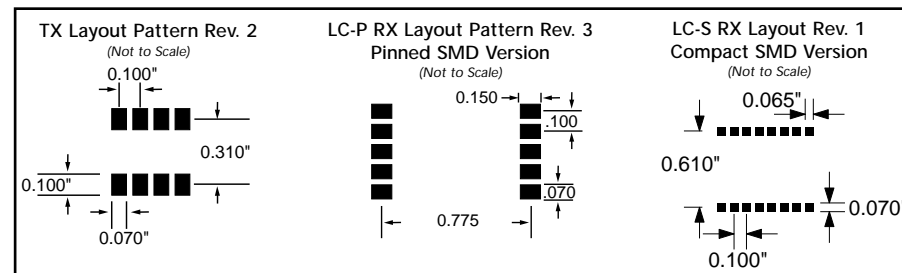

figure 7: Suggested Pad Layout

TRANSMITTER HAND ASSEMBLY

The LC transmitter's primary mounting surface is eight pads located on the bottom of the module. Since these pads are inaccessible during mounting, castellations that run up the side of the module have been provided to facilitate solder wicking to the module's underside. If the recommended pad placement (Rev.2) has been followed, the pad on the board will extend slightly past the edge of the module. Touch both the PCB pad and the module castellation with a fine soldering tip. Tack one module corner first, then work around the remaining attachment points using care not to exceed the solder times listed below.

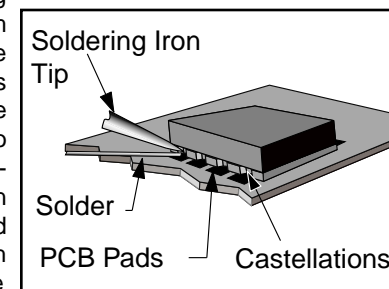

Figure 8: LC-TX Soldering Technique

Absolute Maximum Solder Times

Hand-Solder Temp. TX +225°C for 10 Sec.
 Hand-Solder Temp. RX +225°C for 10 Sec.
 Recommended Solder Melting Point +180°C
 Reflow Oven: +220° Max. (See adjoining diagram)

PHYSICAL PACKAGING

The transmitter is packaged as a hybrid SMD module with eight pads spaced 0.100" apart on center. The SMD package is equipped with castellations which allow for side introduction of solder. This simplifies prototyping or hand assembly while maintaining compatibility with automated pick-and-place equipment. Modules are available in tube or tape-and-reel packaging (see page 1 for ordering information).

PIN DESCRIPTIONS:

Pin 1 GROUND

Connect to quiet ground or groundplane.

Pin 2 DATA IN

Serial data input pin. TTL and CMOS compatible.

Pin 3 GROUND

Connect to quiet ground or groundplane.

Pin 4 LADJ/GND

Output power level adjustment. Connect to ground for 3V operation. Connect to ground through 430 Ohm resistor for 5V operation. (see graph on page 3 and page 10)

Pin 5 RF OUT

Connect to 50Ω matched antenna.

Pin 6 GROUND

Connect to quiet ground or groundplane.

Pin 7 POSITIVE SUPPLY (V_{CC} 2.7-6 VDC)

The supply must be clean (<20 mV pp), stable and free of high-frequency noise. A supply filter is recommended unless the module is operated from its own regulated supply or battery.

Pin 8 GROUND

Connect to quiet ground or groundplane.

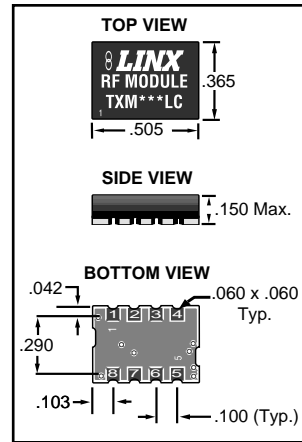

figure 9: LC-TXM Physical Package

POWER SUPPLY REQUIREMENTS

The transmitter module requires a clean, well-regulated power source. While it is preferable to power the unit from a battery, the unit can also be operated from a power supply as long as noise and 'hash' are kept to less than 20 mV. A 10Ω resistor in series with the supply followed by a 10μF tantalum capacitor from V_{CC} to ground as shown at the right will help in cases where the quality of supply power is poor.

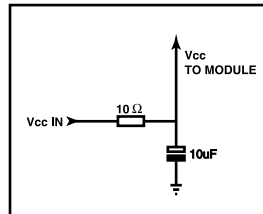

figure 10: Supply Filter

MODULE DESCRIPTION

The LC-TXM is a low-cost, high-performance SAW (Surface Acoustic Wave) based CPCA (Carrier-Present Carrier-Absent) transmitter capable of sending serial data at up to 5,000 bits/second. The LC's compact surface-mount package integrates easily into existing designs and is equally friendly to prototype and volume production. The LC's ultralow power consumption makes it ideally suited for battery powered products. When combined with a Linx LC series receiver a reliable RF link capable of transferring data over line-of-sight distances in excess of 300 feet (90M) is formed.

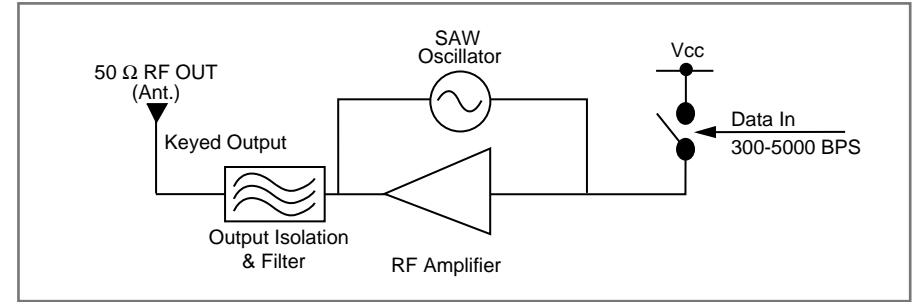

figure 11: LC Series Transmitter Block Diagram

THEORY OF OPERATION

The LC-TXM transmits data using CPCA (Carrier-Present Carrier-Absent) modulation. This type of AM modulation is often referred to by other designations including CW and OOK. This type of modulation represents a logic low '0' by the absence of a carrier and a logic high '1' by the presence of a carrier. This modulation method affords numerous benefits. Three of the most important are: 1) Cost-effectiveness due to design simplicity. 2) No minimum data rate or mark/space ratio requirement. 3) Higher output power and thus greater range in countries (such as the US) where output power measurements are averaged over time. (Please refer to Linx application note #00130).

The LC-TXM is based on a simple but highly optimized architecture which achieves a high fundamental output power with low harmonic content. This insures that most approval standards can be met without external filter components. The LC transmitter is exceptionally stable over time, temperature, and physical shock as a result of the precision SAW (Surface Acoustic Wave) frequency reference. Due to the of the SAW device most of the output power is concentrated in a narrow bandwidth. This allows the receiver's pass opening can be quite narrow, thus increasing sensitivity and reducing susceptibility to near-band interference. The quality of components and overall architecture utilized in the LC series is unusual in a low-cost RF device and is one reason the LC transmitter is able to outperform far more expensive products.

THE DATA INPUT

A CMOS/TTL level data input is provided on pin 2. This pin is normally supplied with a serial bitstream input directly from a microprocessor, encoder, or UART. During standby or the input of a logic low, the carrier is fully suppressed and the transmitter consumes less than 2μA of current. During a logic high the transmitter generates a carrier to indicate to the receiver the presence of a logic 1. The applied data should not exceed a rate of 5,000 bits/sec. The data input pin should always be driven with a voltage common to the supply voltage present at pin 7 (V_{CC}). The data pin should never be allowed to exceed the supply voltage (V_{CC}).

TRANSMITTING DATA

Once a reliable RF link has been established, the challenge becomes how to effectively transfer data across it. While a properly designed RF link provides reliable data transfer under most conditions, there are still distinct differences from a wired link that must be addressed. Since the LC modules do not incorporate internal coding/decoding, a user has tremendous flexibility in how data is formatted and sent.

It is always important to separate what type of transmissions are technically possible from those that are legally allowable in the country of intended operation. You may wish to review application notes #00125 and #00140 along with Part 15 Sec. 231 for further details on acceptable transmission content.

Another consideration is that of data structure or protocol. If you are not familiar with the sending serial data in a wireless environment read Linx application note #00232 (Considerations for sending data with the LC series). This application note details important issues such as the effect of start-up times, pulse stretching and shortening and the relationship between data and output power in a CPCA-based transmitter. These issues should be understood prior to commencing a design effort.

If you want to send simple control or status signals such as button presses or switch closures, consider using an encoder and decoder IC set available from a wide range of manufacturers including: Microchip (Keeloq), Holtek, and Motorola. These IC's take care of all encoding, error checking, and decoding functions and generally provide a number of data pins to which switches can be directly connected. Address bits are usually provided for security and to allow the addressing of multiple receivers independently. Additionally, it is a simple task to interface with inexpensive microprocessors such as the Microchip PIC or one of many IR, remote control, DTMF, and modem IC's.

Shown below is an example of a basic remote control transmitter utilizing a encoder chip from Holtek. When a key is pressed at the transmitter, a corresponding pin at the receiver goes high. A schematic for the receiver/decoder circuit may be found in the LC receiver guide.

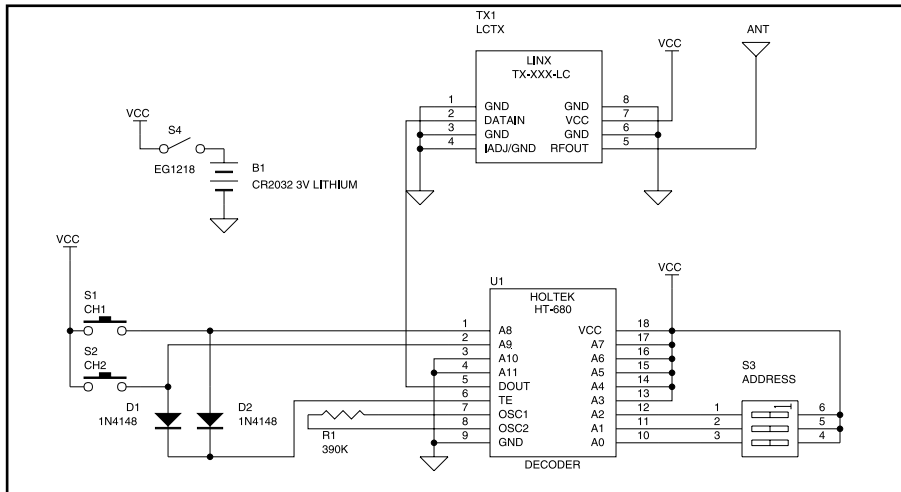

figure 12: Basic Remote Control Transmitter Circuit

Notes:

1) DIP Switch used to set ID code. A 3-position switch was chosen for this example but all or none of the address bits may be used. Settings of the Receiver and Transmitter must match for signal to be recognized.

Page 8

BOARD LAYOUT CONSIDERATIONS

If you are at all familiar with RF devices you may be concerned about specialized board layout requirements. Fortunately, because of the care taken by Linx in designing the LC series, integration is very straightforward. This ease of application results from the advanced multi-layer construction of the module. By adhering to the following layout principles and observing a few basic design rules, you can enjoy a straightforward path to RF success.

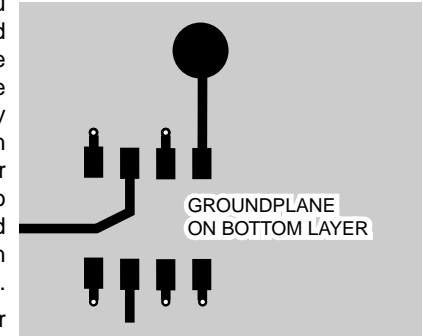

figure 13: Example of proper groundplane

1. A groundplane should be placed under the module as shown. It will generally be placed on the bottom layer. The amount of overall plane is also critical for the correct function of many antenna styles and is covered in the next section.
2. Observe appropriate layout practice between the module and its antenna. A simple trace may suffice for runs of less than .25" but longer distances should be covered using 50Ω coax or a 50Ω microstrip transmission line. In order to minimize loss and detuning, a microstrip transmission line is commonly utilized. The term microstrip refers to a PCB trace running over a groundplane, the width of which has been calculated to serve as a 50Ω transmission line. This effectively removes the trace as a source of detuning. The correct trace width can be easily calculated using the information below. The width is based on the desired characteristic impedance, the thickness of the PCB, and its dielectric constant.

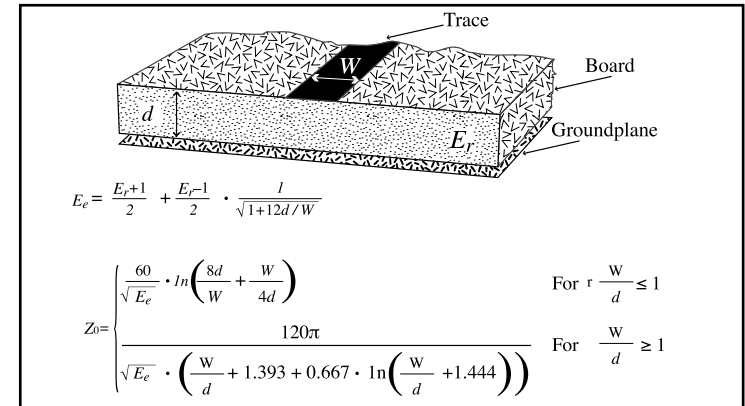

figure 14: Microstrip formulas (E_r = Dielectric constant of pc board material)

Dielectric Constant	Width/Height (W/d)	Effective Dielectric Constant	Characteristic Impedance
4.8	1.8	3.59	50.0
4	2	3.07	51.0
2.55	3	2.12	48.0

3. Depending on the type of antenna being used and duty cycle of incoming data, the output power of the LC module may be higher than FCC regulations allow. The output power of the module is intentionally set high since many designers pair the module with an inefficient antenna in order to realize cost or space savings. Since attenuation is often required it is generally wise to provide for its implementation.

Two methods of attenuation are available using the LC module. First, a resistor may be placed in series with Pad 4 (LVL. ADJ.) to achieve up to a 7 dB reduction in output power. The resistor value is easily determined from the diagram below. Do not exceed the resistance values shown as transmitter instability may result. This method can also be used to reduce transmission range and power consumption.

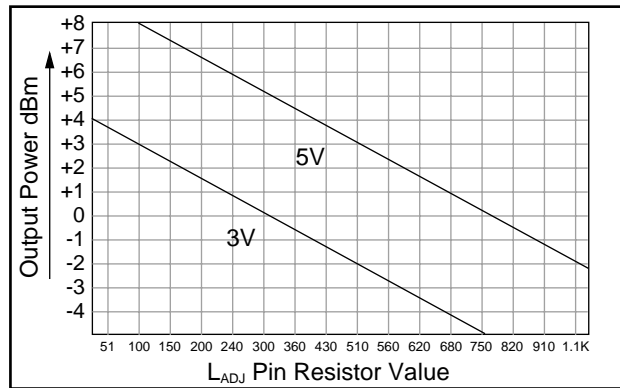

figure 15: Power Output vs. LADJ Pad Resistor Value

Another method commonly used to achieve attenuation, particularly at higher levels, is the use of a T-pad. A T-pad is a 3-resistor network that allows for variable attenuation while maintaining the quality of match to the antenna. It is usually prudent to allow space for the addition of a T-pad. For further details on T-pads please refer to Linx application note #00150.

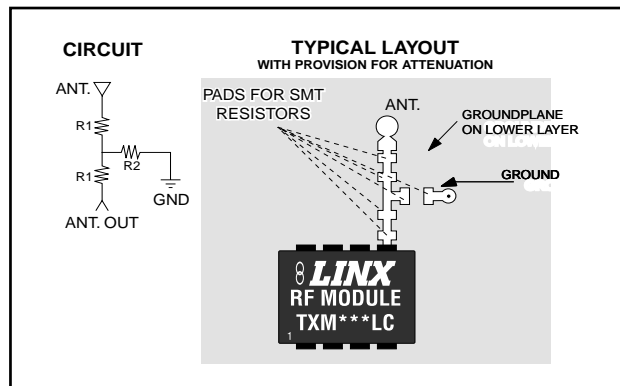

figure 16: Attenuation pad layout

ANTENNA CONSIDERATIONS

The choice of antennas is one of the most critical and often overlooked design considerations. The range, performance, and legality of an RF link is critically dependent upon the type of antenna employed. Proper design and matching of an antenna is a complex task requiring sophisticated test equipment and a strong background in principles of RF propagation. While adequate antenna performance can often be obtained by trial and error methods, you may also want to consider utilizing a professionally designed antenna such as those offered by Linx. Our low-cost antenna line is designed to ensure maximum performance and compliance with Part 15-attachment requirements. The purpose of the following sections is to give you a basic idea of some of the considerations involved in the design and selection of antennas. For a more comprehensive discussion please review Linx applications note #00500 "Antennas: Design, Application, Performance".

THE TRANSMITTER ANTENNA

The transmitter antenna allows RF energy to be efficiently radiated from the output stage into free space. In modular designs such as the LC, a transmitter's output power is often slightly higher than the legal limit. This allows a designer to utilize an inefficient antenna in order to achieve full legal power while meeting size, cost, or cosmetic objectives. For this reason a transmitter's antenna can generally be less efficient than the antenna used on the receiver.

It is usually best to utilize a basic 1/4-wave whip for your initial concept evaluation. Once the prototype product is operating satisfactorily, a production antenna should be selected to meet the cost, size and cosmetic requirements of the product.

Maximum antenna efficiency is always obtained when the antenna is at resonance. If the antenna is too short, capacitive reactance is present; if it is too long, inductive reactance will be present. The indicator of resonance is the minimum point in the VSWR curve. You will see from the following example that antenna (A) is resonant at too low a frequency, indicating excessive length, while antenna (C) is resonant at too high a frequency, indicating the antenna is too short. Antenna (B), however, is "just right."

Antenna resonance should not be confused with antenna impedance. The difference between resonance and impedance is most easily understood by considering the value of VSWR at its lowest point. The lowest point of VSWR indicates the antenna is resonant, but the value of that low point is determined by the quality of the match between the antenna, the transmission line, and the device to which it is attached.

To fully appreciate the importance of an antenna that is both resonant and matched consider that an antenna with a VSWR of 1.5 will effectively transmit approximately 95% of its power while an antenna with a VSWR of 10 will only transmit about 30%.

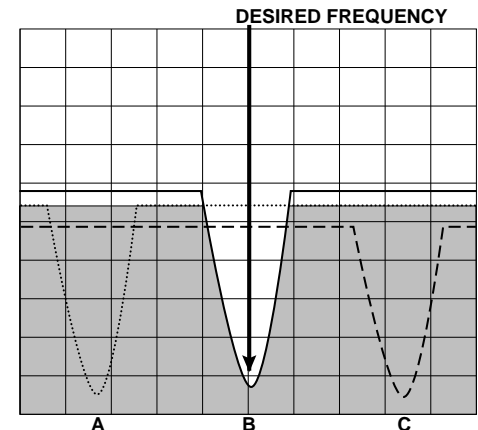

GUIDELINES FOR ACHIEVING OPTIMUM ANTENNA PERFORMANCE

1. Proximity to objects such as a user's hand or body, or metal objects will cause an antenna to detune. For this reason the antenna shaft and tip should be positioned as far away from such objects as possible.

2. Optimum performance will be obtained from a 1/4- or 1/2-wave straight whip mounted at a right angle to the groundplane. In many cases this isn't desirable for practical or ergonomic reasons; thus, an alternative antenna style such as a helical, loop, patch, or base-loaded whip may be utilized.

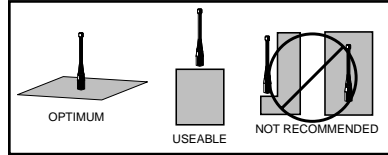

figure 17: Groundplane orientation

3. If an internal antenna is to be used, keep it away from other metal components, particularly large items like transformers, batteries, and PCB tracks and groundplanes. In many cases, the space around the antenna is as important as the antenna itself.

4. In many antenna designs, particularly 1/4-wave whips, the groundplane acts as a counterpoise, forming, in essence, a 1/2-wave dipole. For this reason adequate groundplane area is essential. The groundplane can be a metal case or ground-fill areas on a circuit board. Ideally, the groundplane to be used as counterpoise should have a surface area \geq the overall length of the 1/4-wave radiating element; however, Linx recognizes that this is impossible for most compact designs, so all Linx antennas are characterized using a 4.5" X 4.5" groundplane with the antenna centered and oriented at a 90° angle. Such an orientation is often not practical due to size and configuration constraints. In these instances a designer must make the best use of the area available to create as much groundplane in proximity to the base of the antenna as possible. In instances where the antenna is remotely located or the antenna is not in close proximity to a circuit board plane or grounded metal case, a small metal plate may be fabricated to maximize antenna performance.

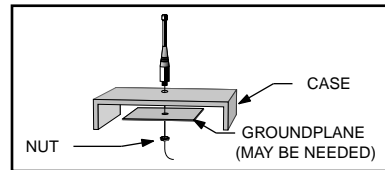

figure 18: External antenna mounting

5. Remove the antenna as far as possible from potential interference sources. There are many possible sources of internally generated interference. Switching power supplies, oscillators, even relays can also be significant sources of potential interference. Remember, the single best weapon against such problems is attention to placement and layout. Filter the module's power supply with a high-frequency bypass capacitor. Place adequate groundplane under all potential sources of noise. Shield noisy board areas whenever practical.

6. In some applications it is advantageous to place the transmitter and its antenna away from the main equipment. This avoids interference problems and allows the antenna to be oriented for optimum RF performance. Always use 50Ω coax such as RG-174 for the remote feed.

COMMON ANTENNA STYLES

There are literally hundreds of antenna styles that can be successfully employed with the LC Series. Following is a brief discussion of the three styles most commonly utilized in compact RF designs. Additional antenna information can be found in Linx application notes #00500, #00100, #00126 and #00140. Linx also offers a broad line of antennas and connectors which offer outstanding performance and cost-effectiveness.

Whip Style

A whip-style monopole antenna provides outstanding overall performance and stability. A low-cost whip can be easily fabricated from wire or rod, but most product designers opt for the improved performance and cosmetic appeal of a professionally made model. To meet this need, Linx offers a wide variety of straight and reduced-height whip-style antennas in permanent and connectorized mounting styles.

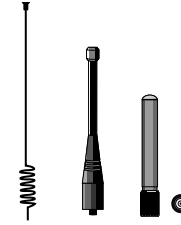

1/4-wave wire lengths for LC frequencies:

315Mhz=8.9"

418Mhz=6.7"

433Mhz=6.5"

The wavelength of the operational frequency determines an antenna's overall length. Since a full wavelength is often quite long, a partial 1/4-wave antenna is normally employed. Its size and natural radiation resistance make it well matched to Linx modules. The proper length for a 1/4-wave antenna can be easily found using the formula below. It is also possible to reduce the overall height of the antenna by using a helical winding. This decreases the antenna's bandwidth but is an excellent way to minimize the antenna's physical size for compact applications.

$$L = \frac{234}{F_{\text{MHz}}}$$

Where:
L=length in feet of quarter-wave length
F=operating frequency in megahertz

Helical Style



A helical antenna is precisely formed from wire or rod. A helical antenna is a good choice for low-cost products requiring average range-performance and internal concealment. A helical can detune badly in proximity to other objects and its bandwidth is quite narrow so care must be exercised in layout and placement.

Loop Style

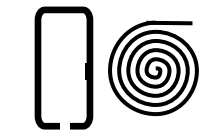

A loop- or trace-style antenna is normally printed directly on a product's PCB. This makes it the most cost-effective of antenna styles. There are a variety of shapes and layout styles which can be utilized. The element can be made self-resonant or externally resonated with discrete components. Despite its cost advantages, PCB antenna styles are generally inefficient and useful only for short-range applications. Loop-style antennas are also very sensitive to changes in layout or substrate dielectric which can introduce consistency issues into the production process. In addition, printed styles initially are difficult to engineer, requiring the use of expensive equipment including a network analyzer. An improperly designed loop will have a high SWR at the desired frequency which can introduce substantial instability in the RF stages.



Linx offers a low-cost planar antenna called the "SPLATCH" which is an excellent alternative to the sometimes problematic PCB trace style. This tiny antenna mounts directly to a product's PCB and requires no testing or tuning. Its design is stable even in compact applications and it provides excellent performance in light of its compact size.

LEGAL CONSIDERATIONS

NOTE: LC Series Modules are designed as component devices which require external components to function. The modules are intended to allow for full Part 15 compliance; however, they are not approved by the FCC or any other agency worldwide. The purchaser understands that approvals may be required prior to the sale or operation of the device, and agrees to utilize the component in keeping with all laws governing its operation in the country of operation.

When working with RF, a clear distinction must be made between what is technically possible and what is legally acceptable in the country where operation is intended. Many manufacturers have avoided incorporating RF into their products as a result of uncertainty and even fear of the approval and certification process. Here at Linx our desire is not only to expedite the design process, but also to assist you in achieving a clear idea of what is involved in obtaining the necessary approvals to market your completed product legally.

In the United States the approval process is actually quite straightforward. The regulations governing RF devices and the enforcement of them are the responsibility of the Federal Communications Commission. The regulations are contained in the Code of Federal Regulations (CFR), Title 47. Title 47 is made up of numerous volumes; however, all regulations applicable to this module are contained in volume 0-19. It is strongly recommended that a copy be obtained from the Government Printing Office in Washington, or from your local government book store. Excerpts of applicable sections are included with Linx evaluation kits or may be obtained from the Linx Technologies web site (www.linxtechnologies.com). In brief, these rules require that any device which intentionally radiates RF energy be approved, that is, tested, for compliance and issued a unique identification number. This is a relatively painless process. Linx offers full EMC pre-compliance testing in our HP/Emco-equipped test center. Final compliance testing is then performed by one of the many independent testing laboratories across the country. Many labs can also provide other certifications the product may require at the same time, such as UL, CLASS A/B, etc. Once your completed product has passed, you will be issued an ID number which is then clearly placed on each product manufactured.

Questions regarding interpretations of the Part 2 and Part 15 rules or measurement procedures used to test intentional radiators, such as the LC modules, for compliance with the Part 15 technical standards, should be addressed to:

Federal Communications Commission
Equipment Authorization Division
Customer Service Branch, MS 1300F2
7435 Oakland Mills Road
Columbia, MD 21046
Tel: (301) 725-1585 / Fax: (301) 344-2050 E-Mail: labinfo@fcc.gov

International approvals are slightly more complex, although many modules are designed to allow all international standards to be met. If you are considering the export of your product abroad, you should contact Linx Technologies to determine the specific suitability of the module to your application.

All Linx modules are designed with the approval process in mind and thus much of the frustration that is typically experienced with a discrete design is eliminated. Approval is still dependent on many factors such as the choice of antennas, correct use of the frequency selected, and physical packaging. While some extra cost and design effort are required to address these issues, the additional usefulness and profitability added to a product by RF makes the effort more than worthwhile.

SURVIVING AN RF IMPLEMENTATION

Adding an RF stage brings an exciting new dimension to any product. It also means that additional effort and commitment will be needed to bring the product successfully to market. By utilizing premade RF modules, such as the LC series, the design and approval process will be greatly simplified. It is still important, however, to have an objective view of the steps necessary to insure a successful RF integration. Since the capabilities of each customer vary widely it is difficult to recommend one particular design path, but most projects follow steps similar to those shown at the right.

In reviewing this sample design path you may notice that Linx offers a variety of services, such as antenna design, and FCC prequalification, that are unusual for a high-volume component manufacturer. These services, along with an exceptional level of technical support, are offered because we recognize that RF is a complex science requiring the highest caliber of products and support. "Wireless Made Simple" is more than just a motto, it's our commitment. By choosing Linx as your RF partner and taking advantage of the resources we offer, you will not only survive implementing RF, you may even find the process enjoyable.

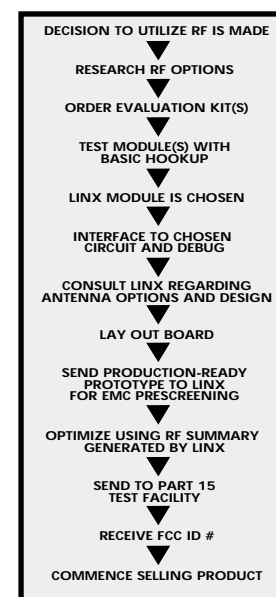

TYPICAL STEPS FOR IMPLEMENTING RF

HELPFUL APPLICATION NOTES FROM LINX

It is not the intention of this manual to address in depth many of the issues that should be considered to ensure that the modules function correctly and deliver the maximum possible performance. As you proceed with your design you may wish to obtain one or more of the following application notes, which address in depth key areas of RF design and application of Linx products.

NOTE #	LINX APPLICATION NOTE TITLE
00232	General considerations for sending data with the LC Series
00500	Antennas: Design, Application, Performance
00130	Modulation techniques for low-cost RF data links
00125	Considerations for operation in the 260 Mhz to 470 Mhz band
00100	RF 101: Information for the RF challenged
00110	Understanding the performance specifications of receivers
00140	The FCC Road: Part 15 from concept to approval
00150	Use and design of T-Attenuation Pads



WIRELESS MADE SIMPLE

U.S. CORPORATE HEADQUARTERS:

LINX TECHNOLOGIES, INC.

575 S.E. ASHLEY PLACE
GRANTS PASS, OR 97526

Phone: (541) 471-6256
FAX: (541) 471-6251
<http://www.linxtechnologies.com>

Disclaimer

Linx Technologies is continually striving to improve the quality and function of its products; for this reason, we reserve the right to make changes without notice. The information contained in this Data Sheet is believed to be accurate as of the time of publication. Specifications are based on representative lot samples. Values may vary from lot to lot and are not guaranteed. Linx Technologies makes no guarantee, warranty, or representation regarding the suitability of any product for use in a specific application. None of these devices is intended for use in applications of a critical nature where the safety of life or property is at risk. The user assumes full liability for the use of product in such applications. Under no conditions will Linx Technologies be responsible for losses arising from the use or failure of the device in any application, other than the repair, replacement, or refund limited to the original product purchase price. Some devices described in this publication are patented. Under no circumstances shall any user be conveyed any license or right to the use or ownership of these patents.

© 1999 by Linx Technologies, Inc. The stylized Linx logo, Linx, and "Wireless Made Simple" are the trademarks of Linx Technologies, Inc.
Printed in U.S.A.