

OBSOLETE PRODUCT

PRODUCT OVERVIEW

Contact Factory for Replacement Model



The WPN20R series is a family of high performance DC/DC converters available in three input voltage ranges of 9-18V, 18-36V and 33-75V. The unit is housed in a space saving aluminum shell and combines low cost with high performance across all line and load conditions. The 300kHz switching frequency and forward converter topology provide excellent performance across all line and load conditions in a space saving package. Other features include: full regulation down to zero load, under voltage lock-out, internal temperature shutdown, soft start, remote on/off and over current protection.

An output trim feature is provided, allowing the user to compensate for long line lengths. The WPN20R Series is assembled using a fully automated process incorporating 100% surface mounted components for increased reliability.

Applications include: Telecom-munications, Battery Powered Systems, Process Control Equipment, Transportation Equipment and Distributed Power Systems.

FEATURES

- Operating Temperature Range: -40°C to +115°C
- Industry Standard Pinout
- Input and Output Filtering
- Low Profile Shell
- Single and Dual Outputs
- High Efficiency
- Remote On/Off Function
- Output Trim Function
- Zero Load Operation
- EN 60950, UL1950, C-UL, VDE Agency Approvals

PRODUCT SELECTION CHART

Specifications are at T_a = +25°C nominal input voltage, rated output current unless otherwise specified.

MODEL*	NOMINAL INPUT VOLTAGE (VDC)	RATED OUTPUT VOLTAGE (VDC)	OUTPUT CURRENT (A)		INPUT CURRENT NOM LOAD	EFFICIENCY (%)
			MIN LOAD	NOM LOAD		
WPN20R12S03	12	3.3	0.0	6.00	2.00	82
WPN20R12S05	12	5.0	0.0	4.00	2.00	84
WPN20R12S12	12	12.0	0.0	1.66	2.00	86
WPN20R12S15	12	15.0	0.0	1.33	2.00	86
WPN20R12D05	12	±5.0	0.0	±2.00	2.00	84
WPN20R12D12	12	±12.0	0.0	±0.83	2.00	86
WPN20R12D15	12	±15.0	0.0	±0.67	2.00	86
WPN20R24S03	24	3.3	0.0	6.00	1.00	83
WPN20R24S05	24	5.0	0.0	4.00	1.00	84
WPN20R24S12	24	12.0	0.0	1.66	1.00	87
WPN20R24S15	24	15.0	0.0	1.33	1.00	87
WPN20R24D05	24	±5.0	0.0	±2.00	1.00	85
WPN20R24D12	24	±12.0	0.0	±0.83	1.00	87
WPN20R24D15	24	±15.0	0.0	±0.67	1.00	87
WPN20R48S03	48	3.3	0.0	6.00	0.50	83
WPN20R48S05	48	5.0	0.0	4.00	0.50	85
WPN20R48S12	48	12.0	0.0	1.66	0.50	88
WPN20R48S15	48	15.0	0.0	1.33	0.50	86
WPN20R48D05	48	±5.0	0.0	±2.00	0.50	85
WPN20R48D12	48	±12.0	0.0	±0.83	0.50	87
WPN20R48D15	48	±15.0	0.0	±0.67	0.50	87

SPECIFICATIONS, ALL MODELS

Specifications are at $T_A = +25^\circ\text{C}$ nominal input voltage, rated output current unless otherwise specified.

	PARAMETER	CONDITIONS	MIN	TYP	MAX	UNITS
OUTPUT	INPUT					
	Voltage Range		9	12	18	V_{DC}
			18	24	36	V_{DC}
			33	48	75	V_{DC}
	Reflected Ripple Current	All Input Ranges			50	mApk-pk
	INPUT CONTROL					
	Temperature Shutdown	Case	105		115	$^\circ\text{C}$
	Temperature Hysteresis			10		$^\circ\text{C}$
	Quiescent Standby Current	Current Into + V_{IN}		8	10	mA
	Undervoltage Control	See Attached Plots				
GENERAL	OUTPUT					
	ISOLATION					
	Rated Voltage		1500			V_{DC}
	Test Voltage	60Hz, 10 Seconds	1500			V_{DC}
	Resistance			10		$G\Omega$
	Capacitance			400		pF
	Leakage Current			30		mArms
	Rated Power				20	W
	Voltage Setpoint Accuracy				± 1.5	%
	Temperature Coefficient				± 0.005	%/ $^\circ\text{C}$
	REGULATION					
	Line Regulation					
	Singles	High Line to Low Line			± 0.1	%
	DUALS	High Line to Low Line			± 0.5	%
	Load Regulation					
	Singles	Mn Load to Nom. Load			± 0.5	%
	DUALS	Mn Load to Nom. Load			± 2.0	%
	 Ripple & Noise					
	Single Outputs	BW = 5Hz to 20MHz		60	100	mVp-p
	Dual Outputs	BW = 5Hz to 20MHz		50	100	mVp-p
	Output Adjust Range	See Attached Plots				
	Short Circuit and Overcurrent Protection	Continuous				
	Max Capacitive Load			550		$\mu\text{F/A}$
	GENERAL					
	Switching Frequency			300		kHz
MTTF per ML-HDBK-217	Circuit Stress Method					
Ground Benign	$T_a = +25^\circ$ Unmodified Database		1,400,000		Hr	
Package Weight			32		g	
Moisture Sensitivity Level (MSL)	as per IPC/JEDEC J-STD-20		2			
TEMPERATURE						
Specification	Case	-40		+ 85	$^\circ\text{C}$	
Operation	Case	-40		+ 85	$^\circ\text{C}$	
Storage		-55		+125	$^\circ\text{C}$	

REMOTE ON/OFF CONTROL

Logic Compatibility Open Collector TTL
 EC On Open Circuit
 EC Off $< 0.7\text{V}$
 Shutdown Idle Current 8mA

ORDERING INFORMATION

Device Family **WPN20R XXYZZ**
 20W Regulated DC/DC Unit

Model Number _____
 xx = Input Range, e.g. 48V
 y = Number of Outputs (S=single; D=dual)
 zz = Output Voltage, e.g. '05' for 5V

MECHANICAL

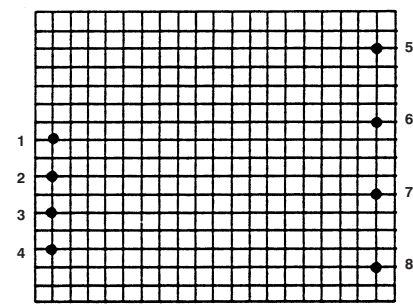
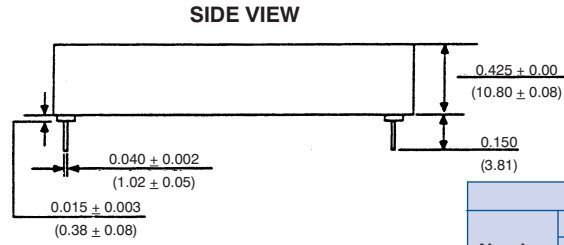
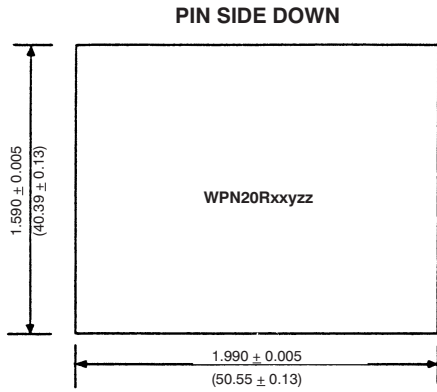

PIN CONNECTIONS		
Number	Pin Function	
	Singles	Duals
1	+VIN	+VIN
2	-VIN	-VIN
3	NO PIN	NO PIN
4	Remote On/Off	Remote On/Off
5	NO PIN	+VOUT
6	+VOUT	COMMON
7	-VOUT	-VOUT
8	TRIM	TRIM

NOTES:
 All dimensions are in inches (millimeters).
 GRID: 0.100 inches (2.54 millimeters)
 Pin Placement: Tolerance: ±0.015
 Marked with: specific model ordered, date code, job code.
MATERIAL: Units are encapsulated in a low thermal resistance molding compound which has excellent chemical resistance, wide operating temperature range, and good electrical properties under high humidity environments. The encapsulant and outer shell of the unit have UL94V-0 ratings. Lead material is phosphor bronze; lead finish is matte Sn (100-300 micro-inches) over Ni (5-40 microinches).

SIMPLIFIED CIRCUIT DIAGRAM

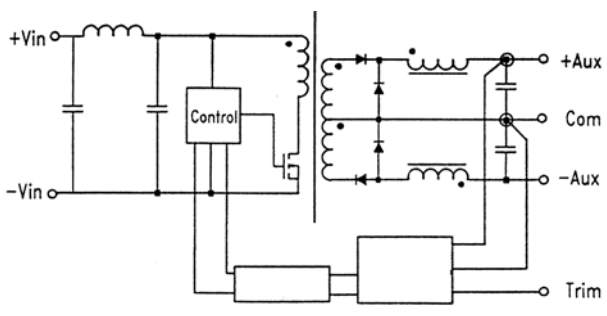

THERMAL DERATING CURVE

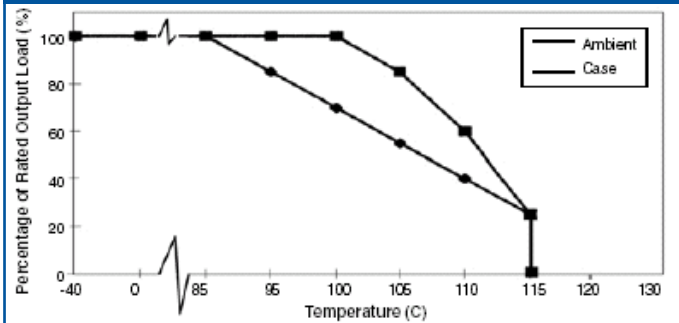

HYSTERESIS GRAPH

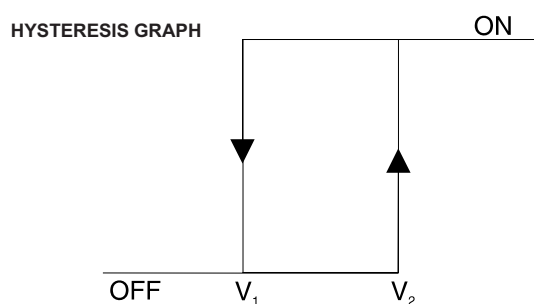

Undervoltage Lockout Threshold Voltages

Nominal Input Voltage Range	Shutdown Low Voltage (V1) OFF	Shutdown High Voltage (V2) ON
12	7	8.8
24	15.5	17
48	30	33

Specifications typical at TA=25°C, rated output current.

PERFORMANCE GRAPHS

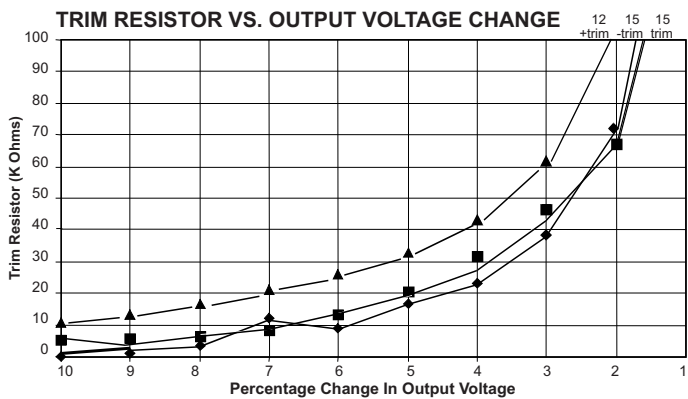
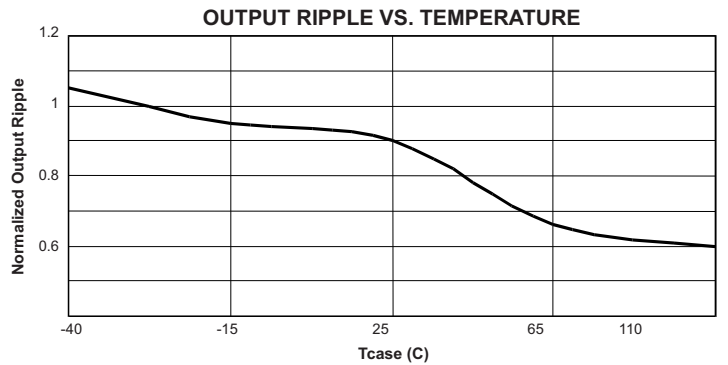
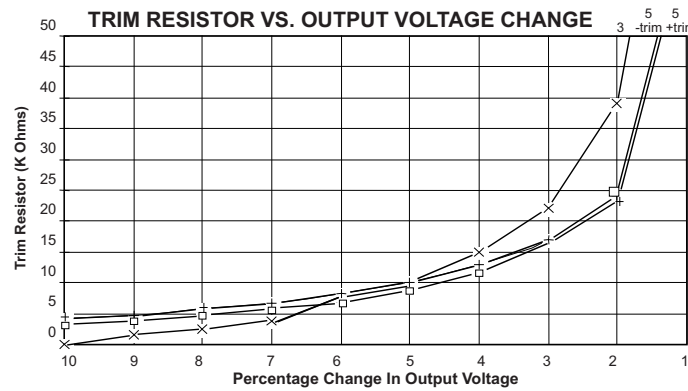
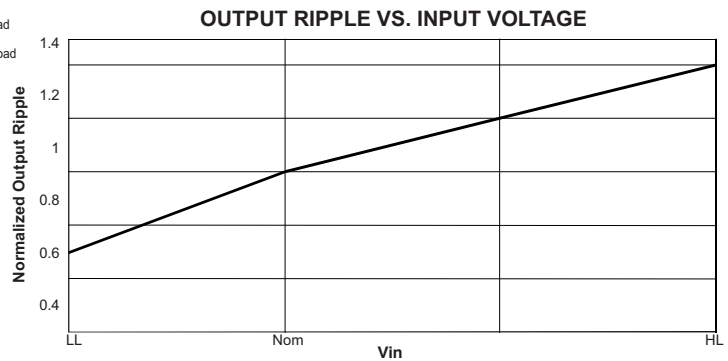
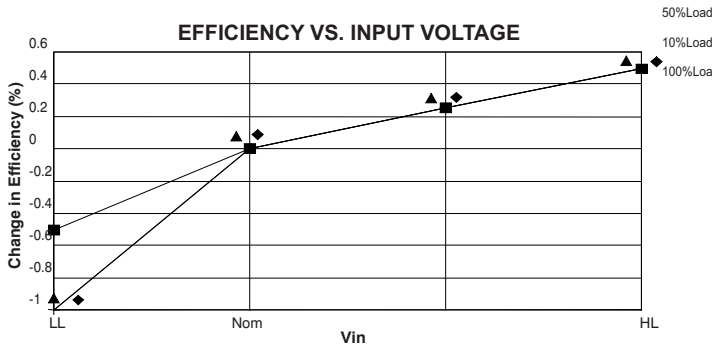
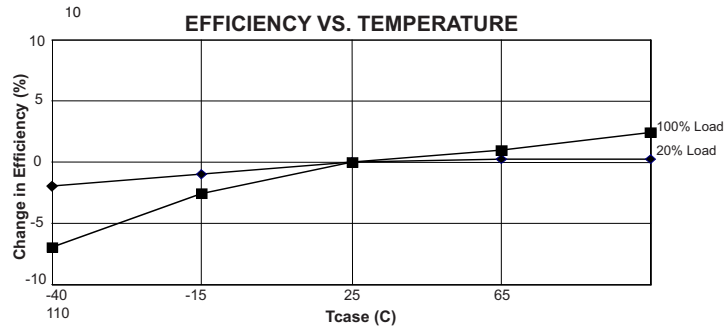
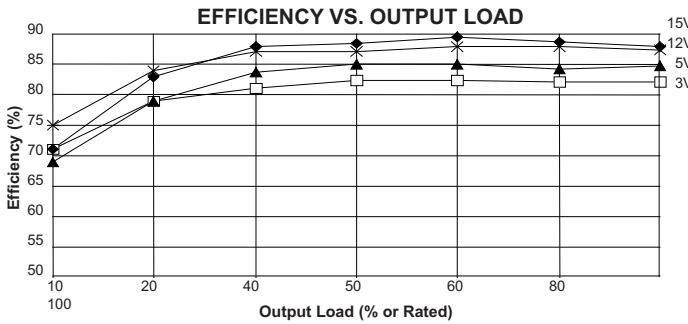

THROUGH-HOLE SOLDERING INFORMATION

These devices are intended for wave soldering or manual soldering. **They are not intended to be subject to surface mount processes under any circumstances.**

The normal wave soldering process can be used with these devices where the device is subjected to a maximum wave temperature of 260°C for a period of no more than 10 seconds. Within this time and temperature range, internal temperatures within the converter will not exceed 175°C. Care should be taken to control manual soldering limits identical to that of wave soldering.

Murata Power Solutions, Inc.

11 Cabot Boulevard, Mansfield, MA 02048-1151 U.S.A.

Tel: (508) 339-3000 (800) 233-2765 Fax: (508) 339-6356

www.murata-ps.com email: **sales@murata-ps.com** **ISO 9001 REGISTERED**
03/06/08

Murata Power Solutions, Inc. makes no representation that the use of its products in the circuits described herein, or the use of other technical information contained herein, will not infringe upon existing or future patent rights. The descriptions contained herein do not imply the granting of licenses to make, use, or sell equipment constructed in accordance therewith. Specifications are subject to change without notice.
© 2008 Murata Power Solutions, Inc.

- USA:** Tucson (Az), Tel: (800) 547 2537, email: sales@murata-ps.com
Canada: Toronto, Tel: (866) 740 1232, email: toronto@murata-ps.com
UK: Milton Keynes, Tel: +44 (0)1908 615232, email: mk@murata-ps.com
France: Montigny Le Bretonneux, Tel: +33 (0)1 34 60 01 01, email: france@murata-ps.com
Germany: München, Tel: +49 (0)89-544334-0, email: munich@murata-ps.com
Japan: Tokyo, Tel: 3-3779-1031, email: sales_tokyo@murata-ps.com
Osaka, Tel: 6-6354-2025, email: sales_osaka@murata-ps.com
Website: www.murata-ps.jp
China: Shanghai, Tel: +86 215 027 3678, email: shanghai@murata-ps.com
Guangzhou, Tel: +86 208 221 8066, email: guangzhou@murata-ps.com