

### Allows Cleaning After Soldering with Alcohol Solvents

- Internal sealed construction allows immersion cleaning with alcohol solvents after soldering.
- Thin, compact construction in both 12 x 12 mm and 6 x 6 mm sizes.
- Snap-action contact construction for a positive click action.
- Available with ground terminals for protection against static electricity.
- Sealed construction also provides high reliability in dusty environments.

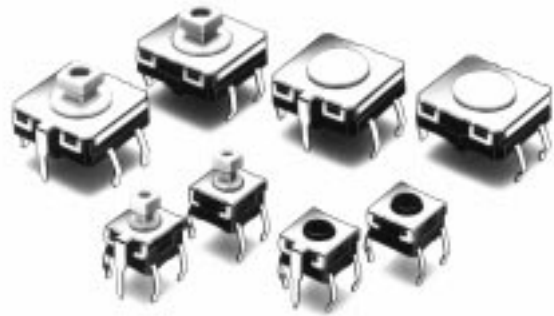

## Ordering Information

### Model Number Legend:

**B3W-**□□□□□  
1 2 3 4 5

- Size**
  - 1: 6 mm x 6 mm
  - 4: 12 mm x 12 mm
- Ground terminal**
  - 0: Without ground terminal
  - 1: With ground terminal
- Plunger**
  - 0: Flat
  - 5: Projected
- Operating force (OF)**
  - 0: B3W-1□□□ models: 1.57 N {160 gf}
  - B3W-4□□□ models: 1.96 N {200 gf}
  - 2: 2.25 N {230 gf}
  - 5: B3W-4□□□ models: 3.43 N {350 gf}
- Shipment package**
  - None: Bag
  - S: Stick

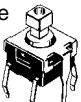
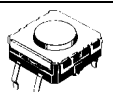
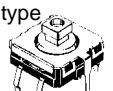
Type	Plunger	Operating force (OF)		Without ground terminal		With ground terminal	
				Bags	Sticks*	Bags	Sticks*
6 x 6 mm B3W-1□□□	Flat type 	Standard force	1.57 N {160 gf}	B3W-1000	B3W-1000S	B3W-1100	B3W-1100S
		High-force	2.25 N {230 gf}	B3W-1002	B3W-1002S	B3W-1102	B3W-1102S
	Projected type 	Standard force	1.57 N {160 gf}	B3W-1050	B3W-1050S	B3W-1150	B3W-1150S
		High-force	2.25 N {230 gf}	B3W-1052	B3W-1052S	B3W-1152	B3W-1152S
12 x 12 mm B3W-4□□□	Flat type 	Standard force	1.96 N {200 gf}	B3W-4000	B3W-4000S	B3W-4100	B3W-4100S
		High-force	3.43 N {350 gf}	B3W-4005	B3W-4005S	B3W-4105	B3W-4105S
	Projected type 	Standard force	1.96 N {200 gf}	B3W-4050	B3W-4050S	B3W-4150	B3W-4150S
		High-force	3.43 N {350 gf}	B3W-4055	B3W-4055S	B3W-4155	B3W-4155S

\*Orders must be made in multiples of the quantity per stick as shown below.

Size	Without ground terminal	With ground terminal
6 x 6 mm	80/stick	75/stick
12 x 12 mm	45/stick	40/stick

## ■ Accessories (Order Separately)

Special Key Tops are available for projected Switch models. See page 52.

## Nomenclature

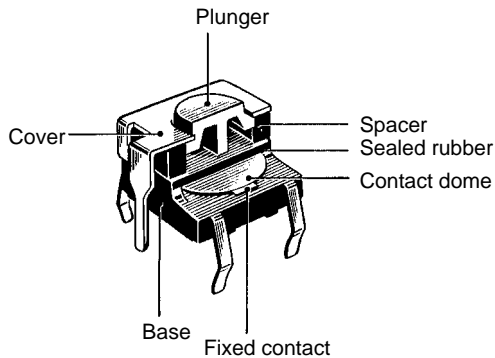

## Specifications

### ■ Ratings/Characteristics

<b>Switching capacity</b>	1 to 50 mA, 5 to 24 VDC (resistive load)
<b>Contact configuration</b>	SPST-NO
<b>Contact resistance</b>	100 mΩ max. (initial value) (rated: 1 mA, 5 VDC)
<b>Insulation resistance</b>	100 MΩ min. (at 250 VDC)
<b>Dielectric strength</b>	500 VAC, 50/60 Hz for 1 min
<b>Bounce time</b>	5 ms max.
<b>Vibration resistance</b>	Malfunction: 10 to 55 Hz, 1.5 mm double amplitude
<b>Shock resistance</b>	Destruction: 1,000 m/s <sup>2</sup> {approx. 100 G} max. Malfunction: 100 m/s <sup>2</sup> {approx. 10 G} max.
<b>Life expectancy</b>	B3W-1□□□: Standard force: 1,000,000 operations min. High-force: 300,000 operations min. B3W-4□□□: Standard force: 3,000,000 operations min. High-force: 1,000,000 operations min.
<b>Ambient temperature</b>	-25°C to 70°C (with no icing)
<b>Ambient humidity</b>	35% to 85%
<b>Weight</b>	6 x 6 mm: approx. 0.3 g, 12 x 12: approx. 1.00 g

# Engineering Data

**Operating Force vs. Stroke (Typical)**  
B3W-1□□□

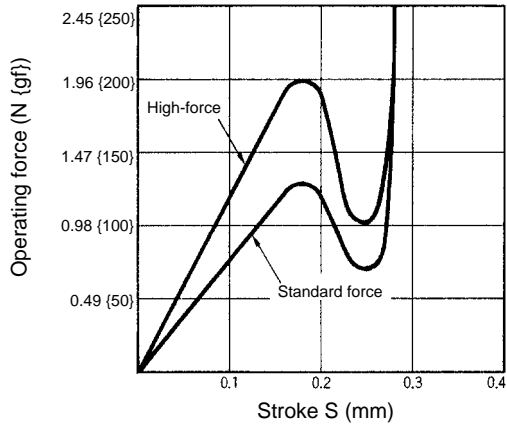

B3W-4□□□

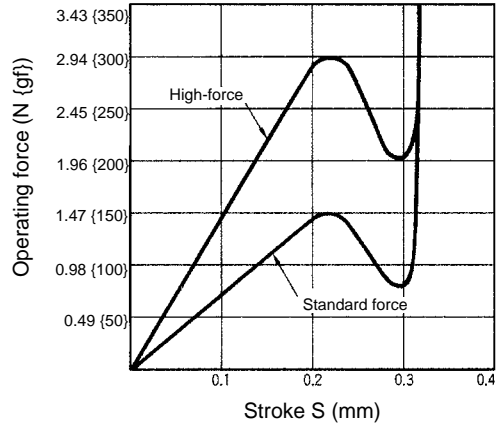

## Dimensions

- Note:**
1. All units are in millimeters unless otherwise indicated. Unless otherwise specified, a tolerance of  $\pm 0.4$  mm applies to all dimensions.
  2. No terminal numbers are indicated on the Switches. The numbers used for terminals in the following graphics are indicated in the "Bottom View" diagram below. In this diagram, the Switch is rotated so that the terminals are on the right and left-hand sides, and the OMRON logo appears the right way up.

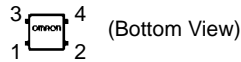

### 6 x 6 mm Models

**Flat Plunger Type (without Ground Terminal)**  
B3W-1000, -1002

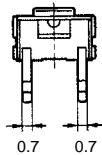
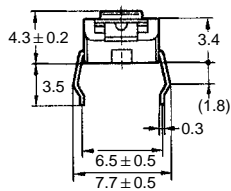
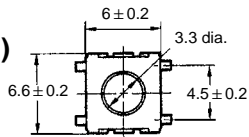
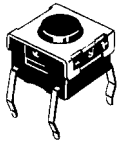

**PCB Mounting (Top View) (Single-sided PCB, t=1.6)**

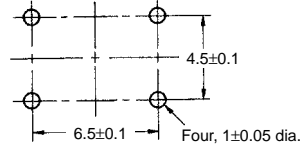

**Terminal Arrangement /Internal Connections (Top View)**

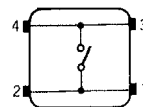

**Flat Plunger Type (with Ground Terminal)**  
B3W-1100, -1102

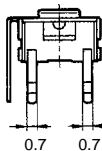
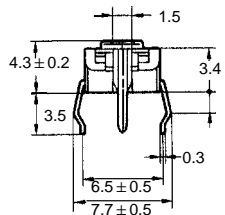
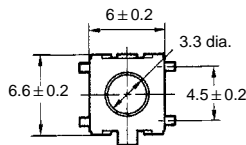
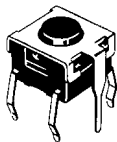

**PCB Mounting (Top View) (Single-sided PCB, t=1.6)**

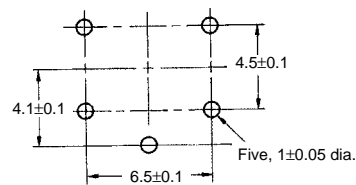

**Terminal Arrangement /Internal Connections (Top View)**

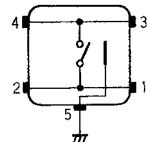

**Projected Plunger Type  
(without Ground Terminal)  
B3W-1050, -1052**

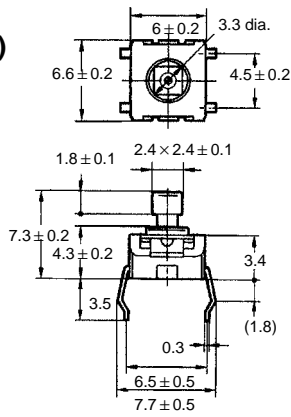
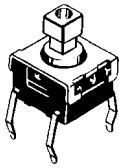

**PCB Mounting  
(Top View)  
(Single-sided  
PCB,  $t=1.6$ )**

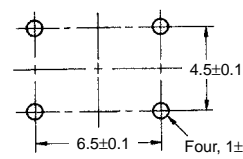

**Terminal Arrangement  
/Internal Connections  
(Top View)**

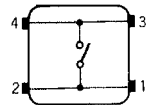

**Projected Plunger Type  
(with Ground Terminal)  
B3W-1150, -1152**

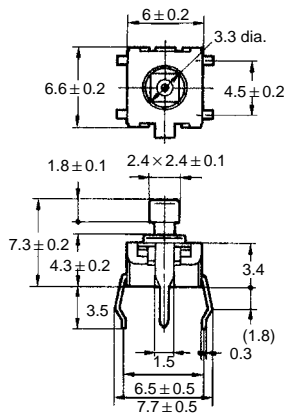
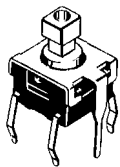

**PCB Mounting  
(Top View)  
(Single-sided  
PCB,  $t=1.6$ )**

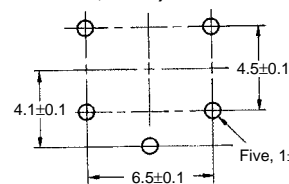

**Terminal Arrangement  
/Internal Connections  
(Top View)**

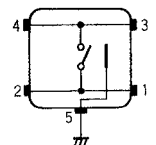

**Operating Characteristics**

Item	B3W-1□□0	B3W-1□□2
Operating force (OF)	1.57 N {160 gf} max.	2.25 N {230 gf} max.
Releasing force (RF)	0.2 N {20 gf} min.	0.49 N {50 gf} min.
Pretravel (PT)	$0.25^{+0.2}_{-0.1}$ mm	

**12 x 12 mm Models**

**Flat Plunger Type  
(without Ground Terminal)  
B3W-4000, -4005**

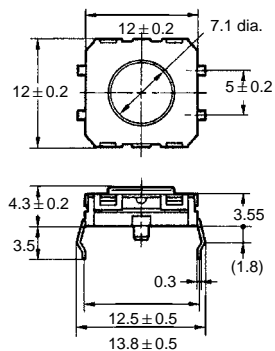
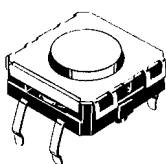

**PCB Mounting  
(Top View)  
(Single-sided  
PCB,  $t=1.6$ )**

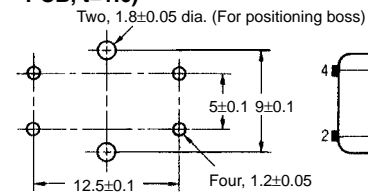

**Terminal Arrangement  
/Internal Connections  
(Top View)**

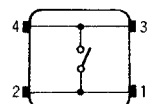

**Flat Plunger Type  
(with Ground Terminal)  
B3W-4100, -4105**

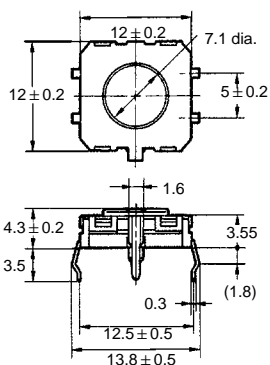
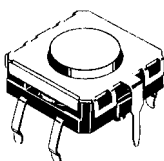

**PCB Mounting  
(Top View)  
(Single-sided  
PCB,  $t=1.6$ )**

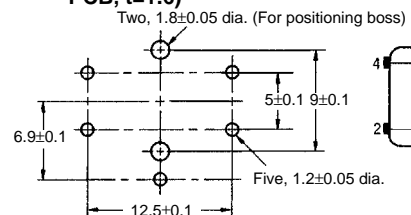

**Terminal Arrangement  
/Internal Connections  
(Top View)**

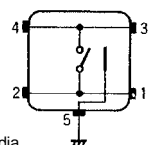

**Projected Plunger Type  
(without Ground Terminal)  
B3W-4050, -4055**

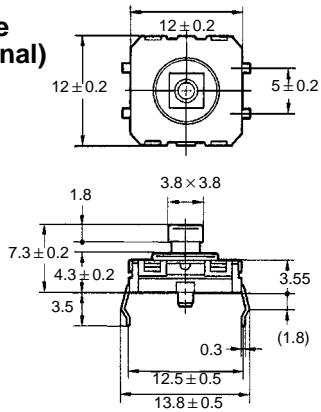
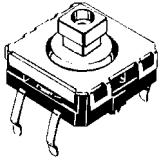

**PCB Mounting  
(Top View)  
(Single-sided  
PCB, t=1.6)**

**Terminal Arrangement  
/Internal Connections  
(Top View)**

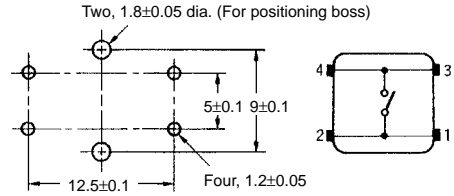

**Projected Plunger Type  
(with Ground Terminal)  
B3W-4150, -4155**

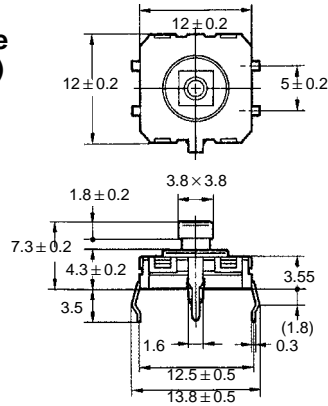
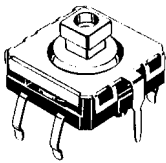

**PCB Mounting  
(Top View)  
(Single-sided  
PCB, t=1.6)**

**Terminal Arrangement  
/Internal Connections  
(Top View)**

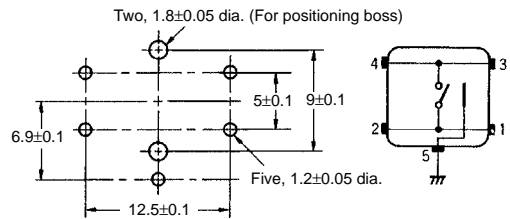

**Operating Characteristics**

Item	B3W-4□□0	B3W-4□□5
Operating force (OF)	1.96 N {200 gf} max.	3.43 N {350 gf} max.
Releasing force (RF)	0.29 N {30 gf} min.	0.49 N {50 gf} min.
Pretravel (PT)	$0.3^{+0.2}/_{-0.1}$ mm	

**Precautions**

**Operation**

Do not apply additional force to the plunger once it has stopped.

**PCB**

The Switch is designed for a 1.6-mm-thick, single-sided PCB. Using PCBs that are different in thickness or using double-sided, through-hole PCBs may result in loose mounting, improper insertion, or poor heat resistance in soldering. Whether these problems arise or not will be depend on the type of holes, patterns, etc. Therefore, it is recommended that a verification test is conducted before use.

**Soldering**

The Switch can be soldered automatically or manually.

The automatic soldering of the Switch on a 1.6-mm-thick, single-sided PCB must be completed within five seconds at a soldering temperature of 260°C maximum.

The manual soldering of the Switch on a 1.6-mm-thick, single-sided PCB must be completed within three seconds at a soldering iron tip temperature of 350°C maximum.

**Cleaning**

Clean with alcohol solvents. Do not use chlorine solvents or water. When cleaning in multiple-tank systems, do not clean for more than 1 minute at a time or for more than 3 minutes total.

Do not apply external force to the Switch during cleaning.

Do not clean immediately after soldering. Allow components to stand for at least 3 minutes before cleaning if possible.

**ALL DIMENSIONS SHOWN ARE IN MILLIMETERS.**

To convert millimeters into inches, multiply by 0.03937. To convert grams into ounces, multiply by 0.03527.