

# ESD/Surge Protection Diode Array

## Bi-directional ESD Protection for High-Speed Data Line



ON Semiconductor®

[www.onsemi.com](http://www.onsemi.com)

### SMDA05C Series

The SMDA05C surge protection series is designed to protect equipment attached to up to four high speed communication lines from ESD, EFT and surge.

#### Features

- SO-8 Package
- Peak Power – 300 W 8 x 20  $\mu$ s
- ESD Rating:  
IEC 61000-4-2 (ESD)  $\pm$ 15 kV (Air)  $\pm$ 8 kV (Contact)  
IEC 61000-4-4 (EFT) 40 A (5/50 ns)  
IEC 61000-4-5 (Surge) 12 A (8/20  $\mu$ s)
- UL Flammability Rating of 94 V-0
- These Devices are Pb-Free, Halogen Free/BFR Free and are RoHS Compliant

#### Typical Applications

- High Speed Communication Line Protection
- Data and I/O Lines
- Microprocessor Based Equipment
- LAN/WAN Equipment
- Servers
- Notebook and Desktop PC
- Serial and Parallel Ports
- Peripherals

#### MAXIMUM RATINGS

Rating	Symbol	Value	Unit
Peak Power Dissipation 8 x 20 $\mu$ s @ T <sub>A</sub> = 25°C (Note 1)	P <sub>pk</sub>	300	W
Junction and Storage Temperature Range	T <sub>J</sub> , T <sub>stg</sub>	-55 to +150	°C
Lead Solder Temperature – Maximum 10 Seconds Duration	T <sub>L</sub>	260	°C

1. Non-repetitive current pulse 8 x 20  $\mu$ s exponential decay waveform.

### SO-8 ESD AND SURGE PROTECTOR 300 WATTS PEAK POWER

#### PIN CONFIGURATION AND SCHEMATIC

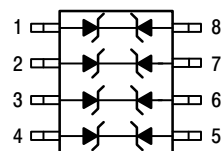

SO-8  
CASE 751-07

#### MARKING DIAGRAM

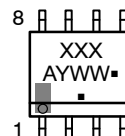

A = Assembly Location  
Y = Year  
WW = Work Week  
▪ = Pb-Free Package

(Note: Microdot may be in either location)

#### ORDERING INFORMATION

See detailed ordering, marking and shipping information in the package dimensions section on page 3 of this data sheet.

## SMDA05C Series

### SMDA05C ELECTRICAL CHARACTERISTICS

Characteristic	Symbol	Min	Typ	Max	Unit
Reverse Working Voltage	$V_{RWM}$	-	-	5.0	V
Reverse Breakdown Voltage @ $I_t = 1.0$ mA	$V_{BR}$	6.0	-	-	V
Reverse Leakage Current @ $V_{RWM} = 5$ Volts	$I_R$	N/A	-	20	$\mu$ A
Maximum Clamping Voltage @ $I_{PP} = 1.0$ A, 8 x 20 $\mu$ s	$V_C$	N/A	-	9.8	V
Maximum Clamping Voltage @ $I_{PP} = 5.0$ A, 8 x 20 $\mu$ s	$V_C$	N/A	-	11	V
Maximum Peak Pulse Current, 8 x 20 $\mu$ s	$I_{PP}$	-	-	17	A
Junction Capacitance @ $V_R = 0$ V, $f = 1$ MHz	$C_J$	-	-	350	pF

### SMDA12C ELECTRICAL CHARACTERISTICS

Characteristic	Symbol	Min	Typ	Max	Unit
Reverse Working Voltage	$V_{RWM}$	-	-	12	V
Reverse Breakdown Voltage @ $I_t = 1.0$ mA	$V_{BR}$	13.3	-	-	V
Reverse Leakage Current @ $V_{RWM} = 12$ Volts	$I_R$	N/A	-	1.0	$\mu$ A
Maximum Clamping Voltage @ $I_{PP} = 1.0$ A, 8 x 20 $\mu$ s	$V_C$	N/A	-	19	V
Maximum Clamping Voltage @ $I_{PP} = 5.0$ A, 8 x 20 $\mu$ s	$V_C$	N/A	-	24	V
Maximum Peak Pulse Current, 8 x 20 $\mu$ s	$I_{PP}$	-	-	12	A
Junction Capacitance @ $V_R = 0$ V, $f = 1$ MHz	$C_J$	-	-	120	pF

### SMDA15C ELECTRICAL CHARACTERISTICS

Characteristic	Symbol	Min	Typ	Max	Unit
Reverse Working Voltage	$V_{RWM}$	-	-	15	V
Reverse Breakdown Voltage @ $I_t = 1.0$ mA	$V_{BR}$	16.7	-	-	V
Reverse Leakage Current @ $V_{RWM} = 15$ Volts	$I_R$	N/A	-	1.0	$\mu$ A
Maximum Clamping Voltage @ $I_{PP} = 1.0$ A, 8 x 20 $\mu$ s	$V_C$	N/A	-	24	V
Maximum Clamping Voltage @ $I_{PP} = 5.0$ A, 8 x 20 $\mu$ s	$V_C$	N/A	-	30	V
Maximum Peak Pulse Current, 8 x 20 $\mu$ s	$I_{PP}$	-	-	10	A
Junction Capacitance @ $V_R = 0$ V, $f = 1$ MHz	$C_J$	-	-	75	pF

### SMDA24C ELECTRICAL CHARACTERISTICS

Characteristic	Symbol	Min	Typ	Max	Unit
Reverse Working Voltage	$V_{RWM}$	-	-	24	V
Reverse Breakdown Voltage @ $I_t = 1.0$ mA	$V_{BR}$	26.7	-	-	V
Reverse Leakage Current @ $V_{RWM} = 24$ Volts	$I_R$	N/A	-	1.0	$\mu$ A
Maximum Clamping Voltage @ $I_{PP} = 1.0$ A, 8 x 20 $\mu$ s	$V_C$	N/A	-	43	V
Maximum Clamping Voltage @ $I_{PP} = 5.0$ A, 8 x 20 $\mu$ s	$V_C$	N/A	-	55	V
Maximum Peak Pulse Current, 8 x 20 $\mu$ s	$I_{PP}$	-	-	5.0	A
Junction Capacitance @ $V_R = 0$ V, $f = 1$ MHz	$C_J$	-	-	50	pF

## SMDA05C Series

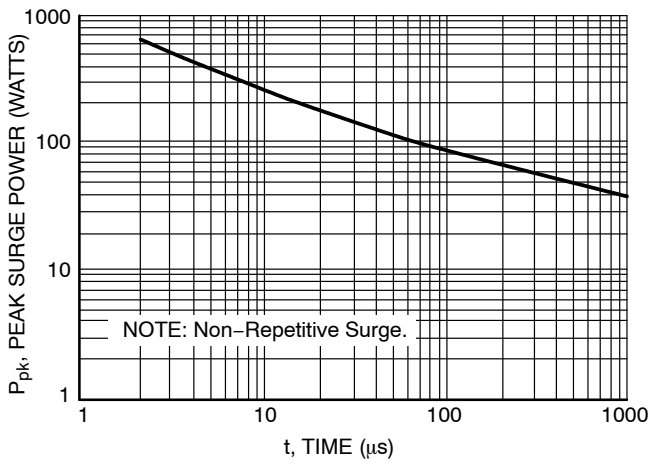

**Figure 1. Pulse Width**

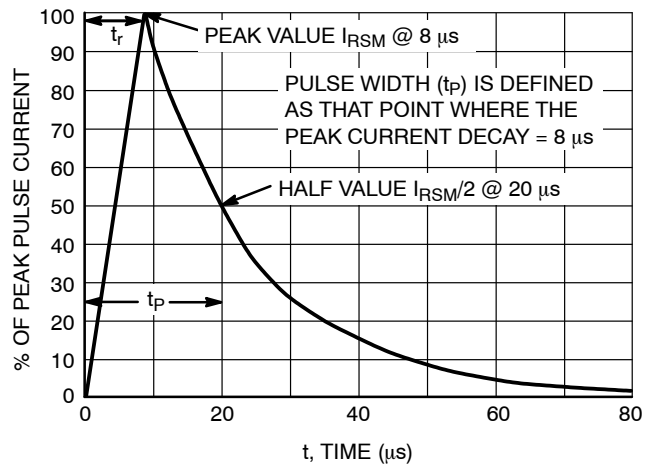

**Figure 2.  $8 \times 20 \mu s$  Pulse Waveform**

### ORDERING INFORMATION

Device	Marking	Package	Shipping†
SMDA05CDR2G	AAA	SO-8 (Pb-Free)	2500 / Tape & Reel
SMDA12CDR2G	AAC	SO-8 (Pb-Free)	2500 / Tape & Reel
SMDA15CDR2G	AAD	SO-8 (Pb-Free)	2500 / Tape & Reel
SMDA24CDR2G	AAE	SO-8 (Pb-Free)	2500 / Tape & Reel

†For information on tape and reel specifications, including part orientation and tape sizes, please refer to our Tape and Reel Packaging Specifications Brochure, BRD8011/D.

# MECHANICAL CASE OUTLINE PACKAGE DIMENSIONS

ON Semiconductor®

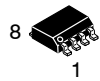

SCALE 1:1

SOIC-8 NB  
CASE 751-07  
ISSUE AK

DATE 16 FEB 2011

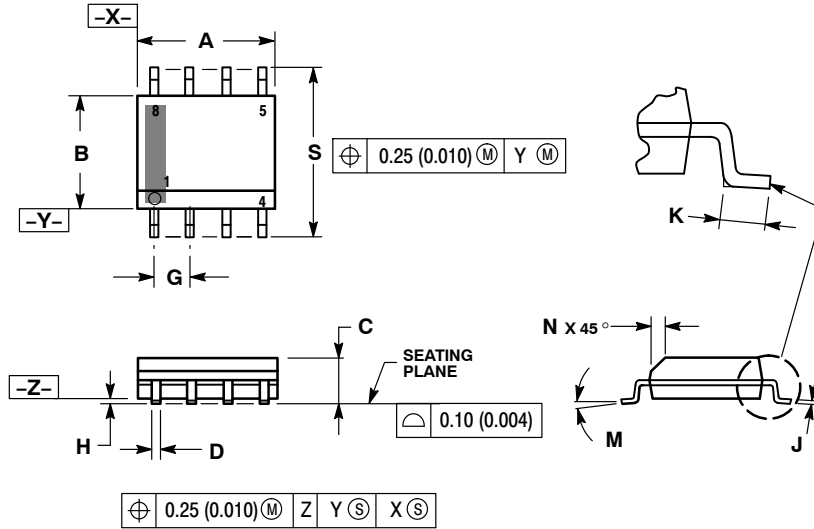

- NOTES:
1. DIMENSIONING AND TOLERANCING PER ANSI Y14.5M, 1982.
  2. CONTROLLING DIMENSION: MILLIMETER.
  3. DIMENSION A AND B DO NOT INCLUDE MOLD PROTRUSION.
  4. MAXIMUM MOLD PROTRUSION 0.15 (0.006) PER SIDE.
  5. DIMENSION D DOES NOT INCLUDE DAMBAR PROTRUSION. ALLOWABLE DAMBAR PROTRUSION SHALL BE 0.127 (0.005) TOTAL IN EXCESS OF THE D DIMENSION AT MAXIMUM MATERIAL CONDITION.
  6. 751-01 THRU 751-06 ARE OBSOLETE. NEW STANDARD IS 751-07.

DIM	MILLIMETERS		INCHES	
	MIN	MAX	MIN	MAX
A	4.80	5.00	0.189	0.197
B	3.80	4.00	0.150	0.157
C	1.35	1.75	0.053	0.069
D	0.33	0.51	0.013	0.020
G	1.27 BSC		0.050 BSC	
H	0.10	0.25	0.004	0.010
J	0.19	0.25	0.007	0.010
K	0.40	1.27	0.016	0.050
M	0°	8°	0°	8°
N	0.25	0.50	0.010	0.020
S	5.80	6.20	0.228	0.244

### SOLDERING FOOTPRINT\*

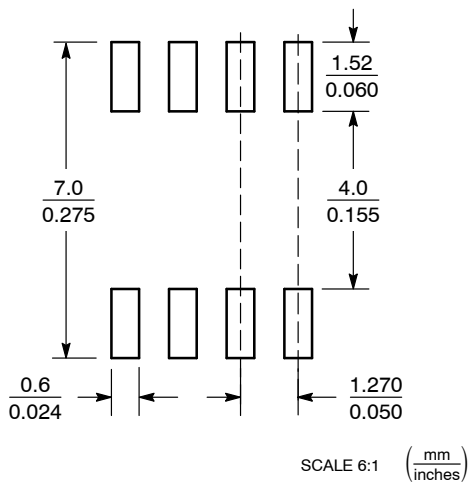

\*For additional information on our Pb-Free strategy and soldering details, please download the ON Semiconductor Soldering and Mounting Techniques Reference Manual, SOLDERRM/D.

### GENERIC MARKING DIAGRAM\*

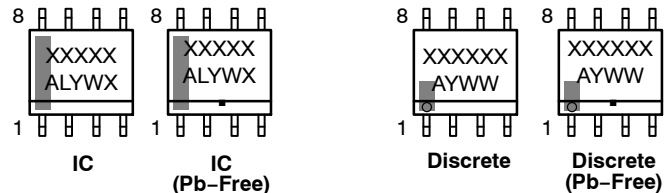

XXXXXX = Specific Device Code  
 A = Assembly Location  
 L = Wafer Lot  
 Y = Year  
 W = Work Week  
 ■ = Pb-Free Package

XXXXXX = Specific Device Code  
 A = Assembly Location  
 Y = Year  
 WW = Work Week  
 ■ = Pb-Free Package

\*This information is generic. Please refer to device data sheet for actual part marking. Pb-Free indicator, "G" or microdot "•", may or may not be present. Some products may not follow the Generic Marking.

STYLES ON PAGE 2

DOCUMENT NUMBER:	98ASB42564B	Electronic versions are uncontrolled except when accessed directly from the Document Repository. Printed versions are uncontrolled except when stamped "CONTROLLED COPY" in red.
DESCRIPTION:	SOIC-8 NB	PAGE 1 OF 2

ON Semiconductor and ON are trademarks of Semiconductor Components Industries, LLC dba ON Semiconductor or its subsidiaries in the United States and/or other countries. ON Semiconductor reserves the right to make changes without further notice to any products herein. ON Semiconductor makes no warranty, representation or guarantee regarding the suitability of its products for any particular purpose, nor does ON Semiconductor assume any liability arising out of the application or use of any product or circuit, and specifically disclaims any and all liability, including without limitation special, consequential or incidental damages. ON Semiconductor does not convey any license under its patent rights nor the rights of others.

**SOIC-8 NB**  
**CASE 751-07**  
**ISSUE AK**

DATE 16 FEB 2011

- |  |   |   |   |
|--|---|---|---|
| <p><b>STYLE 1:</b><br/> PIN 1. EMITTER<br/> 2. COLLECTOR<br/> 3. COLLECTOR<br/> 4. EMITTER<br/> 5. EMITTER<br/> 6. BASE<br/> 7. BASE<br/> 8. EMITTER</p>   | <p><b>STYLE 2:</b><br/> PIN 1. COLLECTOR, DIE, #1<br/> 2. COLLECTOR, #1<br/> 3. COLLECTOR, #2<br/> 4. COLLECTOR, #2<br/> 5. BASE, #2<br/> 6. EMITTER, #2<br/> 7. BASE, #1<br/> 8. EMITTER, #1</p>               | <p><b>STYLE 3:</b><br/> PIN 1. DRAIN, DIE #1<br/> 2. DRAIN, #1<br/> 3. DRAIN, #2<br/> 4. DRAIN, #2<br/> 5. GATE, #2<br/> 6. SOURCE, #2<br/> 7. GATE, #1<br/> 8. SOURCE, #1</p>                            | <p><b>STYLE 4:</b><br/> PIN 1. ANODE<br/> 2. ANODE<br/> 3. ANODE<br/> 4. ANODE<br/> 5. ANODE<br/> 6. ANODE<br/> 7. ANODE<br/> 8. COMMON CATHODE</p>   |
| <p><b>STYLE 5:</b><br/> PIN 1. DRAIN<br/> 2. DRAIN<br/> 3. DRAIN<br/> 4. DRAIN<br/> 5. GATE<br/> 6. GATE<br/> 7. SOURCE<br/> 8. SOURCE</p>   | <p><b>STYLE 6:</b><br/> PIN 1. SOURCE<br/> 2. DRAIN<br/> 3. DRAIN<br/> 4. SOURCE<br/> 5. SOURCE<br/> 6. GATE<br/> 7. GATE<br/> 8. SOURCE</p>  | <p><b>STYLE 7:</b><br/> PIN 1. INPUT<br/> 2. EXTERNAL BYPASS<br/> 3. THIRD STAGE SOURCE<br/> 4. GROUND<br/> 5. DRAIN<br/> 6. GATE 3<br/> 7. SECOND STAGE Vd<br/> 8. FIRST STAGE Vd</p>                    | <p><b>STYLE 8:</b><br/> PIN 1. COLLECTOR, DIE #1<br/> 2. BASE, #1<br/> 3. BASE, #2<br/> 4. COLLECTOR, #2<br/> 5. COLLECTOR, #2<br/> 6. EMITTER, #2<br/> 7. EMITTER, #1<br/> 8. COLLECTOR, #1</p>                              |
| <p><b>STYLE 9:</b><br/> PIN 1. EMITTER, COMMON<br/> 2. COLLECTOR, DIE #1<br/> 3. COLLECTOR, DIE #2<br/> 4. EMITTER, COMMON<br/> 5. EMITTER, COMMON<br/> 6. BASE, DIE #2<br/> 7. BASE, DIE #1<br/> 8. EMITTER, COMMON</p> | <p><b>STYLE 10:</b><br/> PIN 1. GROUND<br/> 2. BIAS 1<br/> 3. OUTPUT<br/> 4. GROUND<br/> 5. GROUND<br/> 6. BIAS 2<br/> 7. INPUT<br/> 8. GROUND</p>  | <p><b>STYLE 11:</b><br/> PIN 1. SOURCE 1<br/> 2. GATE 1<br/> 3. SOURCE 2<br/> 4. GATE 2<br/> 5. DRAIN 2<br/> 6. DRAIN 2<br/> 7. DRAIN 1<br/> 8. DRAIN 1</p>   | <p><b>STYLE 12:</b><br/> PIN 1. SOURCE<br/> 2. SOURCE<br/> 3. SOURCE<br/> 4. GATE<br/> 5. DRAIN<br/> 6. DRAIN<br/> 7. DRAIN<br/> 8. DRAIN</p>   |
| <p><b>STYLE 13:</b><br/> PIN 1. N.C.<br/> 2. SOURCE<br/> 3. SOURCE<br/> 4. GATE<br/> 5. DRAIN<br/> 6. DRAIN<br/> 7. DRAIN<br/> 8. DRAIN</p>  | <p><b>STYLE 14:</b><br/> PIN 1. N-SOURCE<br/> 2. N-GATE<br/> 3. P-SOURCE<br/> 4. P-GATE<br/> 5. P-DRAIN<br/> 6. P-DRAIN<br/> 7. N-DRAIN<br/> 8. N-DRAIN</p>   | <p><b>STYLE 15:</b><br/> PIN 1. ANODE 1<br/> 2. ANODE 1<br/> 3. ANODE 1<br/> 4. ANODE 1<br/> 5. CATHODE, COMMON<br/> 6. CATHODE, COMMON<br/> 7. CATHODE, COMMON<br/> 8. CATHODE, COMMON</p>               | <p><b>STYLE 16:</b><br/> PIN 1. EMITTER, DIE #1<br/> 2. BASE, DIE #1<br/> 3. EMITTER, DIE #2<br/> 4. BASE, DIE #2<br/> 5. COLLECTOR, DIE #2<br/> 6. COLLECTOR, DIE #2<br/> 7. COLLECTOR, DIE #1<br/> 8. COLLECTOR, DIE #1</p> |
| <p><b>STYLE 17:</b><br/> PIN 1. VCC<br/> 2. V2OUT<br/> 3. V1OUT<br/> 4. TXE<br/> 5. RXE<br/> 6. VEE<br/> 7. GND<br/> 8. ACC</p>  | <p><b>STYLE 18:</b><br/> PIN 1. ANODE<br/> 2. ANODE<br/> 3. SOURCE<br/> 4. GATE<br/> 5. DRAIN<br/> 6. DRAIN<br/> 7. CATHODE<br/> 8. CATHODE</p>   | <p><b>STYLE 19:</b><br/> PIN 1. SOURCE 1<br/> 2. GATE 1<br/> 3. SOURCE 2<br/> 4. GATE 2<br/> 5. DRAIN 2<br/> 6. MIRROR 2<br/> 7. DRAIN 1<br/> 8. MIRROR 1</p>   | <p><b>STYLE 20:</b><br/> PIN 1. SOURCE (N)<br/> 2. GATE (N)<br/> 3. SOURCE (P)<br/> 4. GATE (P)<br/> 5. DRAIN<br/> 6. DRAIN<br/> 7. DRAIN<br/> 8. DRAIN</p>   |
| <p><b>STYLE 21:</b><br/> PIN 1. CATHODE 1<br/> 2. CATHODE 2<br/> 3. CATHODE 3<br/> 4. CATHODE 4<br/> 5. CATHODE 5<br/> 6. COMMON ANODE<br/> 7. COMMON ANODE<br/> 8. CATHODE 6</p>  | <p><b>STYLE 22:</b><br/> PIN 1. I/O LINE 1<br/> 2. COMMON CATHODE/VCC<br/> 3. COMMON CATHODE/VCC<br/> 4. I/O LINE 3<br/> 5. COMMON ANODE/GND<br/> 6. I/O LINE 4<br/> 7. I/O LINE 5<br/> 8. COMMON ANODE/GND</p> | <p><b>STYLE 23:</b><br/> PIN 1. LINE 1 IN<br/> 2. COMMON ANODE/GND<br/> 3. COMMON ANODE/GND<br/> 4. LINE 2 IN<br/> 5. LINE 2 OUT<br/> 6. COMMON ANODE/GND<br/> 7. COMMON ANODE/GND<br/> 8. LINE 1 OUT</p> | <p><b>STYLE 24:</b><br/> PIN 1. BASE<br/> 2. EMITTER<br/> 3. COLLECTOR/ANODE<br/> 4. COLLECTOR/ANODE<br/> 5. CATHODE<br/> 6. CATHODE<br/> 7. COLLECTOR/ANODE<br/> 8. COLLECTOR/ANODE</p>                                      |
| <p><b>STYLE 25:</b><br/> PIN 1. VIN<br/> 2. N/C<br/> 3. REXT<br/> 4. GND<br/> 5. IOUT<br/> 6. IOUT<br/> 7. IOUT<br/> 8. IOUT</p>   | <p><b>STYLE 26:</b><br/> PIN 1. GND<br/> 2. dv/dt<br/> 3. ENABLE<br/> 4. ILIMIT<br/> 5. SOURCE<br/> 6. SOURCE<br/> 7. SOURCE<br/> 8. VCC</p>  | <p><b>STYLE 27:</b><br/> PIN 1. ILIMIT<br/> 2. OVLO<br/> 3. UVLO<br/> 4. INPUT+<br/> 5. SOURCE<br/> 6. SOURCE<br/> 7. SOURCE<br/> 8. DRAIN</p>  | <p><b>STYLE 28:</b><br/> PIN 1. SW_TO_GND<br/> 2. DASIC OFF<br/> 3. DASIC_SW_DET<br/> 4. GND<br/> 5. V_MON<br/> 6. VBULK<br/> 7. VBULK<br/> 8. VIN</p>  |
| <p><b>STYLE 29:</b><br/> PIN 1. BASE, DIE #1<br/> 2. EMITTER, #1<br/> 3. BASE, #2<br/> 4. EMITTER, #2<br/> 5. COLLECTOR, #2<br/> 6. COLLECTOR, #2<br/> 7. COLLECTOR, #1<br/> 8. COLLECTOR, #1</p>                        | <p><b>STYLE 30:</b><br/> PIN 1. DRAIN 1<br/> 2. DRAIN 1<br/> 3. GATE 2<br/> 4. SOURCE 2<br/> 5. SOURCE 1/DRAIN 2<br/> 6. SOURCE 1/DRAIN 2<br/> 7. SOURCE 1/DRAIN 2<br/> 8. GATE 1</p>                           |   |   |

<b>DOCUMENT NUMBER:</b>	<b>98ASB42564B</b>	Electronic versions are uncontrolled except when accessed directly from the Document Repository. Printed versions are uncontrolled except when stamped "CONTROLLED COPY" in red.
<b>DESCRIPTION:</b>	<b>SOIC-8 NB</b>	<b>PAGE 2 OF 2</b>

ON Semiconductor and  are trademarks of Semiconductor Components Industries, LLC dba ON Semiconductor or its subsidiaries in the United States and/or other countries. ON Semiconductor reserves the right to make changes without further notice to any products herein. ON Semiconductor makes no warranty, representation or guarantee regarding the suitability of its products for any particular purpose, nor does ON Semiconductor assume any liability arising out of the application or use of any product or circuit, and specifically disclaims any and all liability, including without limitation special, consequential or incidental damages. ON Semiconductor does not convey any license under its patent rights nor the rights of others.

ON Semiconductor and  are trademarks of Semiconductor Components Industries, LLC dba ON Semiconductor or its subsidiaries in the United States and/or other countries. ON Semiconductor owns the rights to a number of patents, trademarks, copyrights, trade secrets, and other intellectual property. A listing of ON Semiconductor's product/patent coverage may be accessed at [www.onsemi.com/site/pdf/Patent-Marking.pdf](http://www.onsemi.com/site/pdf/Patent-Marking.pdf). ON Semiconductor reserves the right to make changes without further notice to any products herein. ON Semiconductor makes no warranty, representation or guarantee regarding the suitability of its products for any particular purpose, nor does ON Semiconductor assume any liability arising out of the application or use of any product or circuit, and specifically disclaims any and all liability, including without limitation special, consequential or incidental damages. Buyer is responsible for its products and applications using ON Semiconductor products, including compliance with all laws, regulations and safety requirements or standards, regardless of any support or applications information provided by ON Semiconductor. "Typical" parameters which may be provided in ON Semiconductor data sheets and/or specifications can and do vary in different applications and actual performance may vary over time. All operating parameters, including "Typicals" must be validated for each customer application by customer's technical experts. ON Semiconductor does not convey any license under its patent rights nor the rights of others. ON Semiconductor products are not designed, intended, or authorized for use as a critical component in life support systems or any FDA Class 3 medical devices or medical devices with a same or similar classification in a foreign jurisdiction or any devices intended for implantation in the human body. Should Buyer purchase or use ON Semiconductor products for any such unintended or unauthorized application, Buyer shall indemnify and hold ON Semiconductor and its officers, employees, subsidiaries, affiliates, and distributors harmless against all claims, costs, damages, and expenses, and reasonable attorney fees arising out of, directly or indirectly, any claim of personal injury or death associated with such unintended or unauthorized use, even if such claim alleges that ON Semiconductor was negligent regarding the design or manufacture of the part. ON Semiconductor is an Equal Opportunity/Affirmative Action Employer. This literature is subject to all applicable copyright laws and is not for resale in any manner.

## PUBLICATION ORDERING INFORMATION

### LITERATURE FULFILLMENT:

Email Requests to: [orderlit@onsemi.com](mailto:orderlit@onsemi.com)

ON Semiconductor Website: [www.onsemi.com](http://www.onsemi.com)

### TECHNICAL SUPPORT

North American Technical Support:  
Voice Mail: 1 800-282-9855 Toll Free USA/Canada  
Phone: 011 421 33 790 2910

Europe, Middle East and Africa Technical Support:

Phone: 00421 33 790 2910

For additional information, please contact your local Sales Representative