

# Read/write head

## IPH-18GM-V1

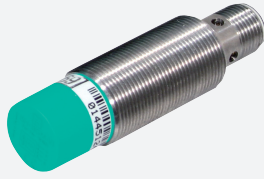

- Read/write head with thread M18 x 1
- Connection via V1 (M12 x 1) plug connection
- Multihole-LED for function display
- Degree of protection IP67
- For connection to IDENTControl control interface

LF read/write head for IDENTControl



### Dimensions

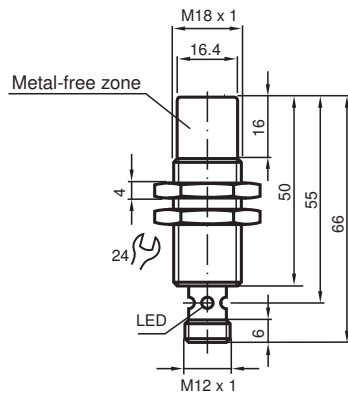

### Technical Data

General specifications	
Operating frequency	125 kHz
Transfer rate	2 kBit/s
Sensing range	
Read distance	1 ... 50 mm
Write distance	0 ... 40 mm
Width	max. 40 mm
Operating distance	maximum: 50 mm
UL File Number	E87056
Functional safety related parameters	
MTTF <sub>d</sub>	700 a
Mission Time (T <sub>M</sub> )	10 a
Diagnostic Coverage (DC)	0 %
Indicators/operating means	

Release date: 2020-05-11 Date of issue: 2020-05-11 Filename: 121115\_eng.pdf

Refer to "General Notes Relating to Pepperl+Fuchs Product Information".

Pepperl+Fuchs Group  
www.pepperl-fuchs.com

USA: +1 330 486 0001  
fa-info@us.pepperl-fuchs.com

Germany: +49 621 776 1111  
fa-info@de.pepperl-fuchs.com

Singapore: +65 6779 9091  
fa-info@sg.pepperl-fuchs.com

**PEPPERL+FUCHS**



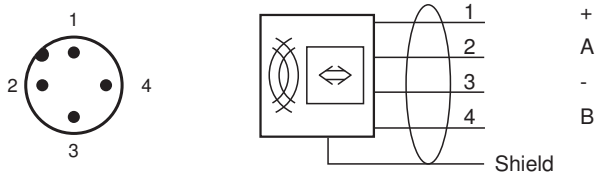

## Technical Data

LED green/yellow		Multihole-LED: green: power on green flashing: read/write attempt performed yellow: data carrier detected
<b>Electrical specifications</b>		
Power consumption	$P_0$	$\leq 1.2$ W
Supply		from the IDENTControl
<b>Directive conformity</b>		
Radio equipment		
Directive 2014/53/EU		EN 301489-1 EN 301489-3 EN 300330 EN 62368-1 EN 50364
RoHS		
Directive 2011/65/EU (RoHS)		EN 50581
<b>Standard conformity</b>		
Degree of protection		EN 60529
RFID		ISO/IEC 18000-2
<b>Ambient conditions</b>		
Ambient temperature		-25 ... 70 °C (-13 ... 158 °F)
Storage temperature		-40 ... 85 °C (-40 ... 185 °F)
<b>Mechanical specifications</b>		
Degree of protection		IP67
Connection		connector M12 x 1
Material		
Housing		PBT/stainless steel
Encapsulation compound		Fermadur
Installation		
Distance between two heads		Multiplex on: $\geq 30$ mm Multiplex off: $\geq 180$ mm
Mass		approx. 40 g













## Connection



## Accessories

	<b>IC-KP-B6-V15B</b>	Control interface unit IDENTControl with PROFIBUS DP interface
	<b>IC-KP-B17-AIDA1</b>	IDENTControl control interface with Ethernet interface for TCP/IP, PROFINET, EtherNet/IP, and MODBUS TCP protocols
	<b>IC-KP2-2HRX-2V1</b>	Control interface unit IDENTControl Compact with serial interface RS-232 and RS-485
	<b>IC-KP2-2HB6-V15B</b>	Control interface unit IDENTControl Compact with interface for PROFIBUS DP

## Accessories

	<b>IC-KP2-2HB17-2V1D</b>	IDENTControl Compact control interface with Ethernet interface for TCP/IP, PROFINET, EtherNet/IP, and MODBUS TCP protocols
	<b>IC-KP2-2HB21-2V1D</b>	Control interface unit IDENTControl Compact with EtherCAT interface
	<b>IPC02-26-T6 10pcs</b>	Code carrier
	<b>IPC03-C1 10pcs</b>	Data carrier
	<b>IPC03-12.4 10pcs</b>	Data carrier
	<b>IPC03-30P</b>	Data carrier
	<b>IPC03-58</b>	Data carrier
	<b>V1-G-2M-PUR-ABG-V1-W</b>	Connecting cable, M12 to M12, PUR cable 4-pin, shielded
	<b>V1-G-5M-PUR-ABG-V1-W</b>	Connecting cable, M12 to M12, PUR cable 4-pin, shielded
	<b>V1-G-10M-PUR-ABG-V1-W</b>	Connecting cable, M12 to M12, PUR cable 4-pin, shielded
	<b>IPC03-50P</b>	Data carrier
	<b>IPC02-50P</b>	Code carrier
	<b>IPC02-12 50pcs</b>	Code carrier