

Fuse plug - PV-C-M/F-PRO/F-1500/25-EU-SPR - 1623412

Please be informed that the data shown in this PDF Document is generated from our Online Catalog. Please find the complete data in the user's documentation. Our General Terms of Use for Downloads are valid (<http://phoenixcontact.com/download>)



Fuse connector for protecting modules and devices in photovoltaic systems, black, SUNCLIX pin connector pattern, 1500 V/25 A, IP68 (24 h/2 m)

SUNCLIX fuse connector, in the version for 1500 V system voltage

Product Description

SUNCLIX fuse connector for 1500 V system voltage, fuse-link nominal current of 25 A, EU version, version with spacer for better heat dissipation when bundling

Your advantages

- One-piece design
- Robust, easy-to-install fuse element for outdoor use
- High-quality fuse-link
- Degree of protection: IP68 (24 h/2 m)
-
- 1500 V



Key Commercial Data

Packing unit	8 pc
Minimum order quantity	8 pc
GTIN	 4 055626 142203
GTIN	4055626142203

Technical data

Ambient conditions

Degree of protection (when plugged in)	IP66 / IP68 (2 m / 24 h)
Ambient temperature (operation)	-40 °C ... 50 °C

General

Degree of protection	IP66 / IP68 (2 m / 24 h)
Rated voltage	1500 V

Fuse plug - PV-C-M/F-PRO/F-1500/25-EU-SPR - 1623412

Technical data

General

Fuse-link nominal current	25 A DC (Nominal current of the fuse-link)
Fuse adapter nominal current	23 A DC

Material

Flammability rating according to UL 94	V0
----------------------------------------	----

Standards and Regulations

Flammability rating according to UL 94	V0
----------------------------------------	----

Environmental Product Compliance

China RoHS	Environmentally friendly use period: unlimited = EFUP-e
	No hazardous substances above threshold values

Drawings

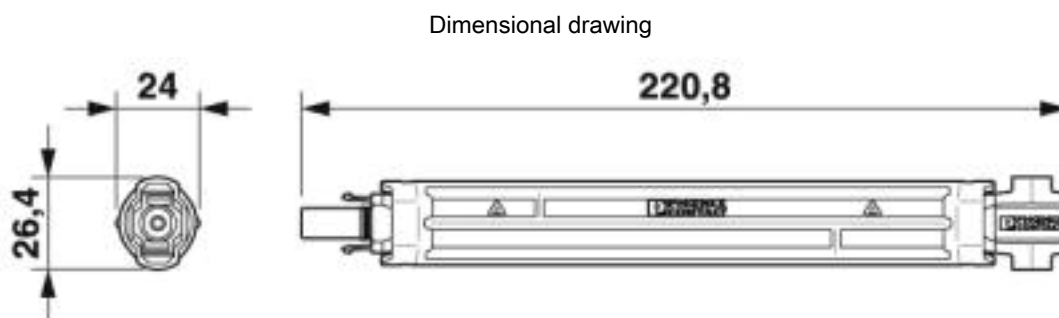

Classifications

eCl@ss

eCl@ss 4.0	27260700
eCl@ss 4.1	27260700
eCl@ss 5.0	27260700
eCl@ss 5.1	27260700
eCl@ss 6.0	27260700
eCl@ss 7.0	27440102
eCl@ss 8.0	27440102
eCl@ss 9.0	27440107

ETIM

ETIM 5.0	EC002635
ETIM 6.0	EC002635
ETIM 7.0	EC002635

UNSPSC

UNSPSC 13.2	39121409
-------------	----------

Fuse plug - PV-C-M/F-PRO/F-1500/25-EU-SPR - 1623412

Classifications

UNSPSC

UNSPSC 19.0	39121409
-------------	----------

Phoenix Contact 2020 © - all rights reserved
<http://www.phoenixcontact.com>

PHOENIX CONTACT GmbH & Co. KG
Flachsmarktstr. 8
32825 Blomberg
Germany
Tel. +49 5235 300
Fax +49 5235 3 41200
<http://www.phoenixcontact.com>