

# PE4271

### Product Description

The PE4271 is a high-isolation Switch designed for CATV applications, covering a broad frequency range from near DC up to 3000 MHz. This single-supply SPST switch offers a single-pin CMOS control interface with industry leading CTB performance. It also provides low insertion loss, high isolation and extremely low bias requirements while operating on a single 3-volt supply. In a typical CATV application, the PE4271 provides for a cost effective and manufacturable solution vs. mechanical relays.

The PE4271 is manufactured on Peregrine's UltraCMOS™ process, a patented variation of silicon-on-insulator (SOI) technology on a sapphire substrate, offering the performance of GaAs with the economy and integration of conventional CMOS.

**Figure 1. Functional Diagram**

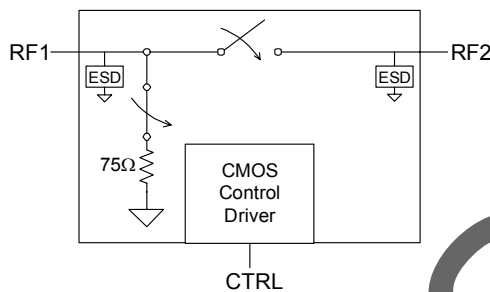

**SPST CATV UltraCMOS™ Switch  
DC - 3000 MHz**

### Features

- Integrated 0.25 watt terminations
- CTB performance of 90 dBc
- High isolation: 85 dB at 5 MHz, 60 dB at 1000 MHz
- Low insertion loss: 0.5 dB at 5 MHz, 0.70 dB at 1000 MHz
- High input IP2: >80 dBm
- CMOS/TTL single-pin control
- Single +3-volt supply operation
- Extremely low bias: 8  $\mu$ A @ 3 V
- Available in a 6-lead DFN package

**Figure 2. Package Type**

6-lead DFN



**Table 1. Electrical Specifications @ +25 °C ( $Z_S = Z_L = 75 \Omega$ )**

Parameter	Condition	Minimum	Typical	Maximum	Units
Operating Frequency <sup>1</sup>		DC		3000	MHz
Insertion Loss	DC - 50 MHz 1000 MHz		0.50 0.70	0.65 0.85	dB
Isolation	DC - 50 MHz 1000 MHz	80 58	85 60		dB
Return Loss	DC - 1000 MHz $V_{CTRL} = 3.0V$	15	16		dB
Input 1 dB Compression <sup>2,4</sup>	1000 MHz	30	33		dBm
CTB / CSO	77 & 110 channels; PO = 44 dBmV		-90		dBc
Input IP2 <sup>2</sup>	1000 MHz	80			dBm
Input IP3 <sup>2</sup>	1000 MHz	50			dBm
Video Feedthrough <sup>3</sup>				15	mV <sub>pp</sub>
Switching Time			2		$\mu$ S

- Notes: 1. Device linearity will begin to degrade below 1 MHz.  
 2. Measured in a 50  $\Omega$  system.  
 3. Measured with a 1 ns risetime, 0/3 V pulse and 500 MHz bandwidth.  
 4. Note Absolute Maximum ratings in Table 3.

Figure 3. Pin Configuration

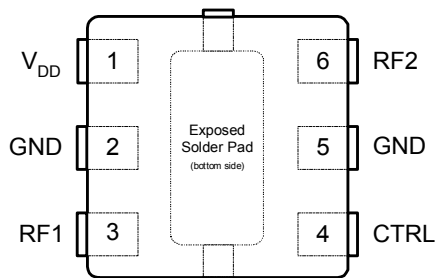

Table 2. Pin Descriptions

Pin No.	Pin Name	Description
1	V <sub>DD</sub>	Nominal 3V supply connection.
2	GND	Ground connection. <sup>2</sup>
3	RF1	RF port. <sup>1</sup>
4	CTRL	CMOS or TTL logic level: High = RF1 to RF2 signal path Low = RF1 isolated from RF2
5	GND	Ground connection. <sup>3</sup>
6	RF2	RF port. <sup>1</sup>

Notes: 1. Both RF pins must be held at 0 V<sub>DC</sub> or require external DC blocking capacitors  
2. The exposed pad must be soldered to the ground plane for proper switch performance.

Table 3. Absolute Maximum Ratings

Symbol	Parameter/Condition	Min	Max	Unit
V <sub>DD</sub>	Power supply voltage	-0.3	4.0	V
V <sub>I</sub>	Voltage on CTRL input	-0.3	5.5	V
T <sub>ST</sub>	Storage temperature	-65	150	°C
P <sub>IN</sub>	Input power (50Ω), CTRL=1/CTRL=0		33/24	dBm
V <sub>ESD</sub>	ESD voltage (Human Body Model)		500	V

Exceeding absolute maximum ratings may cause permanent damage. Operation should be restricted to the limits in the Operating Ranges table. Operation between operating range maximum and absolute maximum for extended periods may reduce reliability.

### Latch-Up Avoidance

Unlike conventional CMOS devices, UltraCMOS™ devices are immune to latch-up.

### Moisture Sensitivity Level

The Moisture Sensitivity Level rating for the PE4271 in the 6-lead 3x3 DFN package is MSL1.

Table 4. Operating Ranges

Parameter	Min	Typ	Max	Unit
V <sub>DD</sub> Power Supply	2.7	3.0	3.3	V
I <sub>DD</sub> Power Supply Current (V <sub>DD</sub> = 3V, V <sub>CTRL</sub> = 3V)		8	20	μA
T <sub>OP</sub> Operating temperature	-40		85	°C
Control Voltage High	0.7xV <sub>DD</sub>		5	V
Control Voltage Low	0		0.3xV <sub>DD</sub>	V

Figure 4. Typical Application Block Diagram

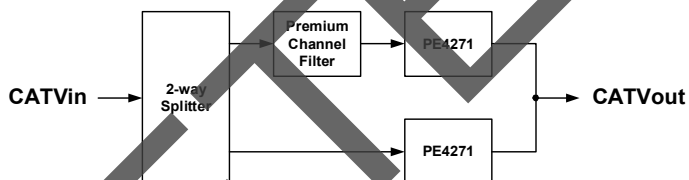

Table 5. Control Logic Truth Table

Control Voltage (CTRL)	Signal Path (RF1 to RF2)
High <sup>1</sup>	ON
Low	OFF

Notes: 1. CTRL accepts both CMOS and TTL voltage levels.

### Electrostatic Discharge (ESD) Precautions

When handling this UltraCMOS™ device, observe the same precautions that you would use with other ESD-sensitive devices. Although this device contains circuitry to protect it from damage due to ESD, precautions should be taken to avoid exceeding the rating specified in Table 3.

### Device Description

The PE4271 high isolation SPST CATV Switch is designed to support CATV applications such as premium channel service connect/disconnect switch blocks. This function is typically performed by bulky and expensive mechanical switches. The high isolation characteristics (60 dB at 1 GHz, 85 dB at 5 MHz), high compression point, and an integrated 75 Ω (0.25 watt) input termination make the PE4271 an ideal, low cost solution.

The control logic input pin (CTRL) is typically driven by a 3-volt CMOS logic level signal, and has a threshold of 50% of V<sub>DD</sub>. For flexibility to support systems that have 5-volt control logic drivers, the control logic input has been designed to handle a 5-volt logic HIGH signal. (A minimal current will be sourced out of the V<sub>DD</sub> pin when the control logic input voltage level exceeds V<sub>DD</sub>.)

Typical Performance Data @ -40 °C to 85 °C (Unless Otherwise Noted)  
(75 Ω impedance except as indicated)

Figure 5. Insertion Loss - RF1 to RF2

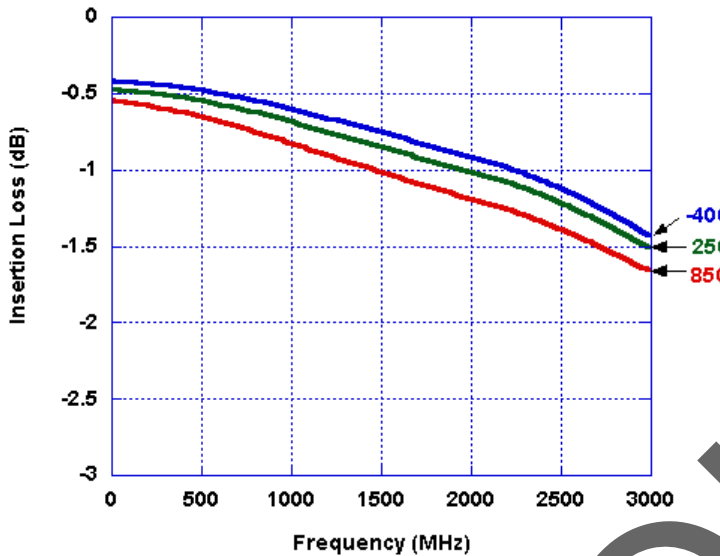

Figure 6. 1dB Compression & 3<sup>rd</sup> Order Intercept Point (T = 25°C)

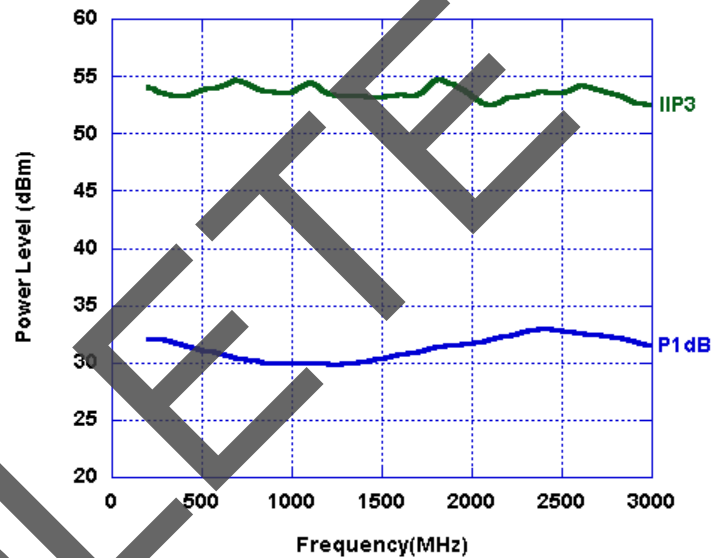
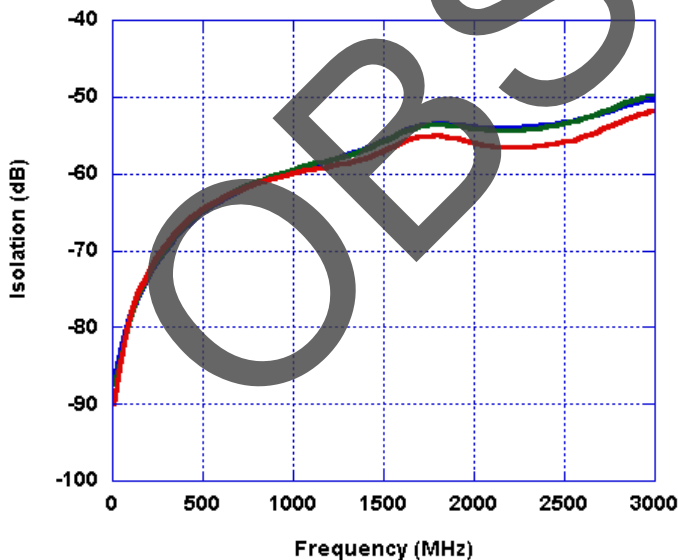
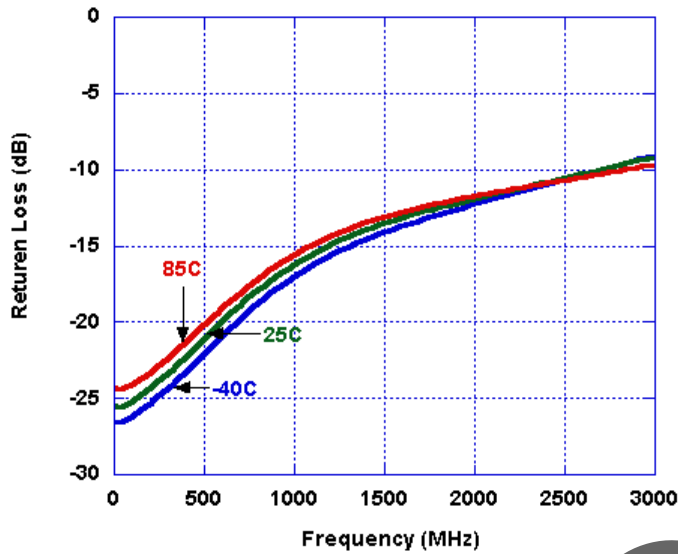

Figure 7. Isolation - RF1 to RF2



**Typical Performance Data @ -40 °C to 85 °C (Unless Otherwise Noted)**  
(75-ohm impedance)

**Figure 8. RF1 Return Loss (Switch = ON)**



**Figure 9. RF1 Return Loss (Switch = OFF)**

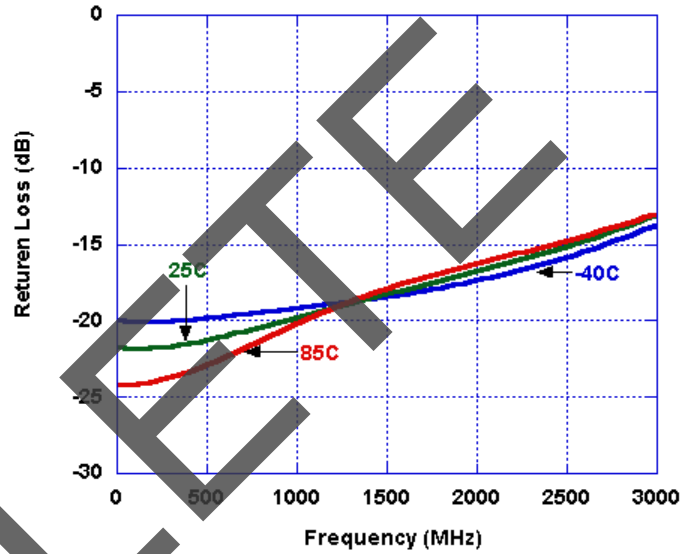

**Figure 10. RF2 Return Loss (Switch = ON)**

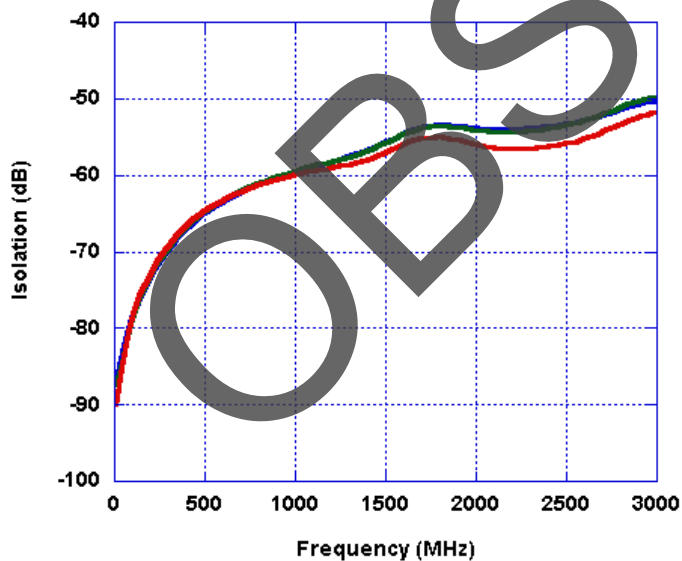

### Evaluation Kit

The PE4271 EK board was designed to ease customer evaluation of Peregrine’s high performance SPST CATV MOSFET switch. RF1 is connected through a 75 Ω transmission line via the top left F connector, J1. RF2 is connected through a 75 Ω transmission line via the top right F connector, J2. A 75 Ω through transmission line is available via F connectors J3 and J4. This transmission line can be used to estimate the loss of the PCB over the environmental conditions being evaluated. V<sub>DD</sub> is supplied via J6-2, while the control logic voltage is supplied via J5-2. It is the responsibility of the customer to determine proper supply decoupling for their design application. It has been observed that by removing C1 and C2 from the evaluation board has not shown to degrade RF performance.

The board is constructed of a two metal layer FR4 material with a total thickness of 0.031”. The bottom layer provides ground for the RF transmission lines. The transmission lines were designed using a coplanar waveguide model with trace width of 0.021”, trace gaps of 0.030”, dielectric thickness of 0.028”, metal thickness of 0.0021” and ε<sub>r</sub> of 4.6. Note that the predominate mode for these transmission lines is coplanar waveguide with a ground plane.

**Figure 11. Evaluation Board Layouts**

Peregrine Specification 101/0167 (with F connectors)

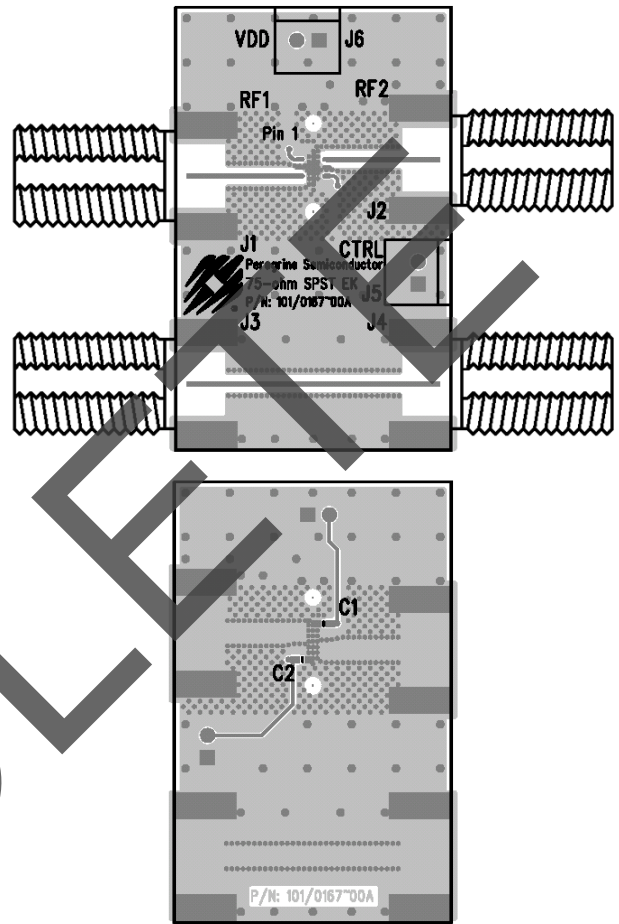

**Figure 12. Evaluation Board Schematic**

Peregrine Specification 102/0245

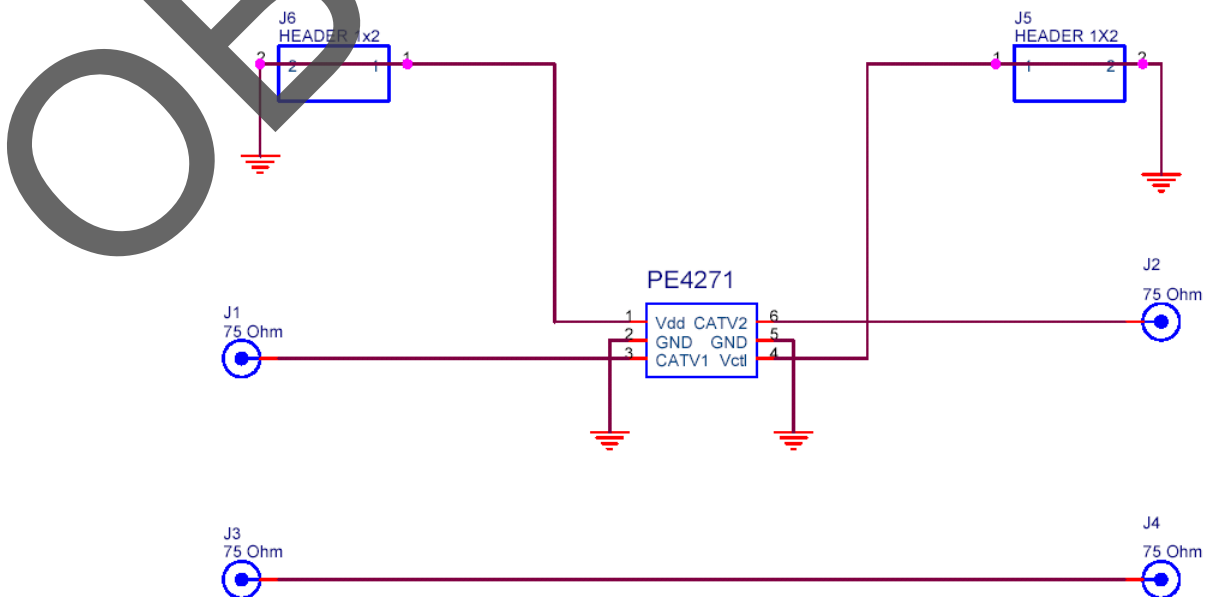

**Figure 13. Package Drawing**

6-lead DFN

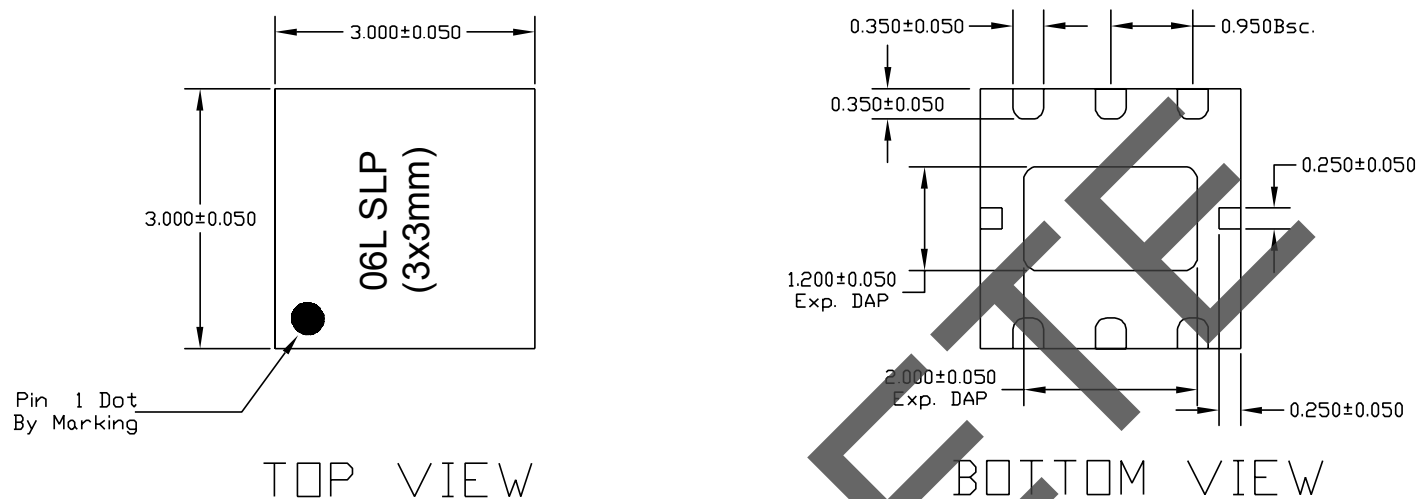

**NOTE:**

1) TSLP AND SLP SHARE THE SAME EXPOSE OUTLINE BUT WITH DIFFERENT THICKNESS:

A	TSLP		SLP	
	MAX.	0.800	0.900	
NOM.	0.750	0.850		
MIN.	0.700	0.800		

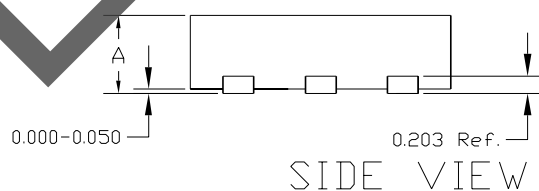

NOTE: The exposed solder pad (on the bottom of the package) is not electrically connected to any other pin (isolated).

**Figure 14. Marking Specifications**

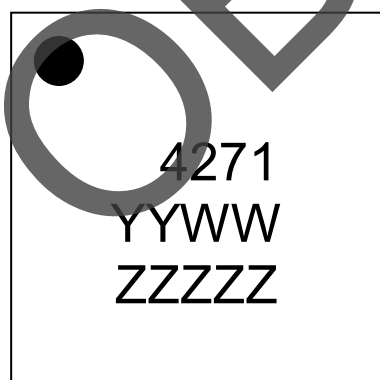

YYWW = Date Code (last two digits of year and work week)  
ZZZZZ = Last five digits of Lot Number

**Figure 15. Tape and Reel Specifications**

6-lead DFN

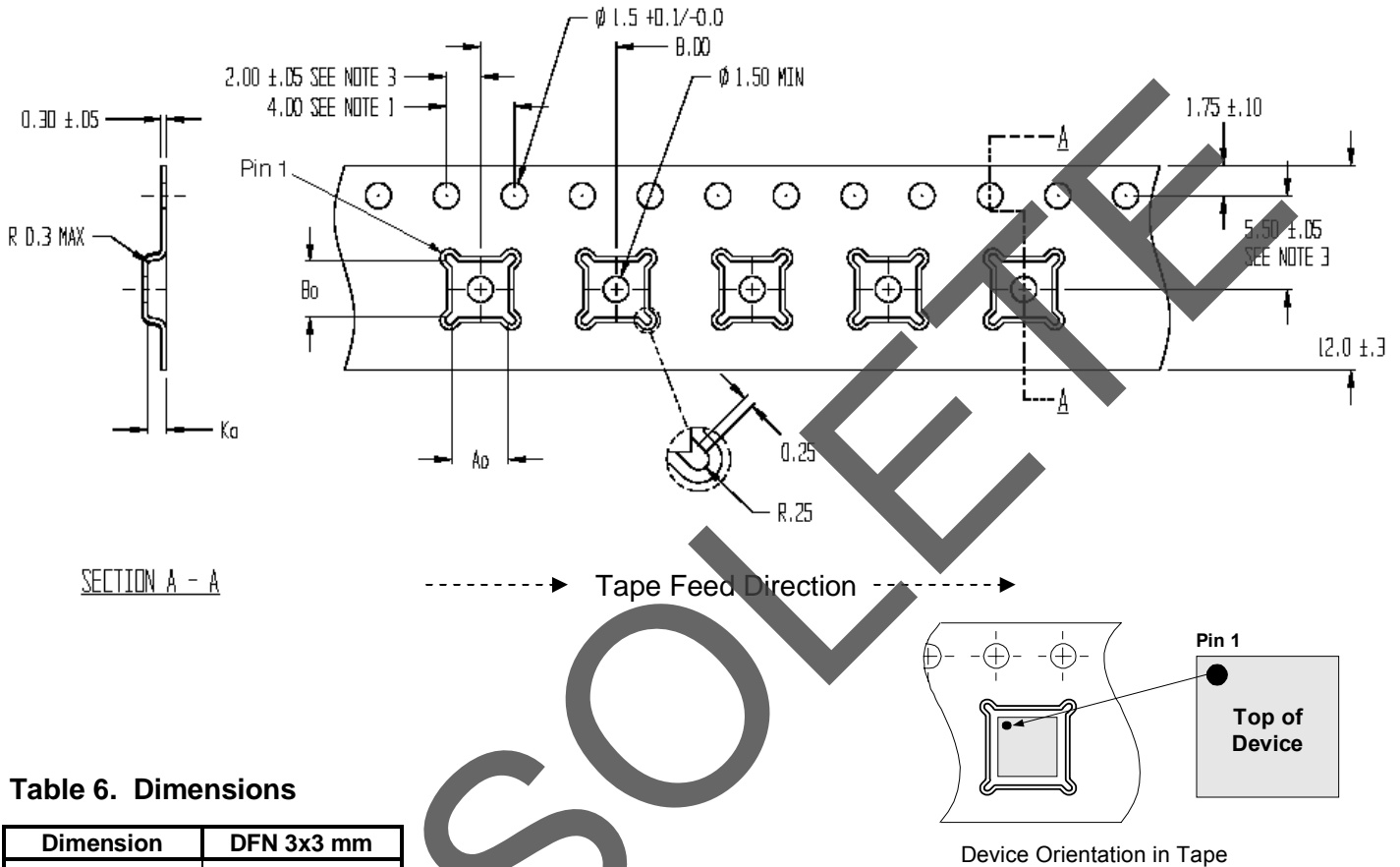

**Table 6. Dimensions**

Dimension	DFN 3x3 mm
Ao	3.23 ± 0.1
Bo	3.17 ± 0.1
Ko	1.37 ± 0.1
P	4 ± 0.1
W	8 +0.3, -0.1
T	0.254 ± 0.02
R7 Quantity	3000
R13 Quantity	N.A.

Note: R7 = 7 inch Lock Reel, R13 = 13 inch Lock Reel

NOTES:

1. 10 SPROCKET HOLE PITCH CUMULATIVE TOLERANCE ±0.2
2. CAMBER IN COMPLIANCE WITH EIA 481
3. POCKET POSITION RELATIVE TO SPROCKET HOLE MEASURED AS TRUE POSITION OF POCKET, NOT POCKET HOLE

**Table 7. Ordering Information**

Order Code	Part Marking	Description	Package	Shipping Method
4271-51	4271	PE4271G-06DFN 3x3mm-12800F	Green 6-lead 3x3 mm DFN	Tape or loose
4271-52	4271	PE4271G-06DFN 3x3mm-3000C	Green 6-lead 3x3 mm DFN	3000 units / T&R
4271-00	PE4271-EK	PE4271-06DFN 3x3mm-EK	Evaluation Kit	1 / Box

## Sales Offices

### *The Americas*

#### **Peregrine Semiconductor Corporation**

9380 Carroll Park Drive  
San Diego, CA 92121  
Tel: 858-731-9400  
Fax: 858-731-9499

### *Europe*

#### **Peregrine Semiconductor Europe**

Bâtiment Maine  
13-15 rue des Quatre Vents  
F-92380 Garches, France  
Tel: +33-1-4741-9173  
Fax : +33-1-4741-9173

### **High-Reliability and Defense Products**

#### *Americas*

San Diego, CA, USA  
Phone: 858-731-9475  
Fax: 848-731-9499

#### *Europe/Asia-Pacific*

Aix-En-Provence Cedex 3, France  
Phone: +33-4-4239-3361  
Fax: +33-4-4239-7227

For a list of representatives in your area, please refer to our Web site at: [www.psemi.com](http://www.psemi.com)

## Data Sheet Identification

### **Advance Information**

The product is in a formative or design stage. The data sheet contains design target specifications for product development. Specifications and features may change in any manner without notice.

### **Preliminary Specification**

The data sheet contains preliminary data. Additional data may be added at a later date. Peregrine reserves the right to change specifications at any time without notice in order to supply the best possible product.

### **Product Specification**

The data sheet contains final data. In the event Peregrine decides to change the specifications, Peregrine will notify customers of the intended changes by issuing a DCN (Document Change Notice).

### **Peregrine Semiconductor, Asia Pacific (APAC)**

Shanghai, 200040, P.R. China  
Tel: +86-21-5836-8276  
Fax: +86-21-5836-7652

### **Peregrine Semiconductor, Korea**

#B-2607, Kolon Tripolis, 210  
Geumgok-dong, Bundang-gu, Seongnam-si  
Gyeonggi-do, 463-943 South Korea  
Tel: +82-31-728-3939  
Fax: +82-31-728-3940

### **Peregrine Semiconductor K.K., Japan**

Teikoku Hotel Tower 10B-6  
1-1-1 Uchisaiwai-cho, Chiyoda-ku  
Tokyo 100-0011 Japan  
Tel: +81-3-3502-5211  
Fax: +81-3-3502-5213

The information in this data sheet is believed to be reliable. However, Peregrine assumes no liability for the use of this information. Use shall be entirely at the user's own risk.

No patent rights or licenses to any circuits described in this data sheet are implied or granted to any third party.

Peregrine's products are not designed or intended for use in devices or systems intended for surgical implant, or in other applications intended to support or sustain life, or in any application in which the failure of the Peregrine product could create a situation in which personal injury or death might occur. Peregrine assumes no liability for damages, including consequential or incidental damages, arising out of the use of its products in such applications.

The Peregrine name, logo, and UTSi are registered trademarks and UltraCMOS, HaRP, MultiSwitch and DuNE are trademarks of Peregrine Semiconductor Corp.