

### FEATURES

- Dedicated Single Chip Solution for Mobile Power With Minimal Component Count
- 2.4A Continuous Output Current in Boost Mode
- 2.4A Switching Charger Current
- 96% Boost Efficiency ( $V_{bat}=4.1V$ )
- Adaptive to 10mA-2400mA Input Sources
- Battery Disconnection at Output Short
- $<10\mu A$  Low Battery Leakage Current at HZ Mode During Storage
- Boost Auto Turn-off at No Load and Push Button Turn-on
- Battery Over Current, Over Voltage, Over Temperature and Short Circuit Protections
- Boost Auto Startup with Load Detection
- Prioritized Power Path from Input to Output
- 5V $\pm$ 100mV Output Voltage in Boost Mode
- 1.1MHz/0.55MHz Switching Frequencies
- 2.2uH Inductor and Low Profile Ceramic Capacitor
- 4 LEDs Battery Level and Status Indication
- Battery Impedance Compensation
- Full Cycle of Battery Charge Management Preconditioning, Fast Charge, Top off and End of Charge
- Charge Current Foldback at 110°C Die Temperature
- IC Over Temperature Protection at 160°C
- FCQFN 4x4-20 Package

### APPLICATIONS

- Power Bank
- Mobile Power
- Backup Battery Pack
- Standalone Battery Charger with USB Output

### GENERAL DESCRIPTION

ACT2813 is a space-saving and high-performance low-profile single-chip solution for backup battery pack and standalone battery charger. ACT2813 integrates all the functions that a backup battery pack needs, including switching charger, boost converter and LED indication.

ACT2813 operates at 1.1MHz for switching charger and 0.55MHz for boost converter allowing tiny external inductor and capacitors. ACT2813 provides a direct power path from input to output while providing power to switching charger. Output has higher priority than battery charger if the input current limit is reached.

ACT2813 charges battery with full cycle of preconditioning, fast charge with constant current and constant voltage until end of charge. The battery charger is thermally regulated at 110°C with charge current foldback.

ACT2813 boost converter steps battery voltage up to 5V. Boost converter features high efficiency, constant current regulation, short circuit protection and over voltage protection.

ACT2813 provides 3.5mA constant currents to drive 4 LEDs to indicate battery level and charge status. Battery impedance is compensated for battery level indication.

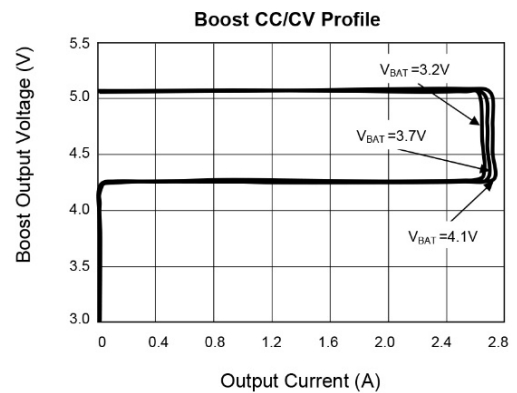
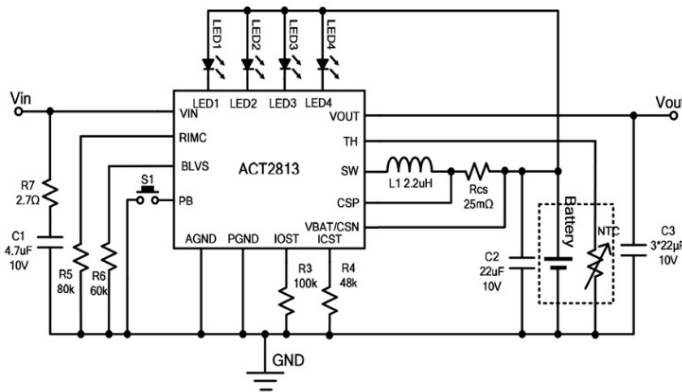

**ORDERING INFORMATION**

PART NUMBER	OUTPUT	CHARGE CURRENT	BATTERY VOLTAGE	FLASHLIGHT	TH PIN	PACKAGE
ACT2813QY-T	5V/2.4A	2.4A	4.2V	No	Yes	FCQFN 4x4-20
ACT2813QY-T0435	5V/2.4A	2.4A	4.35V	No	Yes	FCQFN 4x4-20

**PIN CONFIGURATION**

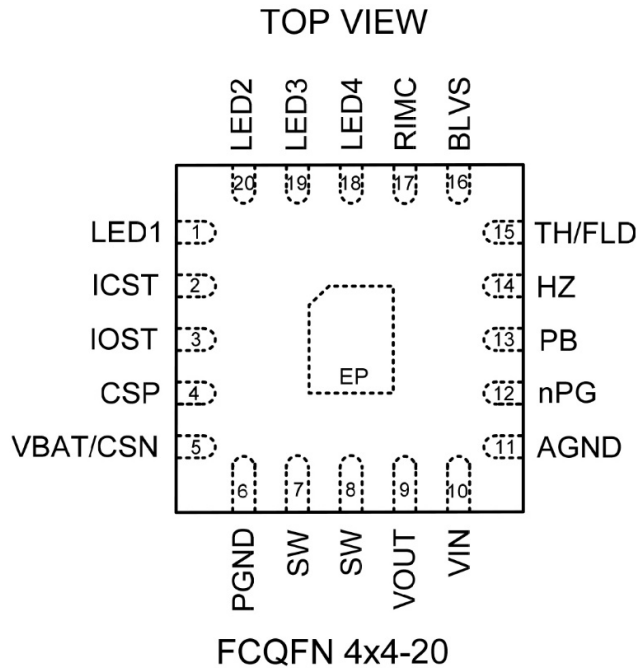

## PIN DESCRIPTIONS

PIN NUMBER	NAME	DESCRIPTION
1	LED1	Battery level indicator. An internal 3.5mA sink current limit is built in.
2	ICST	Fast charge current setting pin. Connect a resistor from this pin to AGND to set the charge current. The current setting ranges from 1.0A-3.0A.
3	IOST	Output current setting. Connect a resistor from this pin to AGND to set output constant current. The current setting ranges from 1.0A-3.0A.
4	CSP	Positive terminal of charge current sense input. Kevin sense is required with 10nF ceramic capacitor right across CSP and CSN pins.
5	VBAT/CSN	Battery input and negative terminal of charge current sense input. Connected to the battery pack positive terminal to provide power in High-Z mode. Bypass to PGND with a high quality ceramic capacitor placed as close to the IC as possible.
6	PGND	Power ground. PGND is connected to the source of low-side N-channel MOSFET and the MOSFET's gate driver. PGND must be connected to AGND externally through ground plane.
7, 8	SW	Internal switch to output inductor terminal.
9	VOUT	Output pin. Bypass to PGND with a high quality low ESR and ESL ceramic capacitor placed as close to the IC as possible.
10	VIN	USB or AC adaptor input. When VIN is valid, charge and power path is enabled.
11	AGND	Analog ground. AGND must be connected to PGND externally through ground plane.
12	nPG	Drive external P-FET to protect output short circuit and leakage during shutdown. nPG pin is pulled up to VOUT internally. nPG pin is pulled low if VOUT is in the range.
13	PB	Push button input, connect a push button from this pin to AGND, internally pulled up by a 3MΩ resistor to battery. PB starts up boost converter if HZ pin is grounded and VIN is not present. When this pin is pushed for 30ms, LED1-4 indicators are enable for 5 seconds.
14	HZ	Boost/high-Z mode enable pin, internally pulled up by a 3MΩ resistor to battery. When HZ pin is pulled ground, boost is enabled if VIN is not present.
15	TH	Temperature sensing input. Connect to battery thermistor terminal. If no use, put 10K pulled down resistor.
16	BLVS	Battery level voltage shift. Connect a resistor from this pin to AGND to shift the battery LED indication thresholds.
17	RIMC	Battery impedance compensation input. Connect to a resistor from this pin to APNG to program the battery impedance.
18	LED4	Battery level indicator. An internal 3.5mA sink current limit is built in.
19	LED3	Battery level indicator. An internal 3.5mA sink current limit is built in.
20	LED2	Battery level indicator. An internal 3.5mA sink current limit is built in.
21	EP	Exposed pad. Must be soldered to ground on the PCB.

## ABSOLUTE MAXIMUM RATINGS<sup>①</sup>

PARAMETER	VALUE	UNIT
All the Pin to PGND and AGND	-0.3 to 6.5	V
Junction to Ambient Thermal Resistance	40	°C/W
Maximum Power Dissipation	2.5	W
Operating Ambient Temperature	-40 to 85	°C
Operating Junction Range	-40 to 150	°C
Storage Junction Temperature	-40 to 150	°C
Lead Temperature (Soldering, 10 sec)	300	°C

①: Do not exceed these limits to prevent damage to the device. Exposure to absolute maximum rating conditions for long periods may affect device reliability.

## ELECTRICAL CHARACTERISTICS

( $V_{IN} = 5V$ ,  $T_A = 25^\circ C$ , unless otherwise specified.)

PARAMETER	TEST CONDITIONS	MIN	TYP	MAX	UNIT
<b>Input Current Limit</b>					
Input Voltage Range		4.5		5.5	V
$V_{IN}$ Over Voltage Protection	$V_{IN}$ rising, $V_{IN\_OVP}$	5.5	6.0	6.5	V
Input Voltage Validation Time	$V_{IN\_UVLO} < V_{IN} < V_{IN\_OVP}$		32		ms
Leakage Current from VOUT to VIN in Boost Mode	$3.0V < V_{BAT} < 4.2V$ , $T_A = 25^\circ C$		0	10	$\mu A$
Battery Discharge Current in High-Z Mode	$3.0V < V_{BAT} < 4.2V$ , $T_A = 25^\circ C$		7.5	15	$\mu A$
<b>Power Switches</b>					
VIN-to-VOUT FET on Resistance			60		m $\Omega$
VOUT-to-SW FET on Resistance			45		m $\Omega$
SW-to-PGND FET on Resistance			45		m $\Omega$
<b>Buck Converter</b>					
Switching Frequency		-15%	1.1	+15%	MHz
High Side Switch Peak Current Limit		4.5	6		A
Minimum On-time			100		ns
Over Temperature Protection (OTP)	OTP rising		160		$^\circ C$
OTP Hysteresis	OTP falling		35		$^\circ C$
<b>Charge Mode</b>					
Charge Current Setting Range	$R_{CS} = 25m\Omega$ , $R_{ICST} = 20k\Omega - 60k\Omega$	1.0		3.0	A
Charge Current Setting ( $I_{CHRG}$ )	$R_{CS} = 25m\Omega$ , $R_{ICST} = 48k\Omega$	-10%	2.4	+10%	A
Thermal Regulation Temperature			110		$^\circ C$
End of Charge (EOC) Voltage	ACT2813	-0.5%	4.2	+0.5%	V
	ACT2813-T0435	-0.5%	4.35	+0.5%	V
Battery Over Voltage Threshold	V <sub>BAT</sub> rising		4.6		V
Battery Over Voltage Threshold Hysteresis	V <sub>BAT</sub> falling		200		mV
Fast Charge Current	V <sub>BAT</sub> = 3.5V		$I_{CHRG}$		A
Precondition Charge Current	$2.4V \leq V_{BAT} \leq 2.8V$ , Percent of $I_{CHRG}$		10		%
Precondition Voltage Threshold	V <sub>BAT</sub> rising		2.8		V
Precondition Voltage Threshold Hysteresis			130		mV
Low V <sub>BAT</sub> Charge Current	V <sub>BAT</sub> = 1V, $R_{ICST} = 48k\Omega$		200		mA
EOC Current Threshold	V <sub>BAT</sub> = 4.2V, percent of the fast charge current		15		%
Charge Restart Voltage Threshold			200		mV
TH Upper Temperature Voltage Threshold	Cold detect NTC thermistor, ACT2813		1.5		V
TH Lower Temperature Voltage Threshold	Hot detect NTC thermistor, ACT2813		0.3		V
TH Hysteresis	ACT2813		50		mV
TH Internal Pull-up Current	ACT2813		60		$\mu A$

## ELECTRICAL CHARACTERISTICS

( $V_{IN} = 5V$ ,  $T_A = 25^\circ C$ , unless otherwise specified.)

PARAMETER	TEST CONDITIONS	MIN	TYP	MAX	UNIT
<b>Charge Current Foldback</b>					
Charge Current Reduction Threshold1 of Vout1	Starting foldback point	4.59	4.7	4.81	V
Charge Current Reduction Threshold2 of Vout1	Stop foldback point, $R_{CS}=25m\Omega$ , $R_{ICST}=48k\Omega$		4.57		V
<b>Boost Mode</b>					
Input Voltage Operation Range		3.0		4.5	V
Switching Frequency		-15%	0.55	+15%	MHz
Input Voltage UVLO	VBAT rising		3.3		V
Input Voltage UVLO Hysteresis	VBAT falling		400		mV
Output Voltage (VOUT)	$T_a=25^\circ C$	4.97	5.05	5.10	V
Output Voltage Accuracy	All conditions	-3	VOUT	2	%
Output Voltage Transient Response	80mA-1A-80mA, 0.1A/us	4.75		5.25	V
	1A-2.4A-1A, 0.1A/us	4.7		5.25	V
Output Over Voltage Protection	VOUT rising		5.7		V
Output Over Voltage Protection Hysteresis	VOUT falling		300		mV
Output Current Regulation Range	$R_{CS}=25m\Omega$ , $R_{IOST}=37.4k\Omega - 113k\Omega$	1.0		3.0	A
Output Current	$R_{CS}=25m\Omega$ , $R_{IOST}=91k\Omega$	-10%	2.4	+10%	A
Maximum Voltage Across VRcs	All conditions		200		mV
Minimum On-Time			100		ns
Low Side Switch Peak Current Limit	VBAT=3.6V, VOUT=5V	5.6	6.8		A
Soft-Startup Time			400		$\mu s$
Under Voltage Protection (UVP Threshold)	VOUT falling		4.25		V
	VOUT rising		4.6		V
UVP Blanking Time During Startup			3		ms
UVP Sense Detection Time	VOUT falling		20		$\mu s$
Restart After UVP	Hiccup mode		2		s
Light Load Current Shut off Threshold	VBAT=3.7V, $R_{CS}=25m\Omega$ , $R_{IOST}=91k\Omega$		40	100	mA
Light Load Current Detect Time			16		s
HZ Pin High Voltage	HZ voltage rising		0.9	1.4	V
HZ Pin Low Voltage	HZ voltage falling	0.4	0.75		V
HZ Internal Pull-up Resistor			3		M $\Omega$
PB Turn off Boost Time	ACT2813		1.5		s
PB Turn on Boost Time			30		ms

## ELECTRICAL CHARACTERISTICS

( $V_{IN} = 5V$ ,  $T_A = 25^{\circ}C$ , unless otherwise specified.)

PARAMETER	TEST CONDITIONS	MIN	TYP	MAX	UNIT
<b>Mode Transition</b>					
Transition Waiting Time between Charge Mode and Boost Mode	TRANTIME		2		s
<b>Battery Level Indication</b>					
Battery Impedance Compensation Range		40		500	mΩ
Battery Impedance Compensation	$R_{CS}=25m\Omega$ , $R_{IMC}=200k\Omega$		200		mΩ
PB Deglitch Time			30		ms
PB High Input Voltage	PB voltage rising		0.9	1.4	V
PB Low Input Voltage	PB voltage falling	0.4	0.75		V
PB Internal Pull-up Resistor			3		MΩ
LED Indication Time	PB is pushed and released		5		s
LED Flash Frequency	Charging, LED flash 1s on and 1s off		0.5		Hz

FUNCTIONAL BLOCK DIAGRAM

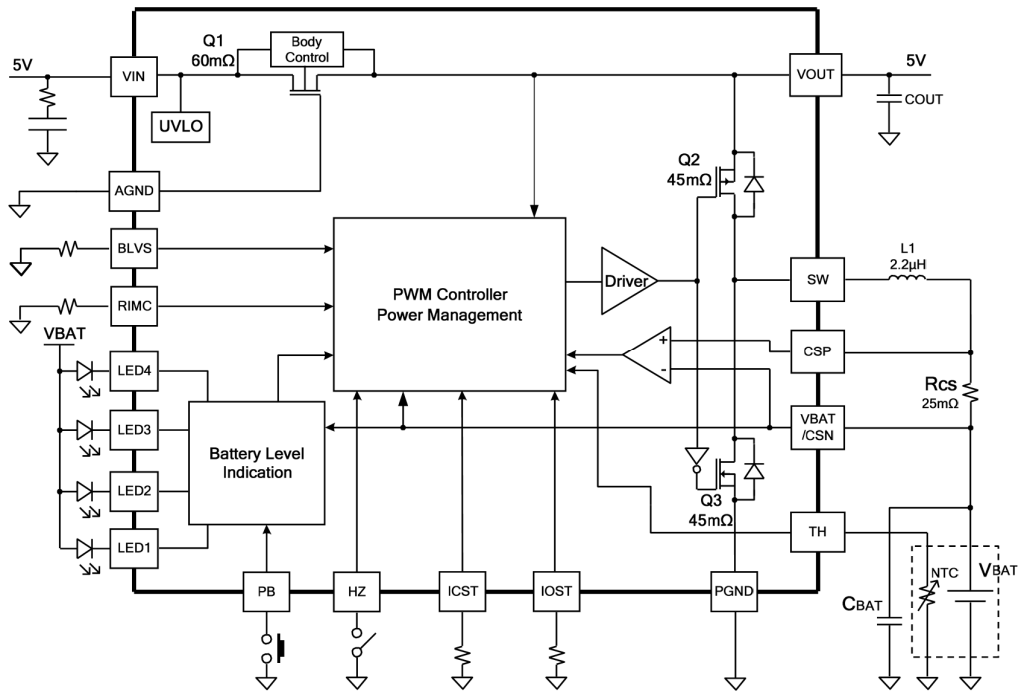



## FUNCTIONAL DESCRIPTION

ACT2813 is a complete battery charging and discharging power management solution for applications of single-cell lithium-based backup battery pack or power bank. There is a power path from input to output. If output voltage drops below 4.25V, the input switch Q1 turns off and restart in 2 seconds.

With the advanced ACT2813 architecture, a synchronous buck/boost converter is connected from VOUT to switching node (SW). With the bidirectional architecture, the converter could be configured as either buck to charge battery or boost to discharge battery. With switching charger and discharger, the higher charge current and higher conversion efficiency are achieved.

### Modes of Operation

ACT2813 has 3 operation modes: charge mode, boost mode and high-impedance (HZ) mode. In charge mode, the input current limit Q1 is enabled and Q2 and Q3 operate as a buck converter to charge battery. In boost mode, Q2 and Q3 operate as boost converter to step battery voltage up to +5V at VOUT, and the current limit switch Q1 is turned off, and the reverse current from VOUT to VIN is blocked. In HZ mode, all the switches are turned off and the drainage

current from battery is very low. ACT2813 system operation flow chart as shown in Figure 1.

Any transitions between boost mode and charge mode go through HZ mode by turning off all the switches Q1-Q3 into HZ mode for 2 seconds before enabling the other mode.

The modes are determined by HZ pin and VIN pin as shown in the table 1. A valid VIN voltage forces ACT2813 into charge mode. Boost mode is enabled if HZ pin is pulled low and VIN is invalid or not present. When HZ=0, if PB is pulled low for more than 30ms, boost converter is enabled. For ACT2813, a running boost is disabled if one of the following conditions is met:

1. Boost converter output current is below light load threshold for 16 seconds.
2. Battery voltage falls below the boost cut-off threshold.
3. After PB is released, if PB is pulled low for more than 1.5 seconds.

Table 1: Mode Selection

HZ PIN	0	0	1	1
VIN Valid	0	1	0	1
Mode	Boost	Charge	HZ	Charge

Figure 1:  
ACT2813 System Operation Flow Chart

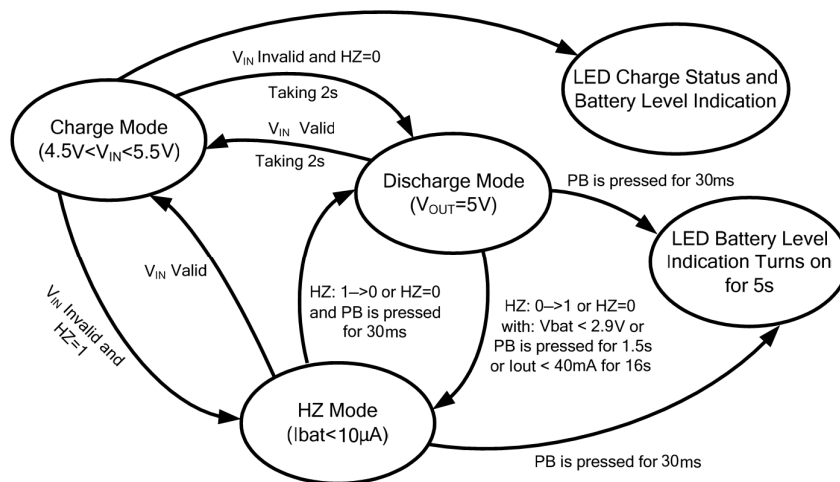

### Latch-Off

ACT2813 has latch off function. If discharging stops due to battery cut-off, and latch off will be triggered, it would prevent battery from discharging again, latch-off is released when input power is recycled.

### Switching Battery Charger

ACT2813 is configured in charge mode (buck mode) when VIN is valid. In this mode, the battery is charged with preconditioning, fast charge, top-off and end of charge (EOC). The typical charge management is shown in Figure 2 and Figure 3.

### CC/CV Regulation Loop

There are CC/CV regulation loops built in ACT2813, which regulates either current or voltage as necessary to ensure fast and safe charging of the battery. In a normal charge cycle, this loop regulates the current to the value set by the external resistor at the ICST pin. Charging continues at this current until the battery cell voltage reaches the termination voltage. At this point the CV loop takes over, and charge current is allowed to decrease as necessary to maintain charging at the termination voltage.

### Precondition Charge

A new charging cycle begins with the precondition state, and operation continues in this state until  $V_{BAT}$  exceeds the precondition threshold voltage. When operating in precondition state, the cell is charged at a reduced current, 10% of the programmed maximum fast charge constant current. Once  $V_{BAT}$  reaches the precondition threshold voltage the state machine jumps to the fast charge state.

### Fast Charge

If battery voltage is above preconditioning threshold, buck converter charges battery with constant current. In fast charge state, the ACT2813 charges at the current set by the external resistor connected at the ICST pin. During a normal charge cycle fast charge continues in CC mode until  $V_{BAT}$  reaches the charge termination voltage, at which point the ACT2813 charges in top off state.

### Top-Off

With the battery voltage approaches the EOC voltage, charge current decreases as charging continues. In the top off state, the cell is charged in constant voltage (CV) mode. During a normal charging cycle charging proceeds until the charge current decreases below the end of charge (EOC) threshold, defined as 15% of fast

charge current. When this happens, the state machine terminates the charge cycle and jumps to the EOC state.

### End of Charge

When charges current decreases to 15% of set fast charge current, the buck converter goes into end of charge mode and keep monitoring the battery voltage.

**Recharge**

When battery voltage drops by 200mV below the end of charge voltage, the charger is reinitiated with constant current charge

**Figure 2.**  
Typical Li+ Charge Profile and ACT2813 Charge States

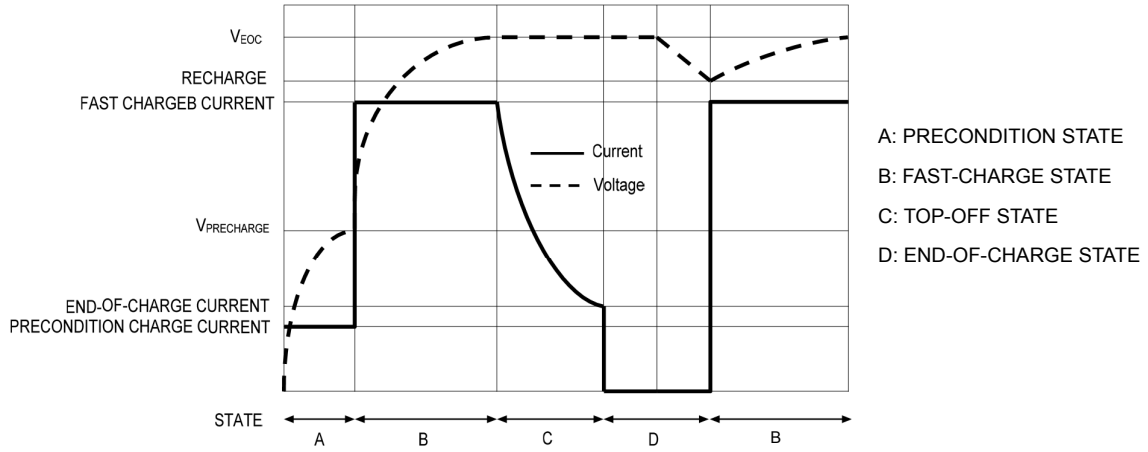

**Figure 3.**  
Charge States Diagram

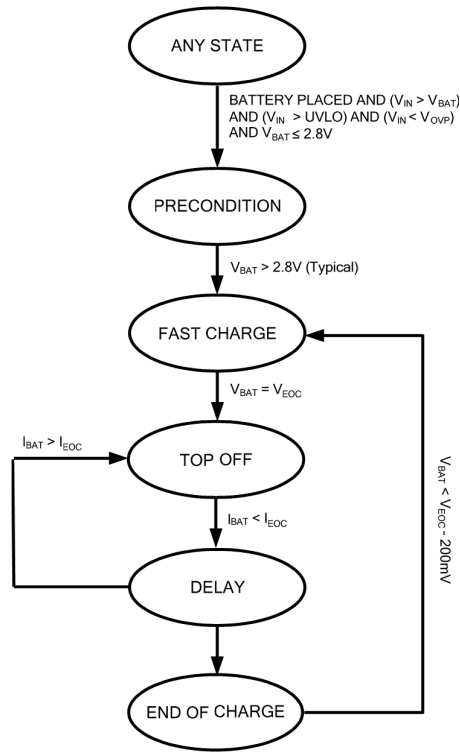

**APPLICATIONS INFORMATION**

**Battery level voltage shift (BLVS pin)**

LED1-4 voltage thresholds are adjusted from HZ mode during charging and discharging based on the compensated impedance. Those thresholds are programmed by a resistor connected from BLVS pin to AGND as shown in Figure 4. The following equation shows the LED4 voltage threshold:

$$V_{BATLED4} (V) = 3.5 (V) + 0.01 (mA) \times R_{BLVS} (k\Omega) \quad (1)$$

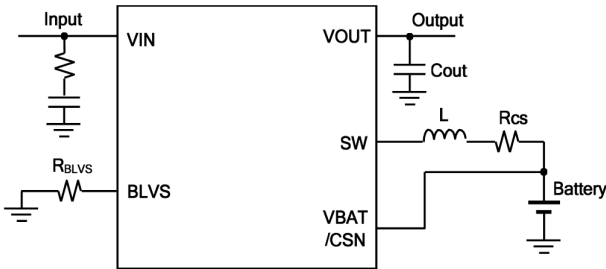

**Figure 4: Battery level voltage shift setting current**

As long as LED4 is set, all the other 3 LED thresholds is fixed as shown in the table 2:

**Table 2: 4 LED Voltage Thresholds**

R <sub>BLVS</sub> (ohm)	50k	60k	70k	80k
LED1	3.55V	3.65V	3.75V	3.85V
LED2	3.65V	3.75V	3.85V	3.95V
LED3	3.80V	3.90V	4.00V	4.10V
LED4	4.00V	4.10V	4.20V	4.30V

**LED Status Indication**

4 LEDs ON/OFF and flash show the charge status and the remained capacity level as shown in the table 3. The LED status is based on battery voltage and operation modes. When battery voltage is low, LED1 is flashing.

In charge mode, when a battery is fully charged, flashing stops and all the 4 LEDs are solid on.

**Fast Charge Current**

Battery fast charge current is set by a resistor connected from ICST pin to AGND as shown in Figure 5.

The battery fast charge current is estimated as the following equation:

$$I_c (A) = 1.25 (A) \times \frac{R_{ICST} (k\Omega)}{R_{cs} (m\Omega)} \quad (2)$$

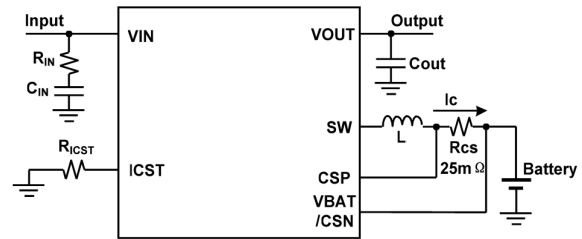

**Figure 5. Battery fast charge current setting circuit**

Figure 6 gives out different fast charge current with various RICST.

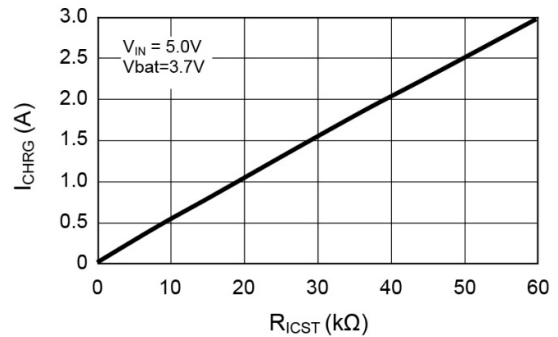

**Figure 6. Battery fast charge current setting**

Table 3. LED Indication

LED	Charge Mode				PB time>30ms (Boost or HZ Mode)			
	LED1	LED2	LED3	LED4	LED1	LED2	LED3	LED4
V <sub>BAT</sub> <2.9V	Flash	Off	Off	Off	Off	Off	Off	Off
2.9V≤V <sub>BAT</sub> <LED1	Flash	Off	Off	Off	Flash	Off	Off	Off
LED1≤V <sub>BAT</sub> <LED2	On	Flash	Off	Off	On	Off	Off	Off
LED2≤V <sub>BAT</sub> <LED3	On	On	Flash	Off	On	On	Off	Off
LED3≤V <sub>BAT</sub> <LED4	On	On	On	Flash	On	On	On	Off
V <sub>BAT</sub> ≥LED4	On	On	On	Flash	On	On	On	On
V <sub>BAT</sub> ≥LED4 (End of Charge)	On	On	On	On	On	On	On	On

**Boost Output Constant Current**

Boost output current is set by a resistor connected from IOST pin to AGND as shown in Figure 7. The boost output current is estimated as the following equation:

$$I_{IOST} (A) = \frac{2}{3} (A) \times \frac{R_{IOST} (k\Omega)}{Rcs (m\Omega)} \quad (3)$$

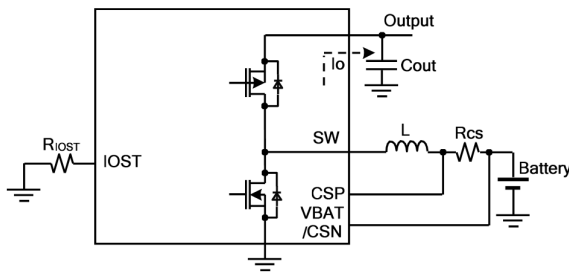

Figure 7. Boost Output current setting circuit

Figure 8 gives out boost output current with various R<sub>IOST</sub>.

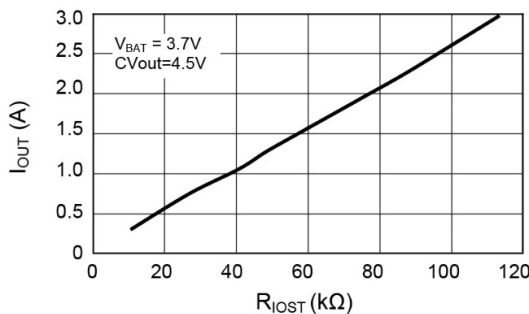

Figure 8. Boost Output current setting

The IOST pin voltage is proportional to output current until output current is limited, as shown in Figure 9.

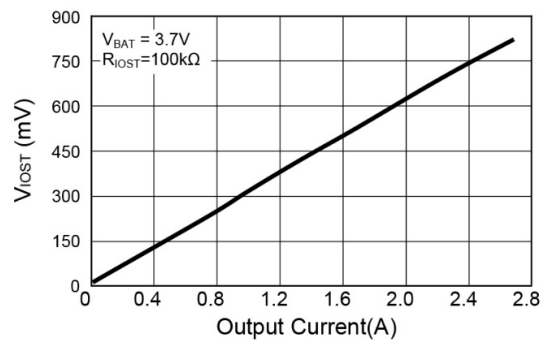

Figure 9. V<sub>IOST</sub> VS. output current

**Battery Impedance Compensation**

An external resistor is used to set the impedance from 40mΩ to 500mΩ as shown in Figure 10. R<sub>IMC</sub> is corresponding to battery impedance. Higher R<sub>IMC</sub> gives higher compensation voltage which is positively proportional to battery charge/discharge current.

Select R<sub>IMC</sub> based on battery impedance:

$$R_{IMC} (k\Omega) = \frac{25 \times R (k\Omega)}{Rcs (m\Omega)} \quad (4)$$

$$V_{BAT} (V) = BAT (V) - I_{BAT} (A) \times R (m\Omega) \times 10^{-3} \quad (5)$$

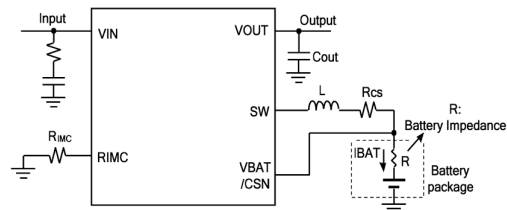

Figure 10. Battery impedance compensation setting circuit

The battery impedance as shown in the table 4 according to the R<sub>IMC</sub> and R<sub>CS</sub>:

Table 4: Battery Impedance

RIMC(KΩ)		50	100	200
Battery Impedance R(mΩ)	R <sub>CS</sub> =25mΩ	50	100	200
	R <sub>CS</sub> =50mΩ	100	200	400

**Boost Output Plug-in Auto Detection**

Figure 11 provides a solution for auto plug-in detection.

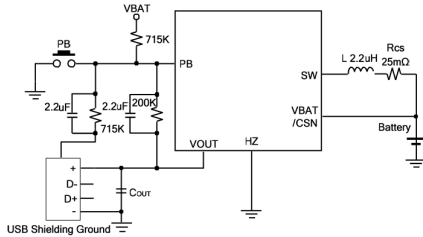

Figure 11: Boost output auto detection circuit

**External Input Over Voltage Protection**

Considering the maximum voltage rating at VIN pin, the external OVP circuit as shown in Figure 12 is recommended if input voltage may go higher than 7V. With the enhanced OVP circuit, the design can pass UN38.3.

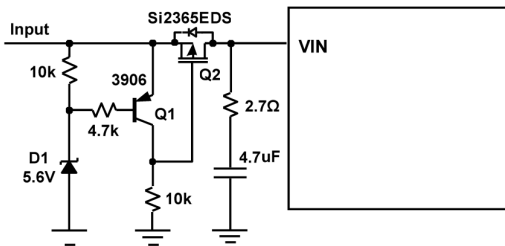

Figure 12. Input over voltage protection

**Input Over Voltage Surge**

In the case of pure ceramic input capacitor is chosen, if the input cable is long, stray inductance may cause over voltage spikes as twice as the steady-state voltage when input source is plugged in. Below input circuit is recommended to avoid input voltage surge. R1 resistor is added in series with capacitor C1 to damp the potential LC resonance as shown in Figure 13.

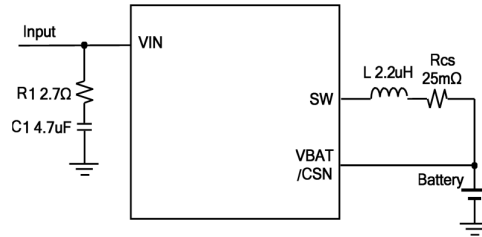

Figure 13. Input over voltage surge protection circuit

**Inductor and Capacitor Selection**

ACT2813 supports SMD components. 2.2uH inductor is recommended. Input side, 4.7uF ceramic capacitor in series with 2.7Ω resistor are recommended, on battery side, 22uF ceramic capacitors is recommended while on output side, 22uFx3 ceramic capacitors are recommended

**Battery Temperature Monitoring**

ACT2813 continuously monitors the temperature of the battery pack by sensing the resistance of its thermistor, and suspends charging if the temperature of the battery pack exceeds the safety limits.

In a typical application, the TH pin is connected to the battery pack's thermistor input as shown in Figure 14. The ACT2813 injects a 60μA current out of the TH pin into the thermistor, so that the thermistor resistance is monitored by comparing the voltage at TH to the internal V<sub>THL</sub> and V<sub>THH</sub> thresholds of 0.3V and 1.5V, respectively. When V<sub>TH</sub> > V<sub>THH</sub> or V<sub>TH</sub> < V<sub>THL</sub> charging and the charge timers are suspended. When V<sub>TH</sub> returns to the normal range, charging and the charge timers resume.

The threshold is given by:

$$60\mu A \times R_{NOM} \times k_{HOT} = 0.3V \rightarrow R_{NOM} \times k_{HOT} = 5k\Omega$$

$$60\mu A \times R_{NOM} \times k_{COLD} = 1.5V \rightarrow R_{NOM} \times k_{COLD} = 25k\Omega$$

where R<sub>NOM</sub> is the nominal thermistor resistance at room temperature, and k<sub>HOT</sub> and k<sub>COLD</sub> are the ratios of the thermistor's resistance at the desired hot and cold thresholds, respectively.

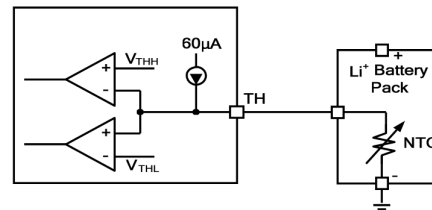

Figure 14. Battery thermal circuit

**PC Board Layout Guidance**

When laying out the printed circuit board, the following checklist should be used to ensure proper operation of the IC.

- 1) Arrange the power components to reduce the AC loop size, VIN pin, Vout pin, SW pin and the schottky diode.
- 2) Place input decoupling ceramic capacitor C1 and R9 as close to VIN pin as possible. Resistor R9 is added in series with capacitor C1 to damp the potential LC resonance
- 3) Use copper plane for power GND for best heat dissipation and noise immunity.

- 4) Place CSP and CSN capacitor C7 (10nF) close to CSP and CSN pin as possible, use Kevin Sense from sense resistor R1 and R2 to CSP and CSN pins. 22uF decoupling capacitor is added close to VBAT pin.
- 5) Place the ceramic capacitor C2 and D1 as close to VOUT and PGND as possible, SW goes under the C2 (recommend C2 to use 1206 size). SW pad is a noisy node switching. It should be isolated away from the rest of circuit for good EMI and low noise operation.
- 6) RC snubber is recommended to add across SW to PGND to reduce EMI noise.

A demo board PCB layout example is shown in the figure 15.

**Figure 15. PCB Layout**

Top Layer

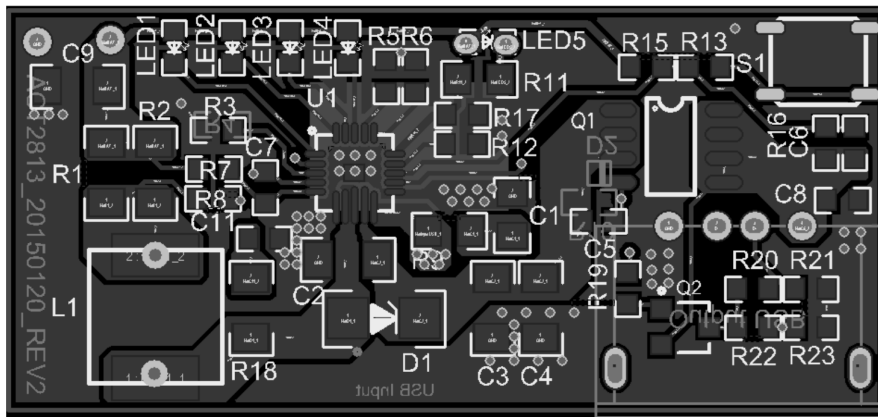

Bottom Layer

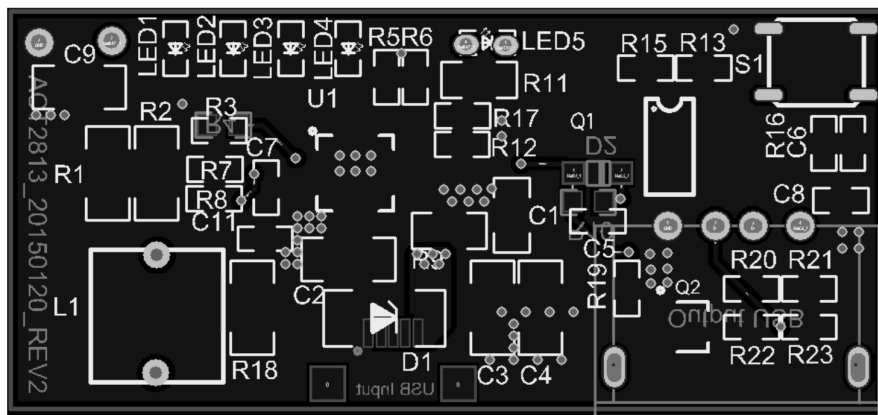

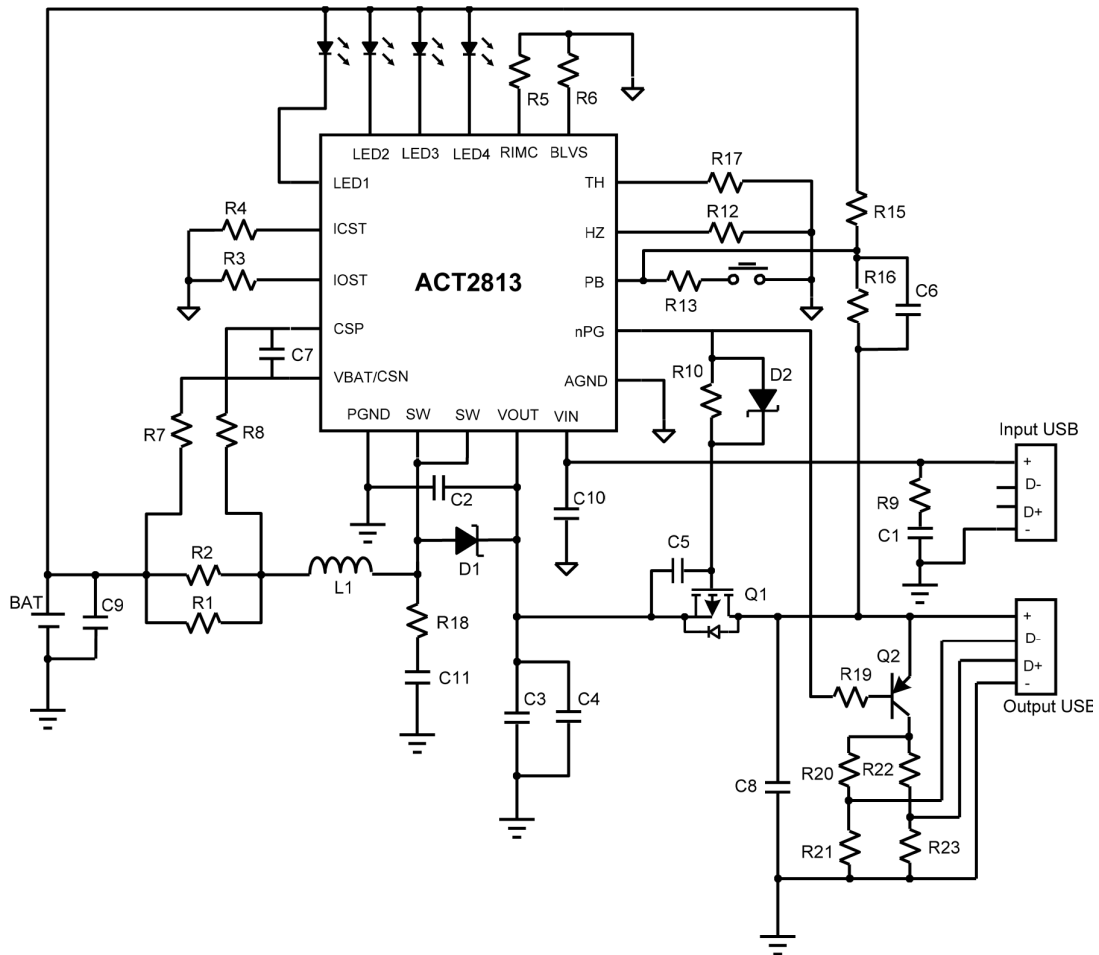

Figure 16. ACT2813 typical application circuit

(Fast charge current set is 2.4A, boost output constant current set is 2.66A)

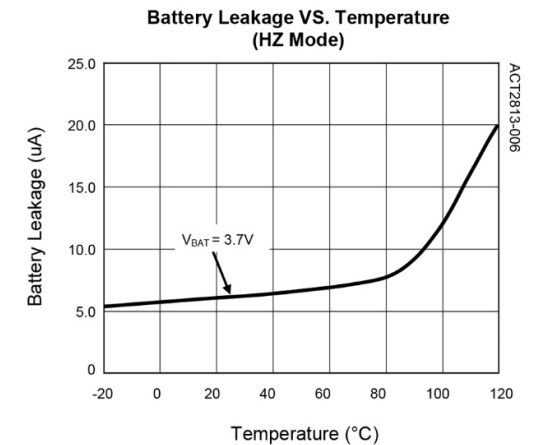
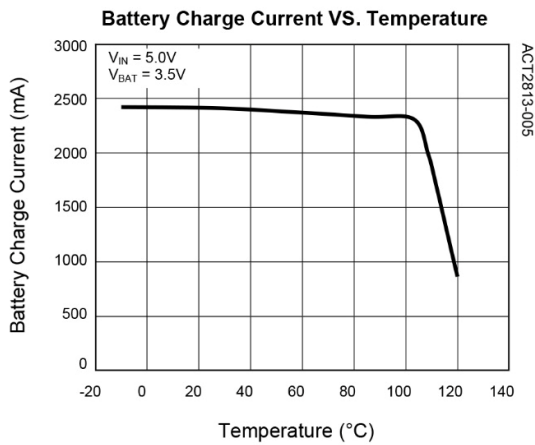
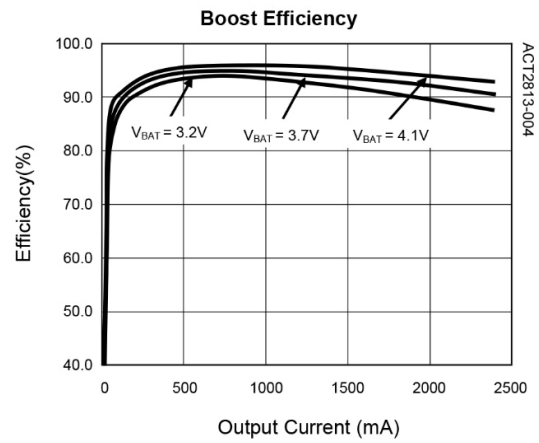
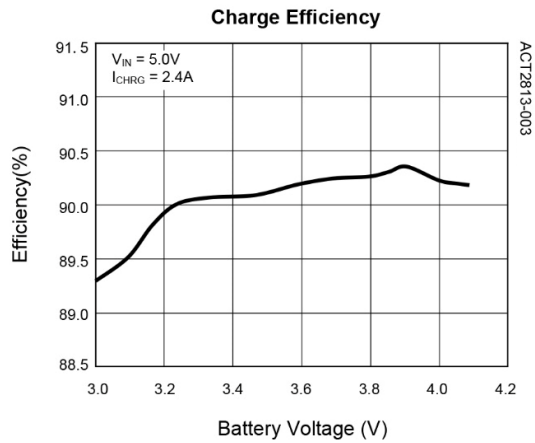
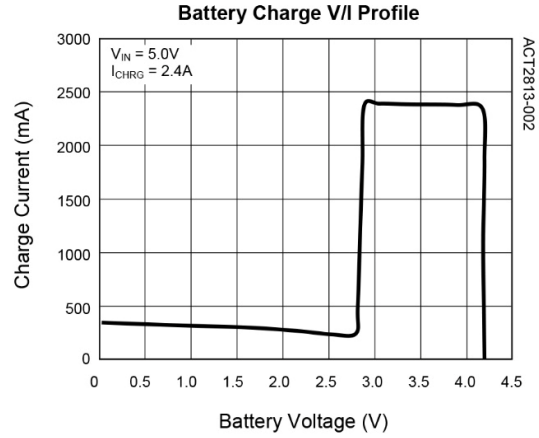
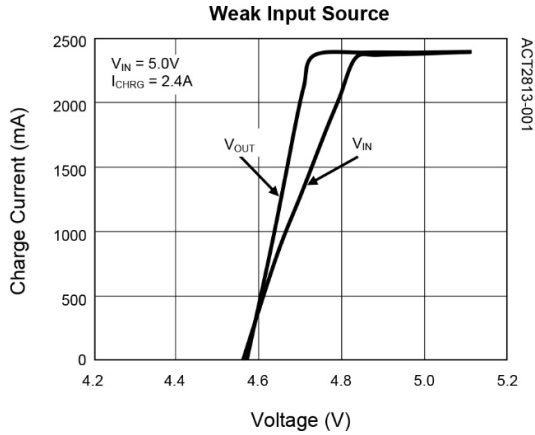

**Table 5: BOM List**

ITEM	REFERENCE	DESCRIPTION	QTY	MANUFACTURER
1	L1	Core, 6.5*3*3 Dip, 2.2uH, 6A, Rdson=5mΩ	1	Sunlord
2	Q1	AO4503, Rdson=19mΩ at VGS = - 4.5 V	1	AOS
3	Q2	MMBT3906	1	Murata/TDK
4	D1	SBR3U20SA, 20V/3A Schottky MBRA210LT3G, 10V/2A Schottky	1	Diodes On-semi
5	D2	1N4148, Vf=0.7V, 75V Schottky	1	Murata/TDK
6	C1	Ceramic capacitor, 4.7uF/10V, X7R, 0805	1	Murata/TDK
7	C2,C3,C4,C9	Ceramic capacitor, 22uF/10V, X7R, 1206	4	Murata/TDK
8	C5,C6	Ceramic capacitor, 2.2uF/10V, X7R, 0603	2	Murata/TDK
9	C7	Ceramic capacitor, 10nF/10V, X7R, 0603	1	Murata/TDK
10	C8	Ceramic capacitor, 0.1uF/10V, X7R, 0603	1	Murata/TDK
11	C10	Ceramic capacitor, 10uF/10V, X7R, 0805	1	Murata/TDK
12	C11	Ceramic capacitor, 4.7nF/10V, X7R, 0603	1	Murata/TDK
13	R1,R2	Chip Resistor, 50mΩ, 1/4W, 1%, 1206	2	SART
14	R3,R10	Chip Resistor, 100kΩ, 1/10W, 1%, 0603	2	Murata/TDK
15	R4	Chip Resistor, 48kΩ, 1/10W, 1%, 0603	1	Murata/TDK
16	R5	Chip Resistor, 68kΩ, 1/10W, 5%, 0603	1	Murata/TDK
17	R6	Chip Resistor, 60.4kΩ, 1/10W, 1%, 0603	1	Murata/TDK
18	R7,R8,R12	Chip Resistor, 0Ω, 1/10W, 1%, 0603	3	Murata/TDK
19	R9	Chip Resistor, 2.7Ω, 1/8W, 1%, 0805	1	Murata/TDK
20	R13	Chip Resistor, 100Ω, 1/10W, 1%, 0603	1	Murata/TDK
21	R15	Chip Resistor, 715kΩ, 1/10W, 5%, 0603	1	Murata/TDK
22	R16,R19	Chip Resistor, 200kΩ, 1/10W, 5%, 0603	2	Murata/TDK
23	R17	Chip Resistor, 10kΩ, 1/10W, 5%, 0603	1	Murata/TDK
24	R18	Chip Resistor, 0.47Ω, 1/4W, 1%, 1206	1	Murata/TDK
25	R20,R22	Chip Resistor, 43.2kΩ, 1/10W, 1%, 0603	2	Murata/TDK
26	R21,R23	Chip Resistor, 49.9kΩ, 1/10W, 1%, 0603	2	Murata/TDK
27	LED1, LED2, LED3, LED4	LED, 0603, Blue	4	LED Manu
28	PB	Push Button	1	LED Manu
29	USB	10.2*14.6*7mm, 4P, DIP	1	
30	Micro-USB	MICRO USB 5P/F SMT B	1	
31	U1	IC, ACT2813QY, FCQFN 4x4-20	1	Qorvo

TYPICAL PERFORMANCE CHARACTERISTICS

(Schematic as shown in Figure 16, Ta = 25°C, unless otherwise specified)



TYPICAL PERFORMANCE CHARACTERISTICS CONT'D

(Schematic as shown in Figure 16, Ta = 25°C, unless otherwise specified)

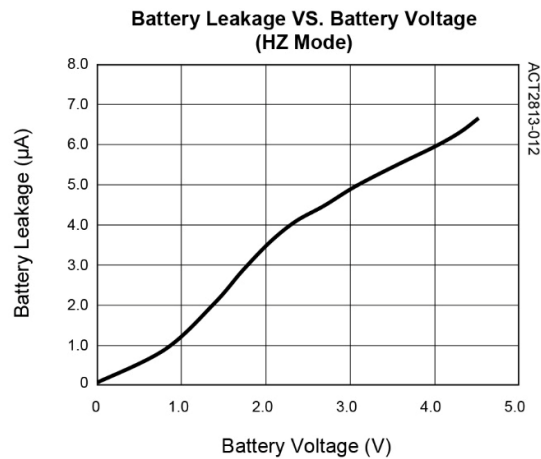
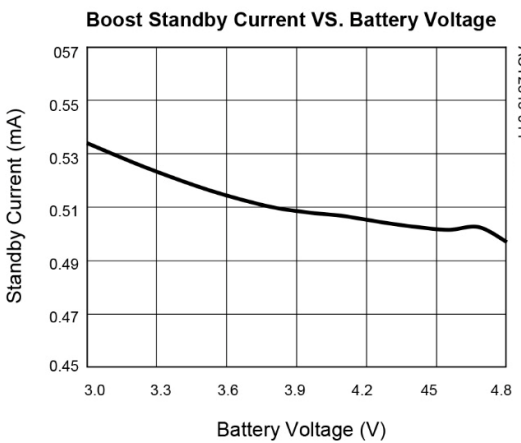
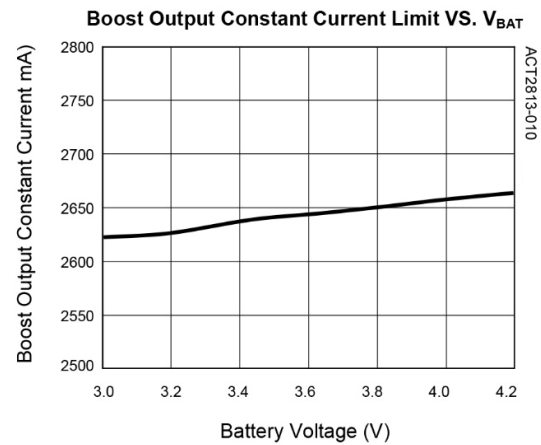
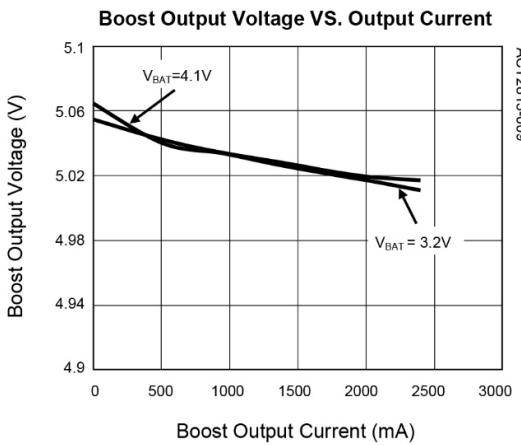
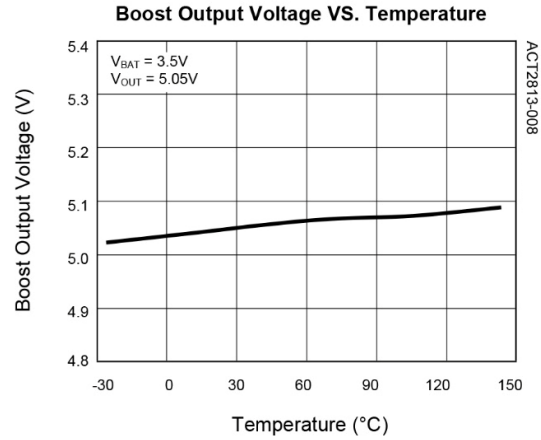
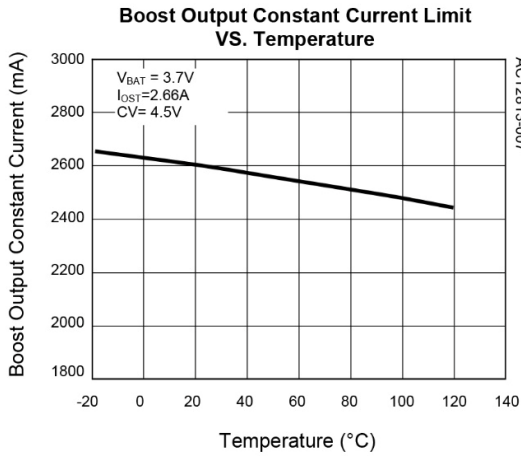

TYPICAL PERFORMANCE CHARACTERISTICS CONT'D

(Schematic as shown in Figure 16, Ta = 25°C, unless otherwise specified)

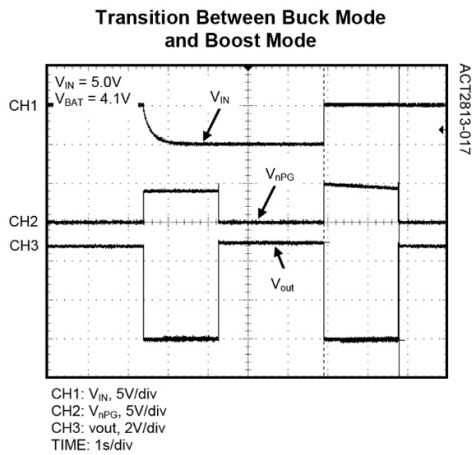
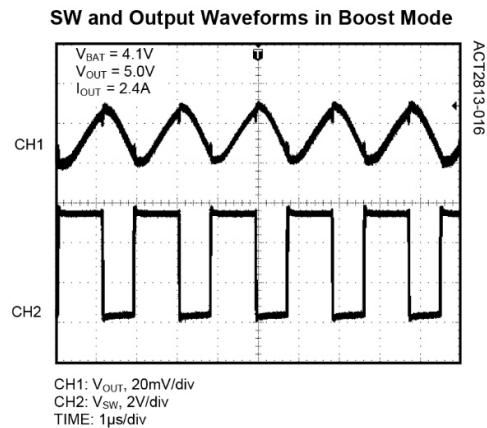
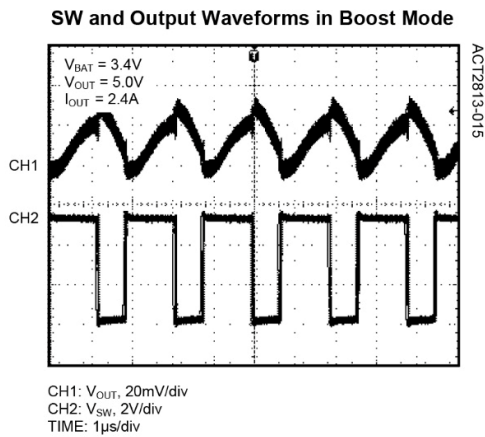
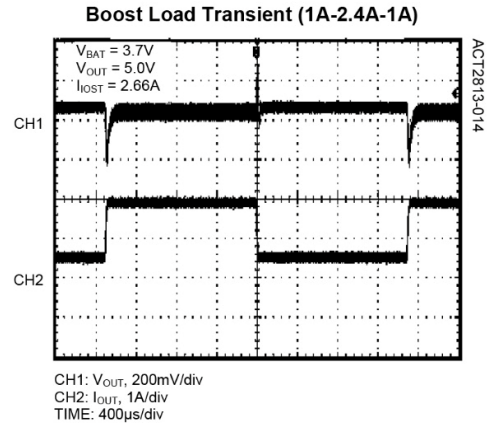
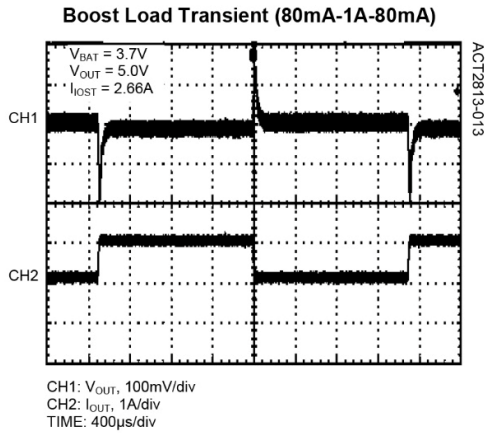

**PACKAGE OUTLINE**

**QFN55-40 PACKAGE OUTLINE AND DIMENSIONS**

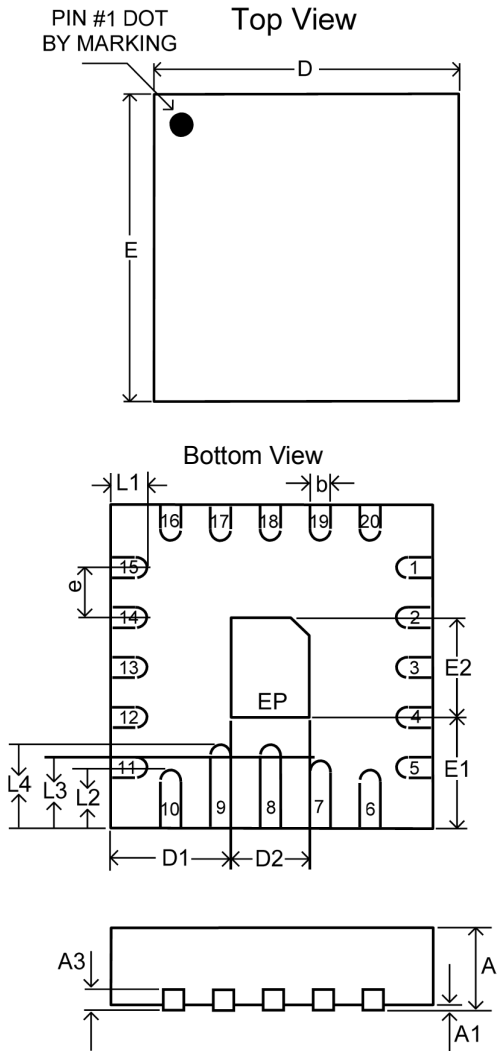

SYMBOL	DIMENSION IN MILLIMETERS		DIMENSION IN INCHES	
	MIN	MAX	MIN	MAX
A	0.800	0.900	0.031	0.035
A1	—	0.050	—	0.002
A3	0.203 REF		0.008 REF	
b	0.200	0.300	0.008	0.012
D	3.950	4.050	0.156	0.159
D1	1.550	1.650	0.061	0.065
D2	0.750	0.850	0.030	0.033
e	0.500 BSC		0.020 BSC	
E	3.950	4.050	0.156	0.159
E1	1.450	1.550	0.057	0.061
E2	0.950	1.050	0.037	0.041
L1	0.450	0.550	0.018	0.022
L2	0.950	1.050	0.037	0.041
L3	1.050	1.150	0.041	0.045
L4	1.200	1.300	0.047	0.051

## Product Compliance

---

This part complies with RoHS directive 2011/65/EU as amended by (EU) 2015/863.

This part also has the following attributes:

- Lead Free
- Halogen Free (Chlorine, Bromine)



## Contact Information

---

For the latest specifications, additional product information, worldwide sales and distribution locations:

**Web:** [www.qorvo.com](http://www.qorvo.com)

**Tel:** 1-844-890-8163

**Email:** [customer.support@qorvo.com](mailto:customer.support@qorvo.com)

For technical questions and application information:

**Email:** [appsupport@qorvo.com](mailto:appsupport@qorvo.com)

## Important Notice

---

The information contained herein is believed to be reliable; however, Qorvo makes no warranties regarding the information contained herein and assumes no responsibility or liability whatsoever for the use of the information contained herein. All information contained herein is subject to change without notice. Customers should obtain and verify the latest relevant information before placing orders for Qorvo products. The information contained herein or any use of such information does not grant, explicitly or implicitly, to any party any patent rights, licenses, or any other intellectual property rights, whether with regard to such information itself or anything described by such information. **THIS INFORMATION DOES NOT CONSTITUTE A WARRANTY WITH RESPECT TO THE PRODUCTS DESCRIBED HEREIN, AND QORVO HEREBY DISCLAIMS ANY AND ALL WARRANTIES WITH RESPECT TO SUCH PRODUCTS WHETHER EXPRESS OR IMPLIED BY LAW, COURSE OF DEALING, COURSE OF PERFORMANCE, USAGE OF TRADE OR OTHERWISE, INCLUDING THE IMPLIED WARRANTIES OF MERCHANTABILITY AND FITNESS FOR A PARTICULAR PURPOSE.**

Without limiting the generality of the foregoing, Qorvo products are not warranted or authorized for use as critical components in medical, life-saving, or life-sustaining applications, or other applications where a failure would reasonably be expected to cause severe personal injury or death.

Copyright 2019 © Qorvo, Inc. | Qorvo® and Active-Semi® are trademarks of Qorvo, Inc.