

# CR03AM-16A

800V-0.3A-Thyristor

Low Power Use

R07DS0987EJ0400

Rev.4.00

Aug 25, 2015

## Features

- $I_{T(AV)}$  : 0.3 A
- $V_{DRM}$  : 800 V
- $I_{GT}$ : 100  $\mu$ A
- RoHS Compliant
- Non-Insulated Type
- Planar Passivation Type
- Halogen-free package (PRSS0003DJ-A)
- Completely Pb-free package (PRSS0003DJ-A)

## Outline

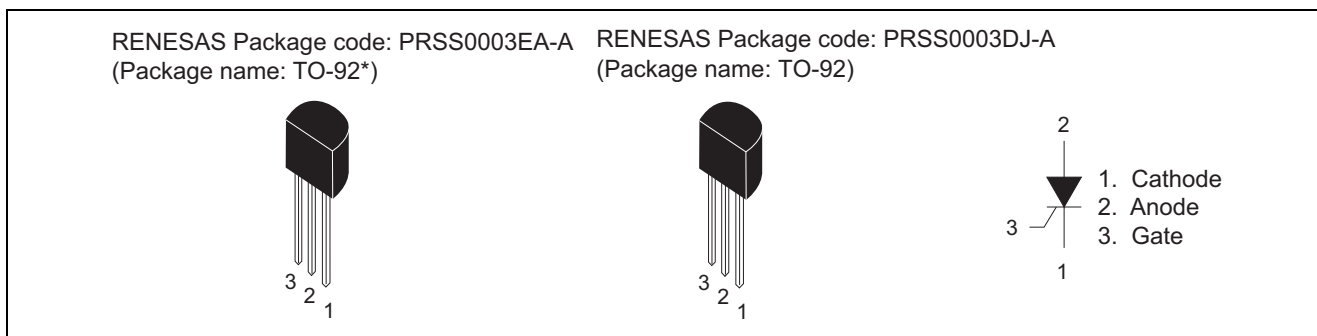

## Applications

Leakage protector, timer, and gas igniter

## Maximum Ratings

Parameter	Symbol	Voltage class	Unit
		16	
Repetitive peak reverse voltage	$V_{RRM}$	800	V
Non-repetitive peak reverse voltage	$V_{RSM}$	960	V
DC reverse voltage	$V_{R(DC)}$	640	V
Repetitive peak off-state voltage <sup>Note1</sup>	$V_{DRM}$	800	V
Non-repetitive peak off-state voltage <sup>Note1</sup>	$V_{DSM}$	960	V
DC off-state voltage <sup>Note1</sup>	$V_{D(DC)}$	640	V

Notes: 1. With gate to cathode resistance  $R_{GK} = 1\text{ k}\Omega$

Parameter	Symbol	Ratings	Unit	Conditions
RMS on-state current	$I_{T(RMS)}$	0.47	A	
Average on-state current	$I_{T(AV)}$	0.3	A	Commercial frequency, sine half wave 180° conduction, $T_a=62^\circ\text{C}$
Surge on-state current	$I_{TSM}$	20	A	60Hz sine half wave, 1full cycle, peak value, non-repetitive
$I^2t$ for fusing	$I^2t$	1.6	$\text{A}^2\text{s}$	Value corresponding to 1cycle of half wave 60Hz, surge on-state current
Peak gate power dissipation	$P_{GM}$	0.5	W	
Average gate power dissipation	$P_{G(AV)}$	0.1	W	
Peak gate forward voltage	$V_{FGM}$	6	V	
Peak gate reverse voltage	$V_{RGM}$	6	V	
Peak gate forward current	$I_{FGM}$	0.3	A	
Junction temperature	$T_j$	- 40 to +125	$^\circ\text{C}$	
Storage temperature	$T_{stg}$	- 40 to +125	$^\circ\text{C}$	
Mass	—	0.23	g	Typical value

### Electrical Characteristics

Parameter	Symbol	Min.	Typ.	Max.	Unit	Test conditions
Repetitive peak reverse current	$I_{RRM}$	—	—	0.1	mA	$T_j = 125^\circ\text{C}$ , $V_{RRM}$ applied
Repetitive peak off-state current	$I_{DRM}$	—	—	0.1	mA	$T_j = 125^\circ\text{C}$ , $V_{DRM}$ applied $R_{GK} = 1\text{ k}\Omega$
On-state voltage	$V_{TM}$	—	—	1.8	V	$T_j = 25^\circ\text{C}$ , $I_{TM} = 4\text{ A}$ instantaneous value
Gate trigger voltage	$V_{GT}$	—	—	0.8	V	$T_j = 25^\circ\text{C}$ , $V_D = 6\text{ V}$ , $I_T = 0.1\text{ A}$ <sup>Note3</sup>
Gate non-trigger voltage	$V_{GD}$	0.2	—	—	V	$T_j = 125^\circ\text{C}$ , $V_D = 1/2 V_{DRM}$ $R_{GK} = 1\text{ k}\Omega$
Gate trigger current	$I_{GT}$	1 <sup>Note2</sup>	—	100 <sup>Note2</sup>	$\mu\text{A}$	$T_j = 25^\circ\text{C}$ , $V_D = 6\text{ V}$ , $I_T = 0.1\text{ A}$ <sup>Note3</sup>
Holding current	$I_H$	—	—	3	mA	$T_j = 25^\circ\text{C}$ , $V_D = 12\text{ V}$ , $R_{GK} = 1\text{ k}\Omega$
Thermal resistance	$R_{th(j-a)}$	—	—	180	$^\circ\text{C/W}$	Junction to ambient

Notes: 2. If special values of  $I_{GT}$  are required, choose item A, B, D or E from those listed in the table below if possible.

Item	A	B	D	E
$I_{GT}$ ( $\mu\text{A}$ )	1 to 30	20 to 50	1 to 50	20 to 100

The above values do not include the current flowing through the  $1\text{ k}\Omega$  resistance between the gate and cathode.

3.  $I_{GT}$ ,  $V_{GT}$  measurement circuit.

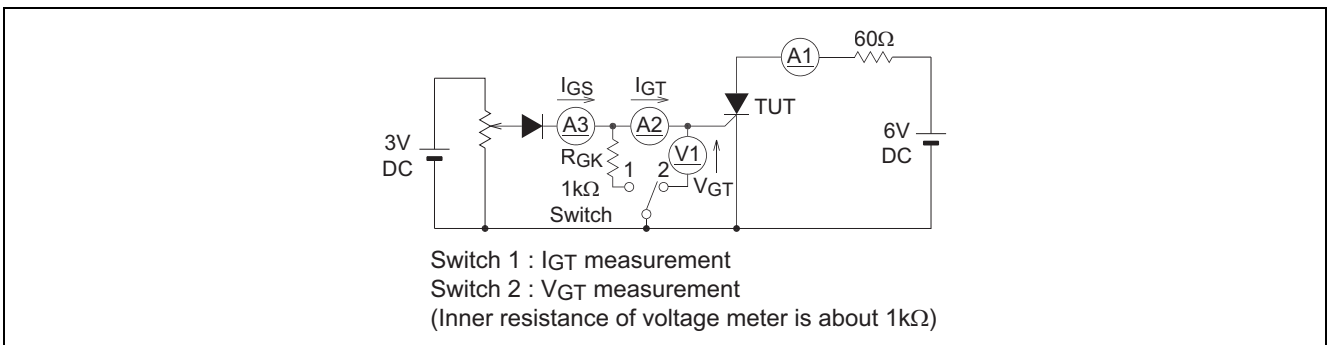

Performance Curves

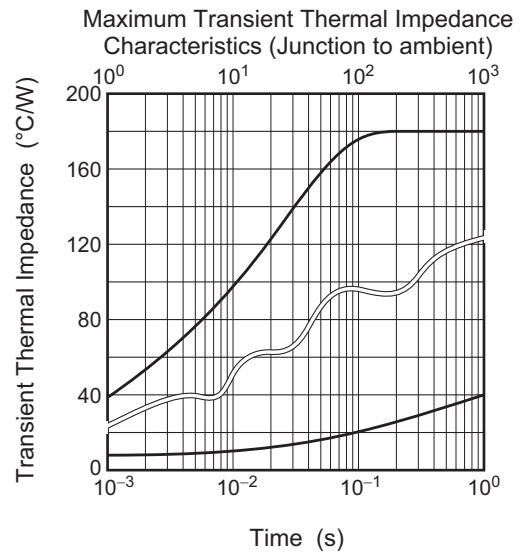
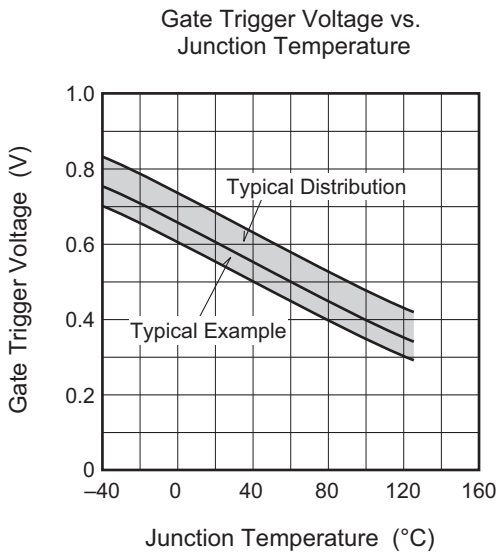
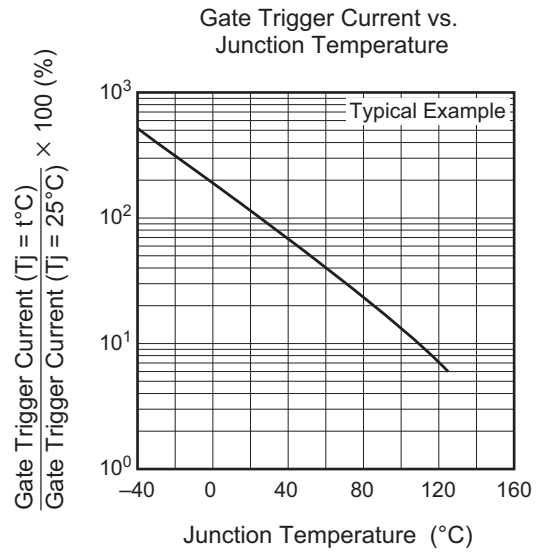
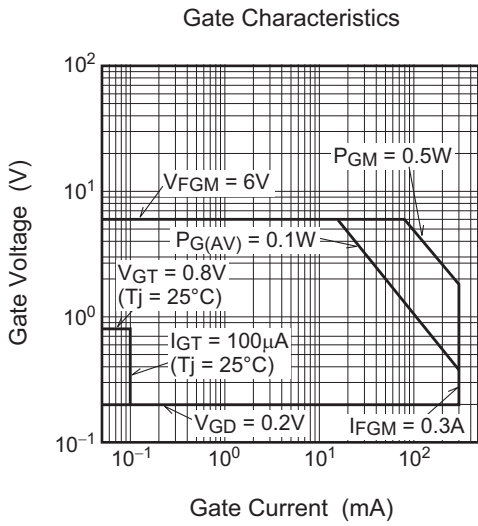
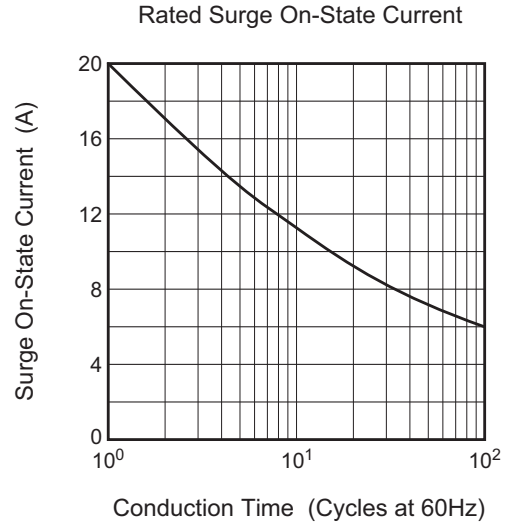
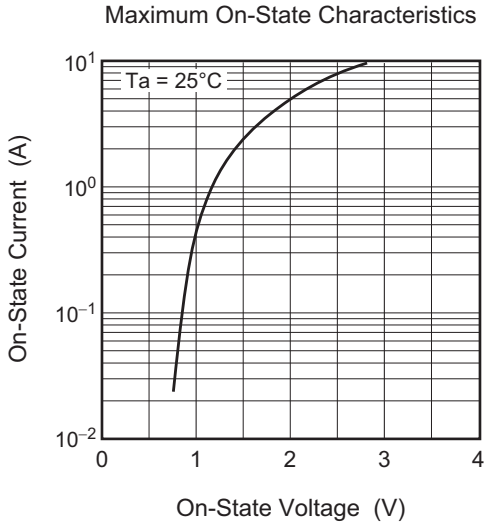

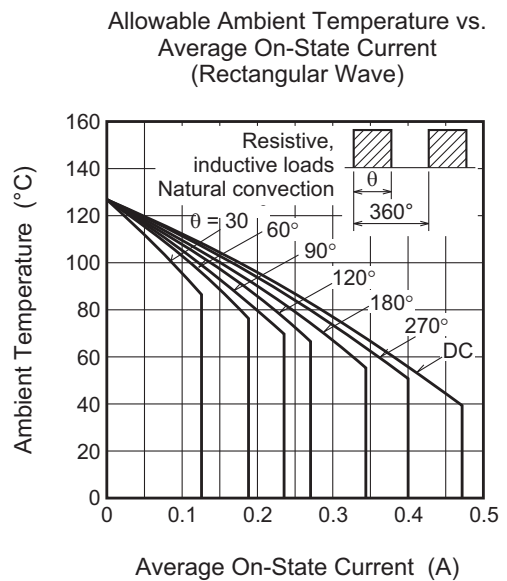
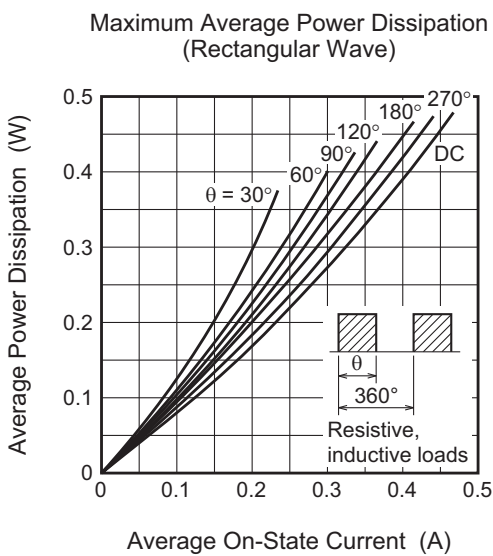
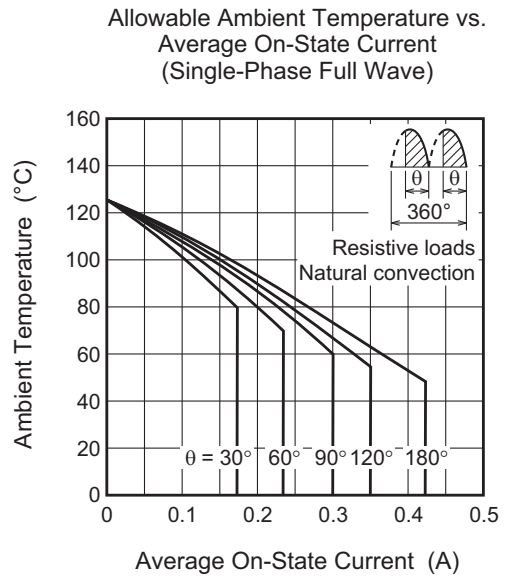
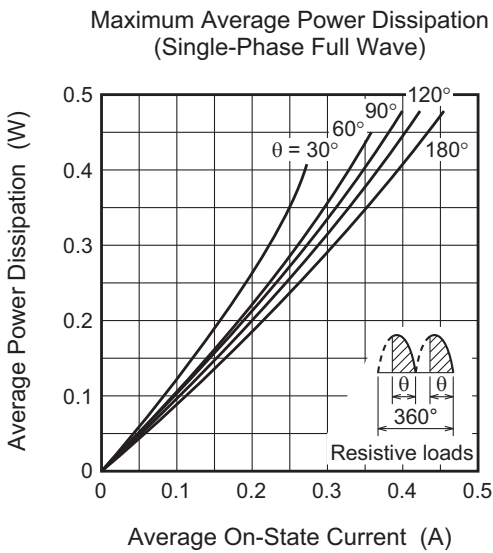
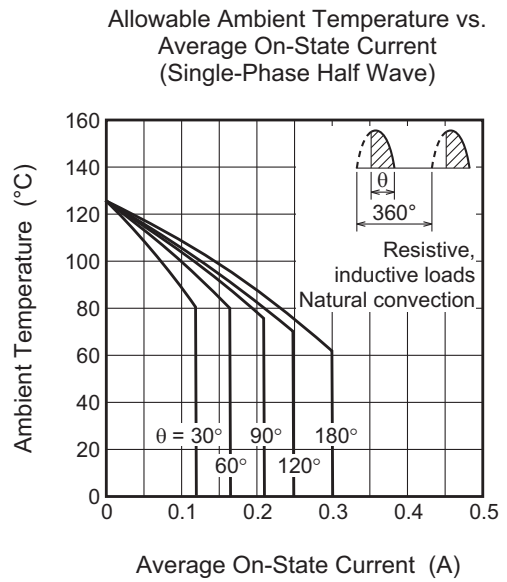
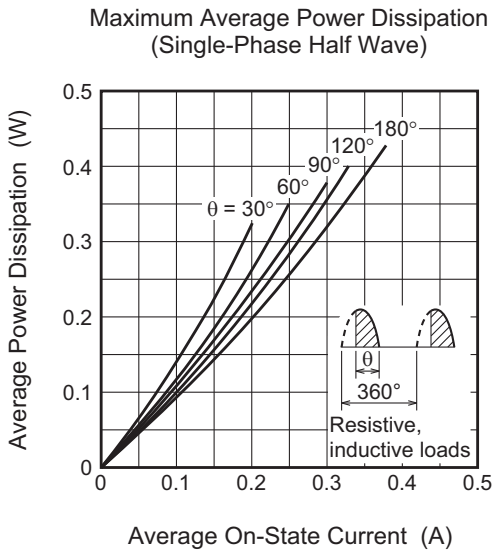

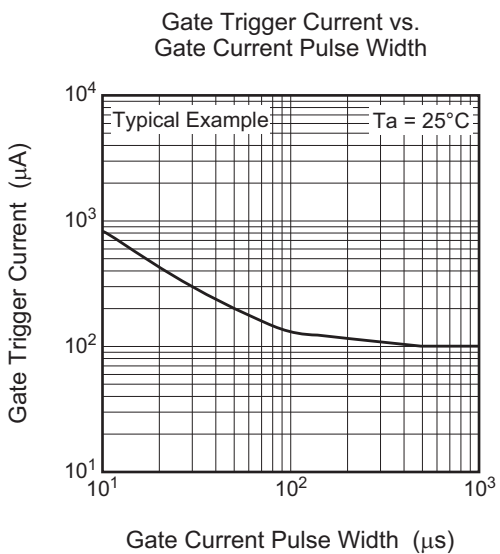
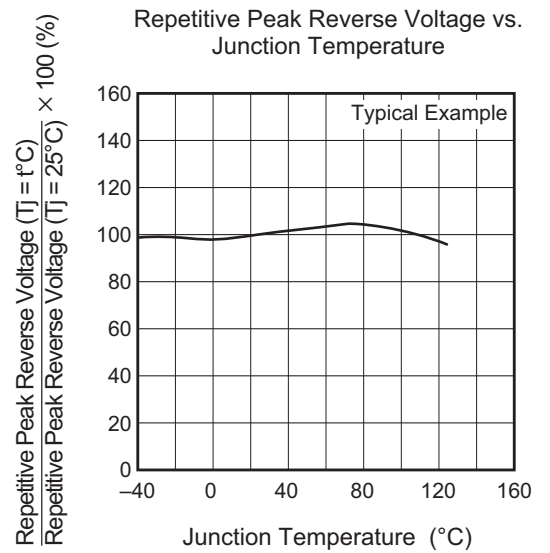
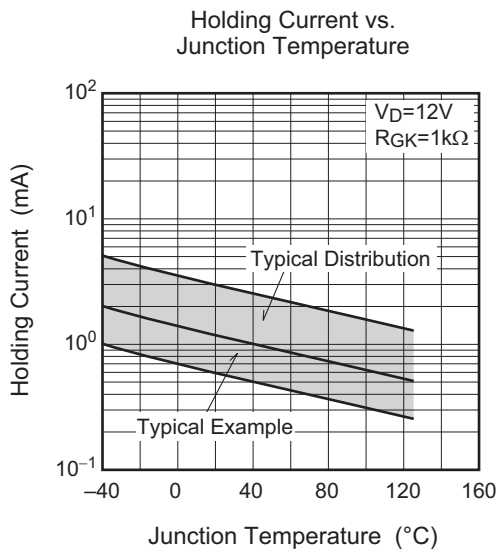
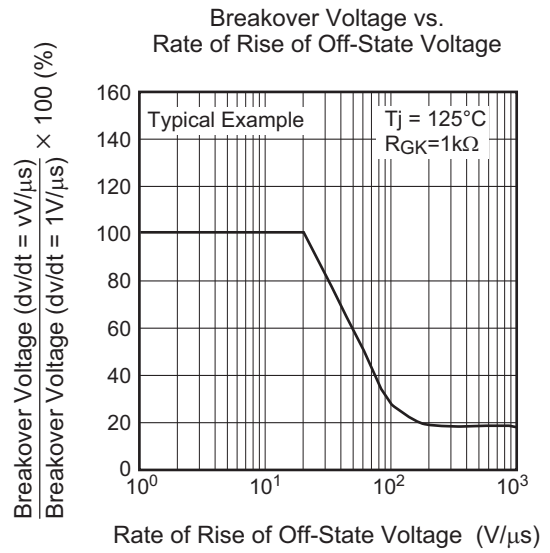
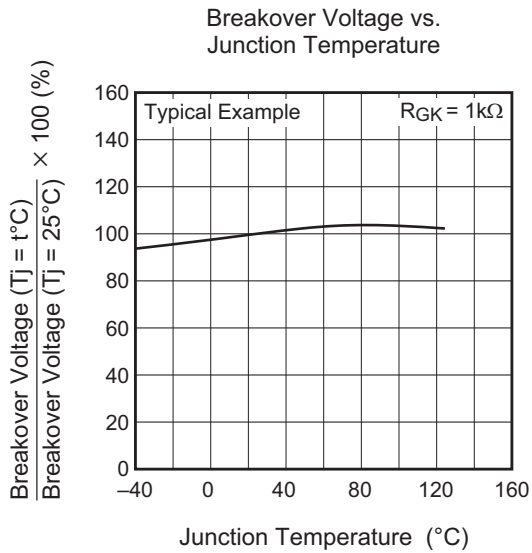

Package dimensions

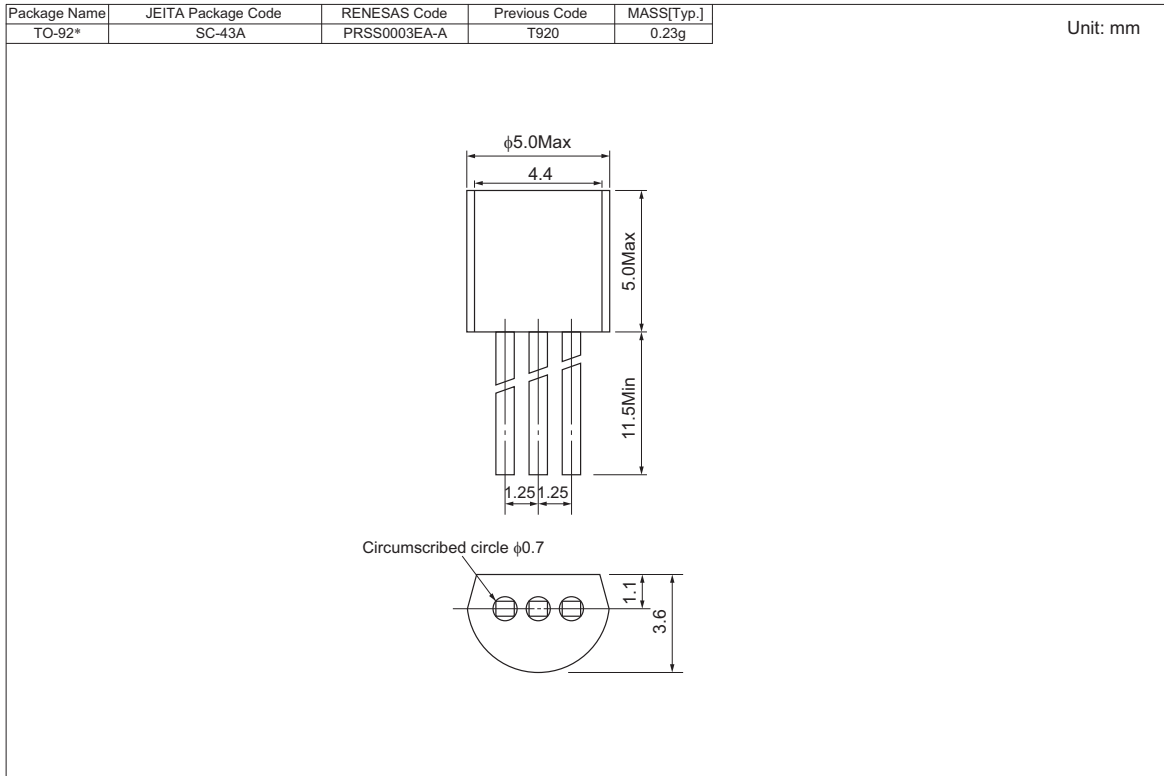

JEITA Package Code	RENESAS Code	Previous Code	MASS (Typ) [g]
SC-43A	PRSS0003DJ-A	TO-92	0.23

Unit: mm

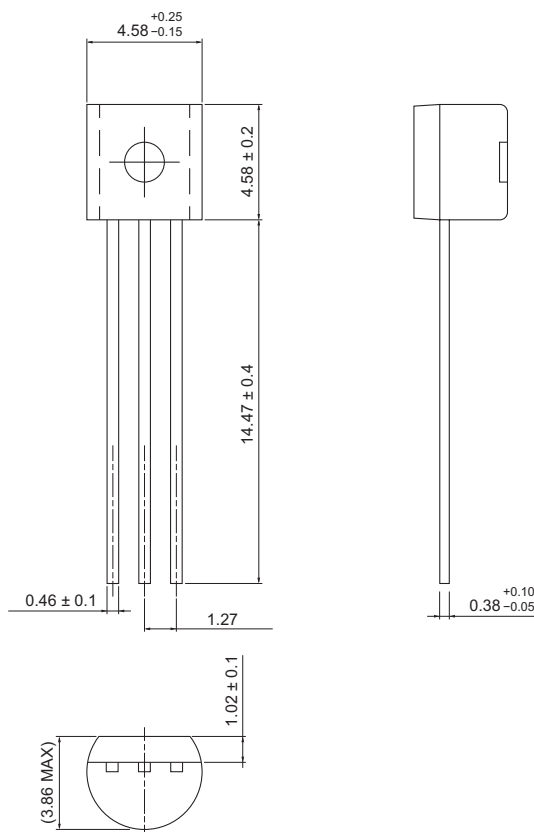

## Ordering Information

Orderable Part Number	Package	Packing <sup>Note</sup>	Quantity	Remark
CR03AM-16A#B00	TO-92*	Plastic Bag	500 pcs.	Straight type
CR03AM-16A-□#B00	TO-92*	Plastic Bag	500 pcs.	Straight type, □:IGT item
CR03AM-16A-A6#B00	TO-92*	Plastic Bag	500 pcs.	A6 Lead form
CR03AM-16A-TB#B00	TO-92*	Adhesive Tape	2000 pcs.	A8 Lead form
CR03AM-16A-□TB#B00	TO-92*	Adhesive Tape	2000 pcs.	A8 Lead form, □:IGT item
CR03AM-16A #BD0	TO-92	Plastic Bag	1000 pcs.	Straight type, Halogen-free
CR03AM-16A-□#BD0	TO-92	Plastic Bag	1000 pcs.	Straight type, Halogen-free, □:IGT item
CR03AM-16A-A6#BD0	TO-92	Plastic Bag	1000 pcs.	A6 Lead form, Halogen-free
CR03AM-16A-TB#BD0	TO-92	Adhesive Tape	2000 pcs.	A8 Lead form, Halogen-free
CR03AM-16A-□TB#BD0	TO-92	Adhesive Tape	2000 pcs.	A8 Lead form, Halogen-free, □:IGT item

Note : Please confirm the specification about the shipping in detail.

## Notice

1. Descriptions of circuits, software and other related information in this document are provided only to illustrate the operation of semiconductor products and application examples. You are fully responsible for the incorporation of these circuits, software, and information in the design of your equipment. Renesas Electronics assumes no responsibility for any losses incurred by you or third parties arising from the use of these circuits, software, or information.
2. Renesas Electronics has used reasonable care in preparing the information included in this document, but Renesas Electronics does not warrant that such information is error free. Renesas Electronics assumes no liability whatsoever for any damages incurred by you resulting from errors in or omissions from the information included herein.
3. Renesas Electronics does not assume any liability for infringement of patents, copyrights, or other intellectual property rights of third parties by or arising from the use of Renesas Electronics products or technical information described in this document. No license, express, implied or otherwise, is granted hereby under any patents, copyrights or other intellectual property rights of Renesas Electronics or others.
4. You should not alter, modify, copy, or otherwise misappropriate any Renesas Electronics product, whether in whole or in part. Renesas Electronics assumes no responsibility for any losses incurred by you or third parties arising from such alteration, modification, copy or otherwise misappropriation of Renesas Electronics product.
5. Renesas Electronics products are classified according to the following two quality grades: "Standard" and "High Quality". The recommended applications for each Renesas Electronics product depends on the product's quality grade, as indicated below.  
"Standard": Computers; office equipment; communications equipment; test and measurement equipment; audio and visual equipment; home electronic appliances; machine tools; personal electronic equipment; and industrial robots etc.  
"High Quality": Transportation equipment (automobiles, trains, ships, etc.); traffic control systems; anti-disaster systems; anti-crime systems; and safety equipment etc.  
Renesas Electronics products are neither intended nor authorized for use in products or systems that may pose a direct threat to human life or bodily injury (artificial life support devices or systems, surgical implantations etc.), or may cause serious property damages (nuclear reactor control systems, military equipment etc.). You must check the quality grade of each Renesas Electronics product before using it in a particular application. You may not use any Renesas Electronics product for any application for which it is not intended. Renesas Electronics shall not be in any way liable for any damages or losses incurred by you or third parties arising from the use of any Renesas Electronics product for which the product is not intended by Renesas Electronics.
6. You should use the Renesas Electronics products described in this document within the range specified by Renesas Electronics, especially with respect to the maximum rating, operating supply voltage range, movement power voltage range, heat radiation characteristics, installation and other product characteristics. Renesas Electronics shall have no liability for malfunctions or damages arising out of the use of Renesas Electronics products beyond such specified ranges.
7. Although Renesas Electronics endeavors to improve the quality and reliability of its products, semiconductor products have specific characteristics such as the occurrence of failure at a certain rate and malfunctions under certain use conditions. Further, Renesas Electronics products are not subject to radiation resistance design. Please be sure to implement safety measures to guard them against the possibility of physical injury, and injury or damage caused by fire in the event of the failure of a Renesas Electronics product, such as safety design for hardware and software including but not limited to redundancy, fire control and malfunction prevention, appropriate treatment for aging degradation or any other appropriate measures. Because the evaluation of microcomputer software alone is very difficult, please evaluate the safety of the final products or systems manufactured by you.
8. Please contact a Renesas Electronics sales office for details as to environmental matters such as the environmental compatibility of each Renesas Electronics product. Please use Renesas Electronics products in compliance with all applicable laws and regulations that regulate the inclusion or use of controlled substances, including without limitation, the EU RoHS Directive. Renesas Electronics assumes no liability for damages or losses occurring as a result of your noncompliance with applicable laws and regulations.
9. Renesas Electronics products and technology may not be used for or incorporated into any products or systems whose manufacture, use, or sale is prohibited under any applicable domestic or foreign laws or regulations. You should not use Renesas Electronics products or technology described in this document for any purpose relating to military applications or use by the military, including but not limited to the development of weapons of mass destruction. When exporting the Renesas Electronics products or technology described in this document, you should comply with the applicable export control laws and regulations and follow the procedures required by such laws and regulations.
10. It is the responsibility of the buyer or distributor of Renesas Electronics products, who distributes, disposes of, or otherwise places the product with a third party, to notify such third party in advance of the contents and conditions set forth in this document, Renesas Electronics assumes no responsibility for any losses incurred by you or third parties as a result of unauthorized use of Renesas Electronics products.
11. This document may not be reproduced or duplicated in any form, in whole or in part, without prior written consent of Renesas Electronics.
12. Please contact a Renesas Electronics sales office if you have any questions regarding the information contained in this document or Renesas Electronics products, or if you have any other inquiries.

(Note 1) "Renesas Electronics" as used in this document means Renesas Electronics Corporation and also includes its majority-owned subsidiaries.

(Note 2) "Renesas Electronics product(s)" means any product developed or manufactured by or for Renesas Electronics.



### SALES OFFICES

Renesas Electronics Corporation

<http://www.renesas.com>

Refer to "<http://www.renesas.com/>" for the latest and detailed information.

**Renesas Electronics America Inc.**  
2801 Scott Boulevard Santa Clara, CA 95050-2549, U.S.A.  
Tel: +1-408-588-6000, Fax: +1-408-588-6130

**Renesas Electronics Canada Limited**  
9251 Yonge Street, Suite 8309 Richmond Hill, Ontario Canada L4C 9T3  
Tel: +1-905-237-2004

**Renesas Electronics Europe Limited**  
Dukes Meadow, Millboard Road, Bourne End, Buckinghamshire, SL8 5FH, U.K  
Tel: +44-1628-585-100, Fax: +44-1628-585-900

**Renesas Electronics Europe GmbH**  
Arcadiastrasse 10, 40472 Düsseldorf, Germany  
Tel: +49-211-6503-0, Fax: +49-211-6503-1327

**Renesas Electronics (China) Co., Ltd.**  
Room 1709, Quantum Plaza, No.27 ZhichunLu Haidian District, Beijing 100191, P.R.China  
Tel: +86-10-8235-1155, Fax: +86-10-8235-7679

**Renesas Electronics (Shanghai) Co., Ltd.**  
Unit 301, Tower A, Central Towers, 555 Langao Road, Putuo District, Shanghai, P. R. China 200333  
Tel: +86-21-2226-0888, Fax: +86-21-2226-0899

**Renesas Electronics Hong Kong Limited**  
Unit 1601-1611, 16/F., Tower 2, Grand Century Place, 193 Prince Edward Road West, Mongkok, Kowloon, Hong Kong  
Tel: +852-2265-8688, Fax: +852-2886-9022

**Renesas Electronics Taiwan Co., Ltd.**  
13F, No. 363, Fu Shing North Road, Taipei 10543, Taiwan  
Tel: +886-2-8175-9600, Fax: +886-2-8175-9670

**Renesas Electronics Singapore Pte. Ltd.**  
80 Bendemeer Road, Unit #06-02 Hyflux Innovation Centre, Singapore 339949  
Tel: +65-6213-0200, Fax: +65-6213-0300

**Renesas Electronics Malaysia Sdn.Bhd.**  
Unit 1207, Block B, Menara Amcorp, Amcorp Trade Centre, No. 18, Jin Persiaran Barat, 46050 Petaling Jaya, Selangor Darul Ehsan, Malaysia  
Tel: +60-3-7955-9390, Fax: +60-3-7955-9510

**Renesas Electronics India Pvt. Ltd.**  
No.777C, 100 Feet Road, HAL II Stage, Indiranagar, Bangalore, India  
Tel: +91-80-67208700, Fax: +91-80-67208777

**Renesas Electronics Korea Co., Ltd.**  
12F., 234 Teheran-ro, Gangnam-Gu, Seoul, 135-080, Korea  
Tel: +82-2-558-3737, Fax: +82-2-558-5141