

## FEATURES

- Member of the Texas Instruments Widebus™ Family
- UBE™ (Universal Bus Exchanger) Allows Synchronous Data Exchange
- Operates From 1.65 V to 3.6 V
- Max  $t_{pd}$  of 5.1 ns at 3.3 V
- $\pm 24$ -mA Output Drive at 3.3 V
- Bus Hold on Data Inputs Eliminates the Need for External Pullup/Pulldown Resistors
- Latch-Up Performance Exceeds 250 mA Per JESD 17
- ESD Performance Tested Per JESD 22
  - 2000-V Human-Body Model (A114-A)
  - 200-V Machine Model (A115-A)

## DESCRIPTION/ORDERING INFORMATION

This 9-bit, 4-port universal bus exchanger is designed for 1.65-V to 3.6-V  $V_{CC}$  operation.

The SN74ALVCH16409 allows synchronous data exchange between four different buses. Data flow is controlled by the select (SEL0–SEL4) inputs. A data-flow state is stored on the rising edge of the clock (CLK) input if the select-enable (SELEN) input is low. Once a data-flow state has been established, data is stored in the flip-flop on the rising edge of CLK if SELEN is high.

The data-flow control logic is designed to allow glitch-free data transmission.

When preset ( $\overline{PRE}$ ) transitions high, the outputs are disabled immediately, without waiting for a clock pulse. To leave the high-impedance state, both  $\overline{PRE}$  and SELEN must be low, and a clock pulse must be applied.

To ensure the high-impedance state during power up or power down,  $\overline{PRE}$  should be tied to  $V_{CC}$  through a pullup resistor; the minimum value of the resistor is determined by the current-sinking capability of the driver.

Active bus-hold circuitry holds unused or undriven inputs at a valid logic state. Use of pullup or pulldown resistors with the bus-hold circuitry is not recommended.

DGG OR DL PACKAGE  
(TOP VIEW)

|                  |    |    |                    |
|------------------|----|----|--------------------|
| $\overline{PRE}$ | 1  | 56 | CLK                |
| SEL0             | 2  | 55 | $\overline{SELEN}$ |
| 1A1              | 3  | 54 | 1B1                |
| GND              | 4  | 53 | GND                |
| 1A2              | 5  | 52 | 1B2                |
| 1A3              | 6  | 51 | 1B3                |
| $V_{CC}$         | 7  | 50 | $V_{CC}$           |
| 1A4              | 8  | 49 | 1B4                |
| 1A5              | 9  | 48 | 1B5                |
| 1A6              | 10 | 47 | 1B6                |
| GND              | 11 | 46 | GND                |
| 1A7              | 12 | 45 | 1B7                |
| 1A8              | 13 | 44 | 1B8                |
| 1A9              | 14 | 43 | 1B9                |
| 2A1              | 15 | 42 | 2B1                |
| 2A2              | 16 | 41 | 2B2                |
| 2A3              | 17 | 40 | 2B3                |
| GND              | 18 | 39 | GND                |
| 2A4              | 19 | 38 | 2B4                |
| 2A5              | 20 | 37 | 2B5                |
| 2A6              | 21 | 36 | 2B6                |
| $V_{CC}$         | 22 | 35 | $V_{CC}$           |
| 2A7              | 23 | 34 | 2B7                |
| 2A8              | 24 | 33 | 2B8                |
| GND              | 25 | 32 | GND                |
| 2A9              | 26 | 31 | 2B9                |
| SEL1             | 27 | 30 | SEL4               |
| SEL2             | 28 | 29 | SEL3               |

## ORDERING INFORMATION

| $T_A$         | PACKAGE <sup>(1)</sup> |               | ORDERABLE PART NUMBER | TOP-SIDE MARKING |
|---------------|------------------------|---------------|-----------------------|------------------|
| -40°C to 85°C | SSOP - DL              | Tube          | SN74ALVCH16409DL      | ALVCH16409       |
|               |                        | Tape and reel | SN74ALVCH16409DLR     |                  |
|               | TSSOP - DGG            | Tape and reel | SN74ALVCH16409DGGR    | ALVCH16409       |

(1) Package drawings, standard packing quantities, thermal data, symbolization, and PCB design guidelines are available at [www.ti.com/sc/package](http://www.ti.com/sc/package).



Please be aware that an important notice concerning availability, standard warranty, and use in critical applications of Texas Instruments semiconductor products and disclaimers thereto appears at the end of this data sheet.

Widebus, UBE are trademarks of Texas Instruments.

**SN74ALVCH16409**  
**9-BIT, 4-PORT UNIVERSAL BUS EXCHANGER**  
**WITH 3-STATE OUTPUTS**

SCES022G—JULY 1995—REVISED OCTOBER 2004

**FUNCTION TABLES**

| INPUTS |           | OUTPUT<br>RECEIVE PORT        |
|--------|-----------|-------------------------------|
| CLK    | SEND PORT |                               |
| X      | X         | B <sub>0</sub> <sup>(1)</sup> |
| X      | L         | L                             |
| X      | H         | H                             |
| ↑      | L         | L                             |
| ↑      | H         | H                             |
| H      | X         | B <sub>0</sub> <sup>(1)</sup> |
| L      | X         | B <sub>0</sub> <sup>(1)</sup> |

(1) Output level before the indicated steady-state input conditions were established

**DATA-FLOW CONTROL**

| INPUTS |       |     |      |      |      |      |      | DATA FLOW             |
|--------|-------|-----|------|------|------|------|------|-----------------------|
| PRE    | SELEN | CLK | SEL0 | SEL1 | SEL2 | SEL3 | SEL4 |                       |
| H      | X     | X   | X    | X    | X    | X    | X    | All outputs disabled  |
| L      | H     | ↑   | X    | X    | X    | X    | X    | No change             |
| L      | L     | ↑   | 0    | 0    | 0    | 0    | 0    | None, all I/Os off    |
| L      | L     | ↑   | 0    | 0    | 0    | 0    | 1    | Not used              |
| L      | L     | ↑   | 0    | 0    | 0    | 1    | 0    | Not used              |
| L      | L     | ↑   | 0    | 0    | 0    | 1    | 1    | Not used              |
| L      | L     | ↑   | 0    | 0    | 1    | 0    | 0    | Not used              |
| L      | L     | ↑   | 0    | 0    | 1    | 0    | 1    | Not used              |
| L      | L     | ↑   | 0    | 0    | 1    | 1    | 0    | Not used              |
| L      | L     | ↑   | 0    | 0    | 1    | 1    | 1    | Not used              |
| L      | L     | ↑   | 0    | 1    | 0    | 0    | 0    | 2A to 1A and 1B to 2B |
| L      | L     | ↑   | 0    | 1    | 0    | 0    | 1    | 2A to 1A              |
| L      | L     | ↑   | 0    | 1    | 0    | 1    | 0    | 2B to 1B              |
| L      | L     | ↑   | 0    | 1    | 0    | 1    | 1    | 2A to 1A and 2B to 1B |
| L      | L     | ↑   | 0    | 1    | 1    | 0    | 0    | 1A to 2A and 1B to 2B |
| L      | L     | ↑   | 0    | 1    | 1    | 0    | 1    | 1A to 2A              |
| L      | L     | ↑   | 0    | 1    | 1    | 1    | 0    | 1B to 2B              |
| L      | L     | ↑   | 0    | 1    | 1    | 1    | 1    | 1A to 2A and 2B to 1B |
| L      | L     | ↑   | 1    | 0    | 0    | 0    | 0    | 1A to 1B and 2B to 2A |
| L      | L     | ↑   | 1    | 0    | 0    | 0    | 1    | 1A to 1B              |
| L      | L     | ↑   | 1    | 0    | 0    | 1    | 0    | 2A to 2B              |
| L      | L     | ↑   | 1    | 0    | 0    | 1    | 1    | 1A to 1B and 2A to 2B |
| L      | L     | ↑   | 1    | 0    | 1    | 0    | 0    | 1B to 1A and 2A to 2B |
| L      | L     | ↑   | 1    | 0    | 1    | 0    | 1    | 1B to 1A              |
| L      | L     | ↑   | 1    | 0    | 1    | 1    | 0    | 2B to 2A              |
| L      | L     | ↑   | 1    | 0    | 1    | 1    | 1    | 1B to 1A and 2B to 2A |
| L      | L     | ↑   | 1    | 1    | 0    | 0    | 0    | 2B to 1A and 2A to 1B |
| L      | L     | ↑   | 1    | 1    | 0    | 0    | 1    | 1B to 2A              |
| L      | L     | ↑   | 1    | 1    | 0    | 1    | 0    | 2B to 1A              |
| L      | L     | ↑   | 1    | 1    | 0    | 1    | 1    | 2B to 1A and 1B to 2A |
| L      | L     | ↑   | 1    | 1    | 1    | 0    | 0    | 1A to 2B and 1B to 2A |
| L      | L     | ↑   | 1    | 1    | 1    | 0    | 1    | 1A to 2B              |
| L      | L     | ↑   | 1    | 1    | 1    | 1    | 0    | 2A to 1B              |
| L      | L     | ↑   | 1    | 1    | 1    | 1    | 1    | 1A to 2B and 2A to 1B |

**LOGIC DIAGRAM (POSITIVE LOGIC)**

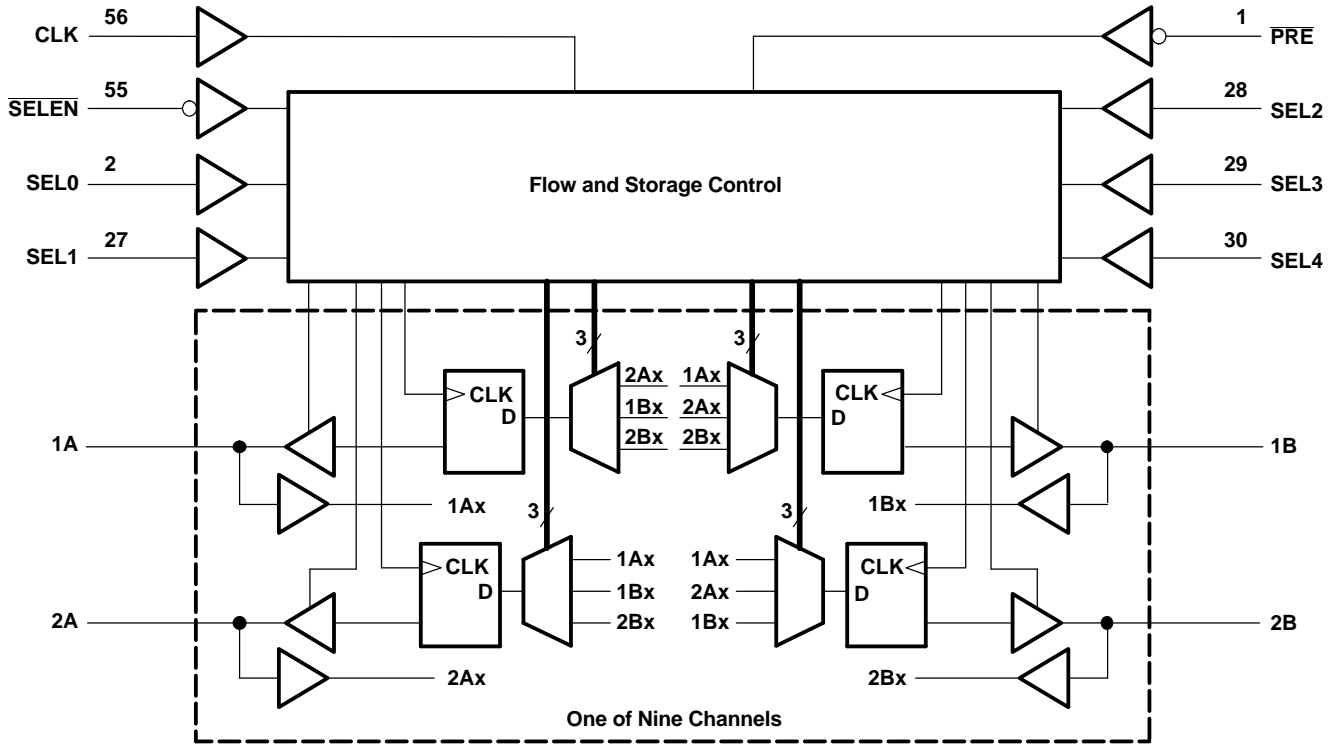

# SN74ALVCH16409

## 9-BIT, 4-PORT UNIVERSAL BUS EXCHANGER WITH 3-STATE OUTPUTS

SCES022G–JULY 1995–REVISED OCTOBER 2004

### ABSOLUTE MAXIMUM RATINGS<sup>(1)</sup>

over operating free-air temperature range (unless otherwise noted)

|                  |  | MIN                             | MAX                   | UNIT |
|------------------|--|---------------------------------|-----------------------|------|
| V <sub>CC</sub>  | Supply voltage range                                   | -0.5                            | 4.6                   | V    |
| V <sub>I</sub>   | Input voltage range                                    | Except I/O ports <sup>(2)</sup> |                       | V    |
|                  |  | I/O ports <sup>(2)(3)</sup>     |                       |      |
| V <sub>O</sub>   | Output voltage range <sup>(2)(3)</sup>                 | -0.5                            | V <sub>CC</sub> + 0.5 | V    |
| I <sub>IK</sub>  | Input clamp current                                    | V <sub>I</sub> < 0              |                       | -50  |
| I <sub>OK</sub>  | Output clamp current                                   | V <sub>O</sub> < 0              |                       | -50  |
| I <sub>O</sub>   | Continuous output current                              |                                 |                       | ±50  |
|                  | Continuous current through each V <sub>CC</sub> or GND |                                 |                       | ±100 |
| θ <sub>JA</sub>  | Package thermal impedance <sup>(4)</sup>               | DGG package                     |                       | 64   |
|                  |  | DL package                      |                       | 56   |
| T <sub>stg</sub> | Storage temperature range                              | -65                             | 150                   | °C   |

- (1) Stresses beyond those listed under "absolute maximum ratings" may cause permanent damage to the device. These are stress ratings only, and functional operation of the device at these or any other conditions beyond those indicated under "recommended operating conditions" is not implied. Exposure to absolute-maximum-rated conditions for extended periods may affect device reliability.
- (2) The input negative-voltage and output voltage ratings may be exceeded if the input and output current ratings are observed.
- (3) This value is limited to 4.6 V maximum.
- (4) The package thermal impedance is calculated in accordance with JESD 51-7.

### RECOMMENDED OPERATING CONDITIONS<sup>(1)</sup>

|                 |                                    | MIN                                | MAX             | UNIT |
|-----------------|------------------------------------|------------------------------------|-----------------|------|
| V <sub>CC</sub> | Supply voltage                     | 1.65                               | 3.6             | V    |
| V <sub>IH</sub> | High-level input voltage           | V <sub>CC</sub> = 1.65 V to 1.95 V |                 | V    |
|                 |                                    | V <sub>CC</sub> = 2.3 V to 2.7 V   |                 |      |
|                 |                                    | V <sub>CC</sub> = 2.7 V to 3.6 V   |                 |      |
| V <sub>IL</sub> | Low-level input voltage            | V <sub>CC</sub> = 1.65 V to 1.95 V |                 | V    |
|                 |                                    | V <sub>CC</sub> = 2.3 V to 2.7 V   |                 |      |
|                 |                                    | V <sub>CC</sub> = 2.7 V to 3.6 V   |                 |      |
| V <sub>I</sub>  | Input voltage                      | 0                                  | V <sub>CC</sub> | V    |
| V <sub>O</sub>  | Output voltage                     | 0                                  | V <sub>CC</sub> | V    |
| I <sub>OH</sub> | High-level output current          | V <sub>CC</sub> = 1.65 V           |                 | mA   |
|                 |                                    | V <sub>CC</sub> = 2.3 V            |                 |      |
|                 |                                    | V <sub>CC</sub> = 2.7 V            |                 |      |
|                 |                                    | V <sub>CC</sub> = 3 V              |                 |      |
| I <sub>OL</sub> | Low-level output current           | V <sub>CC</sub> = 1.65 V           |                 | mA   |
|                 |                                    | V <sub>CC</sub> = 2.3 V            |                 |      |
|                 |                                    | V <sub>CC</sub> = 2.7 V            |                 |      |
|                 |                                    | V <sub>CC</sub> = 3 V              |                 |      |
| Δt/Δv           | Input transition rise or fall rate |                                    | 10              | ns/V |
| T <sub>A</sub>  | Operating free-air temperature     | -40                                | 85              | °C   |

- (1) All unused control inputs of the device must be held at V<sub>CC</sub> or GND to ensure proper device operation. Refer to the TI application report, *Implications of Slow or Floating CMOS Inputs*, literature number SCBA004.

**ELECTRICAL CHARACTERISTICS**

over recommended operating free-air temperature range (unless otherwise noted)

| PARAMETER                      |                | TEST CONDITIONS  | V <sub>CC</sub>                            | MIN                   | TYP <sup>(1)</sup> | MAX  | UNIT |
|--------------------------------|----------------|--|--|-----------------------|--------------------|------|------|
| V <sub>OH</sub>                |                | I <sub>OH</sub> = -100 μA  | 1.65 V to 3.6 V                            | V <sub>CC</sub> - 0.2 |                    |      | V    |
|                                |                | I <sub>OH</sub> = -4 mA  | 1.65 V                                     | 1.2                   |                    |      |      |
|                                |                | I <sub>OH</sub> = -6 mA  | 2.3 V                                      | 2                     |                    |      |      |
|                                |                | I <sub>OH</sub> = -12 mA   | 2.3 V                                      | 1.7                   |                    |      |      |
|                                |                |  | 2.7 V                                      | 2.2                   |                    |      |      |
|                                |                |  | 3 V  | 2.4                   |                    |      |      |
| V <sub>OL</sub>                |                | I <sub>OL</sub> = 100 μA   | 1.65 V to 3.6 V                            |                       |                    | 0.2  | V    |
|                                |                | I <sub>OL</sub> = 4 mA   | 1.65 V                                     |                       |                    | 0.45 |      |
|                                |                | I <sub>OL</sub> = 6 mA   | 2.3 V                                      |                       |                    | 0.4  |      |
|                                |                | I <sub>OL</sub> = 12 mA  | 2.3 V                                      |                       |                    | 0.7  |      |
|                                |                |  | 2.7 V                                      |                       |                    | 0.4  |      |
|                                |                | I <sub>OL</sub> = 24 mA  | 3 V  |                       |                    | 0.55 |      |
| I <sub>I</sub>                 |                | V <sub>I</sub> = V <sub>CC</sub> or GND                                      | 3.6 V                                      |                       |                    | ±5   | μA   |
| I <sub>I(hold)</sub>           |                | V <sub>I</sub> = 0.58 V  | 1.65 V                                     | 25                    |                    |      | μA   |
|                                |                | V <sub>I</sub> = 1.07 V  | 1.65 V                                     | -25                   |                    |      |      |
|                                |                | V <sub>I</sub> = 0.7 V   | 2.3 V                                      | 45                    |                    |      |      |
|                                |                | V <sub>I</sub> = 1.7 V   | 2.3 V                                      | -45                   |                    |      |      |
|                                |                | V <sub>I</sub> = 0.8 V   | 3 V  | 75                    |                    |      |      |
|                                |                | V <sub>I</sub> = 2 V   | 3 V  | -75                   |                    |      |      |
|                                |                |  | V <sub>I</sub> = 0 to 3.6 V <sup>(2)</sup> | 3.6 V                 |                    |      |      |
| I <sub>OZ</sub> <sup>(3)</sup> |                | V <sub>O</sub> = V <sub>CC</sub> or GND                                      | 3.6 V                                      |                       |                    | ±10  | μA   |
| I <sub>CC</sub>                |                | V <sub>I</sub> = V <sub>CC</sub> or GND, I <sub>O</sub> = 0                  | 3.6 V                                      |                       |                    | 40   | μA   |
| ΔI <sub>CC</sub>               |                | One input at V <sub>CC</sub> - 0.6 V, Other inputs at V <sub>CC</sub> or GND | 3 V to 3.6 V                               |                       |                    | 750  | μA   |
| C <sub>i</sub>                 | Control inputs | V <sub>I</sub> = V <sub>CC</sub> or GND                                      | 3.3 V                                      |                       |                    | 4    | pF   |
| C <sub>io</sub>                | A or B ports   | V <sub>O</sub> = V <sub>CC</sub> or GND                                      | 3.3 V                                      |                       |                    | 8    | pF   |

 (1) All typical values are at V<sub>CC</sub> = 3.3 V, T<sub>A</sub> = 25°C.

(2) This is the bus-hold maximum dynamic current. It is the minimum overdrive current required to switch the input from one state to another.

 (3) For I/O ports, the parameter I<sub>OZ</sub> includes the input leakage current.

# SN74ALVCH16409

## 9-BIT, 4-PORT UNIVERSAL BUS EXCHANGER WITH 3-STATE OUTPUTS

SCES022G–JULY 1995–REVISED OCTOBER 2004

### TIMING REQUIREMENTS

over recommended operating free-air temperature range (unless otherwise noted) (see Figure 1)

|                    |                                 | $V_{CC} = 1.8\text{ V}$   |     | $V_{CC} = 2.5\text{ V} \pm 0.2\text{ V}$ |     | $V_{CC} = 2.7\text{ V}$ |     | $V_{CC} = 3.3\text{ V} \pm 0.3\text{ V}$ |     | UNIT |
|--------------------|---------------------------------|---|-----|--|-----|-------------------------|-----|--|-----|------|
|                    |                                 | MIN   | MAX | MIN                                      | MAX | MIN                     | MAX | MIN                                      | MAX |      |
| $f_{\text{clock}}$ | Clock frequency                 | (1)   |     | 120                                      |     | 120                     |     | 120                                      |     | MHz  |
| $t_w$              | Pulse duration, CLK high or low | (1)   |     | 4.2                                      |     | 4.2                     |     | 3  |     | ns   |
| $t_{\text{su}}$    | Setup time                      | A or B before CLK $\uparrow$                                      |     | (1)                                      |     | 1.9                     |     | 1.4                                      |     | ns   |
|                    |                                 | SEL before CLK $\uparrow$   |     | (1)                                      |     | 5.1                     |     | 4.2                                      |     |      |
|                    |                                 | $\overline{\text{SELE}}\overline{\text{N}}$ before CLK $\uparrow$ |     | (1)                                      |     | 2.5                     |     | 2.5                                      |     |      |
|                    |                                 | $\overline{\text{PRE}}$ before CLK $\uparrow$                     |     | (1)                                      |     | 1                       |     | 1  |     |      |
| $t_h$              | Hold time                       | A or B after CLK $\uparrow$                                       |     | (1)                                      |     | 0.8                     |     | 0.8                                      |     | ns   |
|                    |                                 | SEL after CLK $\uparrow$  |     | (1)                                      |     | 0                       |     | 0  |     |      |
|                    |                                 | $\overline{\text{SELE}}\overline{\text{N}}$ after CLK $\uparrow$  |     | (1)                                      |     | 0.5                     |     | 0.5                                      |     |      |

(1) This information was not available at the time of publication.

### SWITCHING CHARACTERISTICS

over recommended operating free-air temperature range (unless otherwise noted) (see Figure 1)

| PARAMETER        | FROM (INPUT)            | TO (OUTPUT) | $V_{CC} = 1.8\text{ V}$ |     | $V_{CC} = 2.5\text{ V} \pm 0.2\text{ V}$ |     | $V_{CC} = 2.7\text{ V}$ |     | $V_{CC} = 3.3\text{ V} \pm 0.3\text{ V}$ |     | UNIT |
|------------------|-------------------------|-------------|-------------------------|-----|--|-----|-------------------------|-----|--|-----|------|
|                  |                         |             | MIN                     | TYP | MIN                                      | MAX | MIN                     | MAX | MIN                                      | MAX |      |
| $f_{\text{max}}$ |                         |             | (1)                     |     | 120                                      |     | 120                     |     | 120                                      |     | MHz  |
| $t_{\text{pd}}$  | CLK                     | A or B      | (1)                     |     | 1.5                                      | 6   | 5.7                     |     | 1.5                                      | 5.1 | ns   |
| $t_{\text{en}}$  | CLK                     | A or B      | (1)                     |     | 2.4                                      | 6.9 | 6.3                     |     | 2  | 5.7 | ns   |
| $t_{\text{dis}}$ | CLK                     | A or B      | (1)                     |     | 2.3                                      | 7.1 | 6                       |     | 2  | 5.7 | ns   |
|                  | $\overline{\text{PRE}}$ |             | (1)                     |     | 2.8                                      | 7.5 | 6.5                     |     | 2.5                                      | 6.1 |      |

(1) This information was not available at the time of publication.

### OPERATING CHARACTERISTICS

$T_A = 25^\circ\text{C}$

| PARAMETER       |   | TEST CONDITIONS      | $V_{CC} = 1.8\text{ V}$ | $V_{CC} = 2.5\text{ V}$ | $V_{CC} = 3.3\text{ V}$ | UNIT |
|-----------------|---|----------------------|-------------------------|-------------------------|-------------------------|------|
|                 |   |                      | TYP                     | TYP                     | TYP                     |      |
| $C_{\text{pd}}$ | Power dissipation capacitance per exchanger | All outputs enabled  | (1)                     | 60                      | 60                      | pF   |
|                 |   | All outputs disabled | (1)                     | 60                      | 60                      |      |

(1) This information was not available at the time of publication.

**TIMING DIAGRAM**

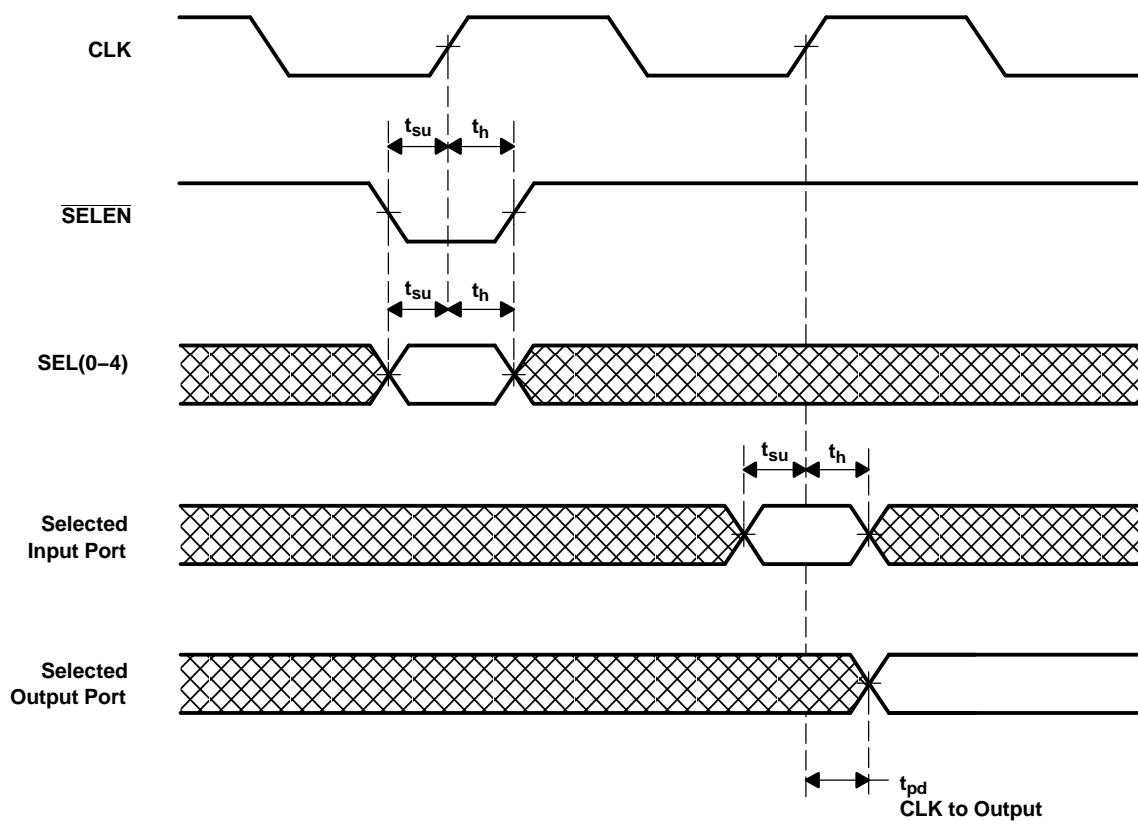

**PARAMETER MEASUREMENT INFORMATION**

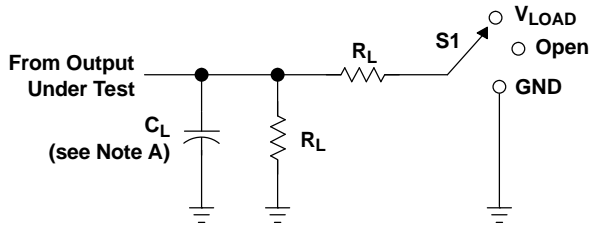

**LOAD CIRCUIT**

| TEST   | S1                        |
|--|---------------------------|
| $t_{pd}$<br>$t_{PLZ}/t_{PZL}$<br>$t_{PHZ}/t_{PZH}$ | Open<br>$V_{LOAD}$<br>GND |

| $V_{CC}$                         | INPUT    |                      | $V_M$      | $V_{LOAD}$        | $C_L$ | $R_L$        | $V_{\Delta}$ |
|----------------------------------|----------|----------------------|------------|-------------------|-------|--------------|--------------|
|                                  | $V_I$    | $t_r/t_f$            |            |                   |       |              |              |
| $1.8\text{ V} \pm 0.15\text{ V}$ | $V_{CC}$ | $\leq 2\text{ ns}$   | $V_{CC}/2$ | $2 \times V_{CC}$ | 30 pF | 1 k $\Omega$ | 0.15 V       |
| $2.5\text{ V} \pm 0.2\text{ V}$  | $V_{CC}$ | $\leq 2\text{ ns}$   | $V_{CC}/2$ | $2 \times V_{CC}$ | 30 pF | 500 $\Omega$ | 0.15 V       |
| 2.7 V                            | 2.7 V    | $\leq 2.5\text{ ns}$ | 1.5 V      | 6 V               | 50 pF | 500 $\Omega$ | 0.3 V        |
| $3.3\text{ V} \pm 0.3\text{ V}$  | 2.7 V    | $\leq 2.5\text{ ns}$ | 1.5 V      | 6 V               | 50 pF | 500 $\Omega$ | 0.3 V        |

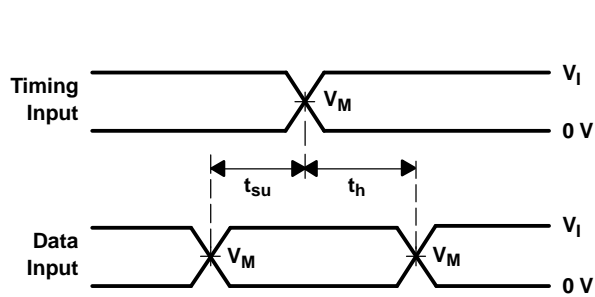

**VOLTAGE WAVEFORMS**  
**SETUP AND HOLD TIMES**

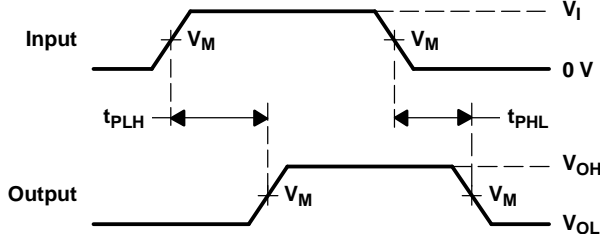

**VOLTAGE WAVEFORMS**  
**PROPAGATION DELAY TIMES**

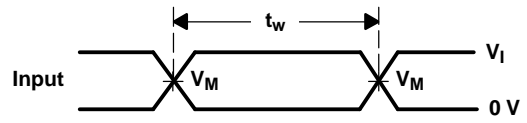

**VOLTAGE WAVEFORMS**  
**PULSE DURATION**

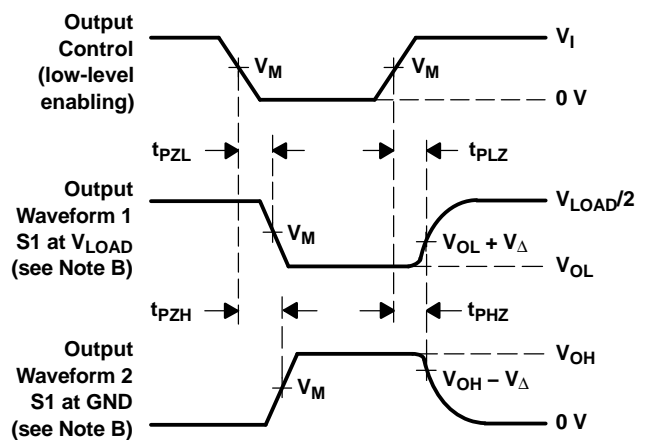

**VOLTAGE WAVEFORMS**  
**ENABLE AND DISABLE TIMES**

- NOTES: A.  $C_L$  includes probe and jig capacitance.  
B. Waveform 1 is for an output with internal conditions such that the output is low, except when disabled by the output control. Waveform 2 is for an output with internal conditions such that the output is high, except when disabled by the output control.  
C. All input pulses are supplied by generators having the following characteristics:  $PRR \leq 10\text{ MHz}$ ,  $Z_O = 50\ \Omega$ .  
D. The outputs are measured one at a time, with one transition per measurement.  
E.  $t_{PLZ}$  and  $t_{PHZ}$  are the same as  $t_{dis}$ .  
F.  $t_{PZL}$  and  $t_{PZH}$  are the same as  $t_{en}$ .  
G.  $t_{PLH}$  and  $t_{PHL}$  are the same as  $t_{pd}$ .  
H. All parameters and waveforms are not applicable to all devices.

**Figure 1. Load Circuit and Voltage Waveforms**



**PACKAGING INFORMATION**

| Orderable Device | Status<br>(1) | Package Type | Package Drawing | Pins | Package Qty | Eco Plan<br>(2) | Lead/Ball Finish<br>(6) | MSL Peak Temp<br>(3) | Op Temp (°C) | Device Marking<br>(4/5) | Samples |
|------------------|---------------|--------------|-----------------|------|-------------|-----------------|-------------------------|----------------------|--------------|-------------------------|---------|
| SN74ALVCH16409DL | ACTIVE        | SSOP         | DL              | 56   |             | TBD             | Call TI                 | Call TI              | -40 to 85    | ALVCH16409              | Samples |

(1) The marketing status values are defined as follows:

**ACTIVE:** Product device recommended for new designs.

**LIFEBUY:** TI has announced that the device will be discontinued, and a lifetime-buy period is in effect.

**NRND:** Not recommended for new designs. Device is in production to support existing customers, but TI does not recommend using this part in a new design.

**PREVIEW:** Device has been announced but is not in production. Samples may or may not be available.

**OBSOLETE:** TI has discontinued the production of the device.

(2) Eco Plan - The planned eco-friendly classification: Pb-Free (RoHS), Pb-Free (RoHS Exempt), or Green (RoHS & no Sb/Br) - please check <http://www.ti.com/productcontent> for the latest availability information and additional product content details.

**TBD:** The Pb-Free/Green conversion plan has not been defined.

**Pb-Free (RoHS):** TI's terms "Lead-Free" or "Pb-Free" mean semiconductor products that are compatible with the current RoHS requirements for all 6 substances, including the requirement that lead not exceed 0.1% by weight in homogeneous materials. Where designed to be soldered at high temperatures, TI Pb-Free products are suitable for use in specified lead-free processes.

**Pb-Free (RoHS Exempt):** This component has a RoHS exemption for either 1) lead-based flip-chip solder bumps used between the die and package, or 2) lead-based die adhesive used between the die and leadframe. The component is otherwise considered Pb-Free (RoHS compatible) as defined above.

**Green (RoHS & no Sb/Br):** TI defines "Green" to mean Pb-Free (RoHS compatible), and free of Bromine (Br) and Antimony (Sb) based flame retardants (Br or Sb do not exceed 0.1% by weight in homogeneous material)

(3) MSL, Peak Temp. - The Moisture Sensitivity Level rating according to the JEDEC industry standard classifications, and peak solder temperature.

(4) There may be additional marking, which relates to the logo, the lot trace code information, or the environmental category on the device.

(5) Multiple Device Markings will be inside parentheses. Only one Device Marking contained in parentheses and separated by a "~" will appear on a device. If a line is indented then it is a continuation of the previous line and the two combined represent the entire Device Marking for that device.

(6) Lead/Ball Finish - Orderable Devices may have multiple material finish options. Finish options are separated by a vertical ruled line. Lead/Ball Finish values may wrap to two lines if the finish value exceeds the maximum column width.

**Important Information and Disclaimer:** The information provided on this page represents TI's knowledge and belief as of the date that it is provided. TI bases its knowledge and belief on information provided by third parties, and makes no representation or warranty as to the accuracy of such information. Efforts are underway to better integrate information from third parties. TI has taken and continues to take reasonable steps to provide representative and accurate information but may not have conducted destructive testing or chemical analysis on incoming materials and chemicals. TI and TI suppliers consider certain information to be proprietary, and thus CAS numbers and other limited information may not be available for release.

In no event shall TI's liability arising out of such information exceed the total purchase price of the TI part(s) at issue in this document sold by TI to Customer on an annual basis.



## IMPORTANT NOTICE

Texas Instruments Incorporated and its subsidiaries (TI) reserve the right to make corrections, enhancements, improvements and other changes to its semiconductor products and services per JESD46, latest issue, and to discontinue any product or service per JESD48, latest issue. Buyers should obtain the latest relevant information before placing orders and should verify that such information is current and complete. All semiconductor products (also referred to herein as "components") are sold subject to TI's terms and conditions of sale supplied at the time of order acknowledgment.

TI warrants performance of its components to the specifications applicable at the time of sale, in accordance with the warranty in TI's terms and conditions of sale of semiconductor products. Testing and other quality control techniques are used to the extent TI deems necessary to support this warranty. Except where mandated by applicable law, testing of all parameters of each component is not necessarily performed.

TI assumes no liability for applications assistance or the design of Buyers' products. Buyers are responsible for their products and applications using TI components. To minimize the risks associated with Buyers' products and applications, Buyers should provide adequate design and operating safeguards.

TI does not warrant or represent that any license, either express or implied, is granted under any patent right, copyright, mask work right, or other intellectual property right relating to any combination, machine, or process in which TI components or services are used. Information published by TI regarding third-party products or services does not constitute a license to use such products or services or a warranty or endorsement thereof. Use of such information may require a license from a third party under the patents or other intellectual property of the third party, or a license from TI under the patents or other intellectual property of TI.

Reproduction of significant portions of TI information in TI data books or data sheets is permissible only if reproduction is without alteration and is accompanied by all associated warranties, conditions, limitations, and notices. TI is not responsible or liable for such altered documentation. Information of third parties may be subject to additional restrictions.

Resale of TI components or services with statements different from or beyond the parameters stated by TI for that component or service voids all express and any implied warranties for the associated TI component or service and is an unfair and deceptive business practice. TI is not responsible or liable for any such statements.

Buyer acknowledges and agrees that it is solely responsible for compliance with all legal, regulatory and safety-related requirements concerning its products, and any use of TI components in its applications, notwithstanding any applications-related information or support that may be provided by TI. Buyer represents and agrees that it has all the necessary expertise to create and implement safeguards which anticipate dangerous consequences of failures, monitor failures and their consequences, lessen the likelihood of failures that might cause harm and take appropriate remedial actions. Buyer will fully indemnify TI and its representatives against any damages arising out of the use of any TI components in safety-critical applications.

In some cases, TI components may be promoted specifically to facilitate safety-related applications. With such components, TI's goal is to help enable customers to design and create their own end-product solutions that meet applicable functional safety standards and requirements. Nonetheless, such components are subject to these terms.

No TI components are authorized for use in FDA Class III (or similar life-critical medical equipment) unless authorized officers of the parties have executed a special agreement specifically governing such use.

Only those TI components which TI has specifically designated as military grade or "enhanced plastic" are designed and intended for use in military/aerospace applications or environments. Buyer acknowledges and agrees that any military or aerospace use of TI components which have **not** been so designated is solely at the Buyer's risk, and that Buyer is solely responsible for compliance with all legal and regulatory requirements in connection with such use.

TI has specifically designated certain components as meeting ISO/TS16949 requirements, mainly for automotive use. In any case of use of non-designated products, TI will not be responsible for any failure to meet ISO/TS16949.

### Products

|                              |  |
|------------------------------|--|
| Audio                        | <a href="http://www.ti.com/audio">www.ti.com/audio</a>                               |
| Amplifiers                   | <a href="http://amplifier.ti.com">amplifier.ti.com</a>                               |
| Data Converters              | <a href="http://dataconverter.ti.com">dataconverter.ti.com</a>                       |
| DLP® Products                | <a href="http://www.dlp.com">www.dlp.com</a>   |
| DSP                          | <a href="http://dsp.ti.com">dsp.ti.com</a>   |
| Clocks and Timers            | <a href="http://www.ti.com/clocks">www.ti.com/clocks</a>                             |
| Interface                    | <a href="http://interface.ti.com">interface.ti.com</a>                               |
| Logic                        | <a href="http://logic.ti.com">logic.ti.com</a>                                       |
| Power Mgmt                   | <a href="http://power.ti.com">power.ti.com</a>                                       |
| Microcontrollers             | <a href="http://microcontroller.ti.com">microcontroller.ti.com</a>                   |
| RFID                         | <a href="http://www.ti-rfid.com">www.ti-rfid.com</a>                                 |
| OMAP Applications Processors | <a href="http://www.ti.com/omap">www.ti.com/omap</a>                                 |
| Wireless Connectivity        | <a href="http://www.ti.com/wirelessconnectivity">www.ti.com/wirelessconnectivity</a> |

### Applications

|                               |  |
|-------------------------------|--|
| Automotive and Transportation | <a href="http://www.ti.com/automotive">www.ti.com/automotive</a>                         |
| Communications and Telecom    | <a href="http://www.ti.com/communications">www.ti.com/communications</a>                 |
| Computers and Peripherals     | <a href="http://www.ti.com/computers">www.ti.com/computers</a>                           |
| Consumer Electronics          | <a href="http://www.ti.com/consumer-apps">www.ti.com/consumer-apps</a>                   |
| Energy and Lighting           | <a href="http://www.ti.com/energy">www.ti.com/energy</a>                                 |
| Industrial                    | <a href="http://www.ti.com/industrial">www.ti.com/industrial</a>                         |
| Medical                       | <a href="http://www.ti.com/medical">www.ti.com/medical</a>                               |
| Security                      | <a href="http://www.ti.com/security">www.ti.com/security</a>                             |
| Space, Avionics and Defense   | <a href="http://www.ti.com/space-avionics-defense">www.ti.com/space-avionics-defense</a> |
| Video and Imaging             | <a href="http://www.ti.com/video">www.ti.com/video</a>                                   |

### TI E2E Community

[e2e.ti.com](http://e2e.ti.com)