

LED Driver Series for LCD Backlight

White backlight LED Drivers

for medium to large LCD panels(Chopper type)



BD9202EFS

●Over View

BD9202EFS is the LED driver IC which loads the step-up DCDC controller and the constant electric current driver of 8ch. As for the constant electric current driver, PWM modulated light of 10bit gradation (1024stages) is possible with the register setting from 4 line serial interfaces. Because it can adjust brightness with every channel, back light is controlled in every area according to the light and shade of the picture, rise of contrast ratio is actualized.

●Feature

- 1)8ch constant electric current driver built-in
 - Largest drive electric current 150mA/CH *2
 - 10bit gradation (1024 stages) modulated light is possible by register setting
 - To input the standard CLK of PWM from outside is possible (BCT_SYNC_IN terminal)
 - Because it is high output resisting pressure (60V), the multi-stage connection of LED is possible
 - Detecting abnormal mode with LED opening detection
- 2)Step-up DCDC controller built-in
- 3) UVLO function
- 4) 4 line serial interface
- 5) HTSSOP-A44 Package

●Applications

For the equipment of loading LCD indicator of TV, monitor and note PC and the like

●Absolute maximum rating (Ta=25°C)

Parameter	Symbol	Rating	Unit
Power supply voltage	VCC	36	V
	CPUVDD	5.5	V
	VREG	5.5	V
LED1~8 terminal voltage	VLED1~8	60	V
EN,LOADSW terminal voltage	VEN,VLOADSW	36	V
FAIL1,FAIL2 terminal voltage	VFAIL1,VFAIL2	7	V
VREF,ISET,VSET,TEST,BRT,RT,CS,UVLO,COMP,CP1,CP2,TOUT1,TOUT2,SWOUT,OVP,CT_SYNC_IN,CT_SYNC_OUT,BCT_SYNC_IN,BCT_SYNC_OUT terminal voltage	VVREF, VISET, VVSET, VTEST, VBRT, VRT, VCS, VUVLO, VCOMP,VCP1,VCP2,VTOUT1,VTOUT2,VSWOUT,VOVPVCT_SYNC_IN,VCT_SYNC_OUT,VBCT_SYNC_IN,VBCT_SYNC_OUT	-0.3~5.5<VREG	V
CPUDI,CPUCLK,CPUCS,CPUDO terminal voltage	VCPUDI, VCPUCLK, VCPUCS, VCPUDO	-0.3~5.5<CPUVDD	V
Power Dissipation	Pd	4.5 *1	W
Operating Temperature Range	Topr	-40~+85	°C
Storage Temperature Range	Tstg	-55~+150	°C
LED Maximum Current	ILED	150 *2 *3	mA

*1At the time of mounting 2 layer glass epoxy base-plate of 70mm×70mm×1.6mm, 36.0mW is reduced at 1 °C above Ta=25.

*2 When the VF variation of LED is large, the loss quantity with the driver will increase, because there are times when package temperature rises, please do the base-plate design after considering heat dissipation measure sufficiently.

*3It is the electric current quantity per 1ch.

● Operating condition (Ta=25°C)

Parameter	Symbol	Voltage range	Unit
Power supply voltage	VREG	5.25~5.5	V
	CPUVDD	2.7~5.5	V
CT oscillation frequency setting range	fCT	300~800	kHz
CT_SYNC_IN input frequency range *4*5	FCT_SYNC_IN	fCT~800	kHz
BCT oscillation frequency setting range	fBCT	100~1000	kHz
BCT_SYNC_IN input frequency range *4*5	FBCT_SYNC_I	fBCT~1000	kHz
VSET Input potential	VSET	0.9~2.4	V

*4 When not using external frequency input, please connect the terminal of CT_SYNC_IN, BCT_SYNC_IN to GND.

*5 When using external frequency input, please do not do the operation that is changed to internal oscillation frequency on midway.

● Electric characteristic

((Unless otherwise specified Ta=25°C, VCC=24V, VREG=5V, CPUVDD=3V))

Parameter	Symbol	Limit			Unit	Condition
		Min	Typ	Max		
【All the circuit electric currents】						
Circuit electric currents	Icc	6	13	21	mA	VCC=24V CPUVDD=3V, EN=3V LED1~8=OFF
Stand-by electric current	IST	-	0	10	μA	EN=0V
【VREG section】						
VREG Output voltage	VREG	4.8	5	5.2	V	I _o =0mA, C _{REG} =2.2μF
VREG VREG sink electric current	I _{REG}	5	12	20	mA	At the time of external impressing of VREG=5.25Vat LED1~8=OFF, EN=3V
VREF Output voltage	VREF	1.57	1.60	1.63	V	I _o =0μA
【Switching section】						
SWOUT Source value of resistance	RONH	-	7	-	Ω	I _{ON} =-10mA
SWOUT Sink value of resistance	RONL	-	2	-	Ω	I _{ON} =10mA
【OCP section】						
Over-current protective operating voltage	VOLIMIT	0.1	0.2	0.3	V	V _{cs} =Sweep up
【Error amplifier section】						
LED Control voltage	VLED	0.55	0.75	0.95	V	
COMP Sink electric current	ICOMPSINK	40	100	200	μA	VLED=2V, V _{comp} =1V
COMP Source electric current	ICOMPSOURCE	-200	-100	-40	μA	VLED=0V, V _{comp} =1V
【CT Oscillator section】						
CT Oscillation frequency	FCT	500	600	700	kHz	RT=51kΩ
CT_SYNC_IN input High voltage	VSYNC_INH	VREG × 0.7	-	VREG +0.3	V	
CT_SYNC_IN input low voltage	VSYNC_INL	-0.3	-	VREG × 0.3	V	
CT_SYNC_OUT output high voltage	VSYNC_OUTH	VREG -1.0	VREG -0.15	-	V	I _{OL} =-1mA
CT_SYNC_OUT output low voltage	VSYNC_OUTL	-	0.1	0.5	V	I _{OL} =1mA
【BCT Oscillator section】						
BCT Oscillation frequency	FBCT	500	600	700	kHz	BRT=51kΩ
BCT_SYNC_IN input High voltage	VBSYNC_INH	VREG × 0.7	-	VREG +0.3	V	
BCT_SYNC_IN input low voltage	VBSYNC_INL	-0.3	-	VREG × 0.3	V	
BCT_SYNC_OUT output high voltage	VBSYNC_OUTH	VREG -1.0	VREG -0.15	-	V	I _{OL} =-1mA
BCT_SYNC_OUT output low voltage	VBSYNC_OUTL	-	0.1	0.5	V	I _{OL} =1mA
【OVP section】						
Over-voltage detection reference voltage	VOVP	1.85	2.0	2.15	V	VOVP=Sweep up
OVP Hysteresis voltage	VOVPHYS	0.4	0.5	0.6	V	VOVP=Sweep down
【UVLO section】						
UVLO (VREG) Detection voltage	VUVLO_VREG	2.6	2.9	3.2	V	VREG=Sweep down
UVLO (VREG) Hysteresis voltage	VUHYS_VREG	50	100	200	mV	VREG=Sweep up
UVLO(EXT) Detection voltage	VUVLO_EXT	1.7	1.9	2.1	V	UVLO=sweep down
UVLO(EXT) Hysteresis voltage	VUHYS_EXT	50	100	200	mV	UVLO=sweep up

● Pin configuration

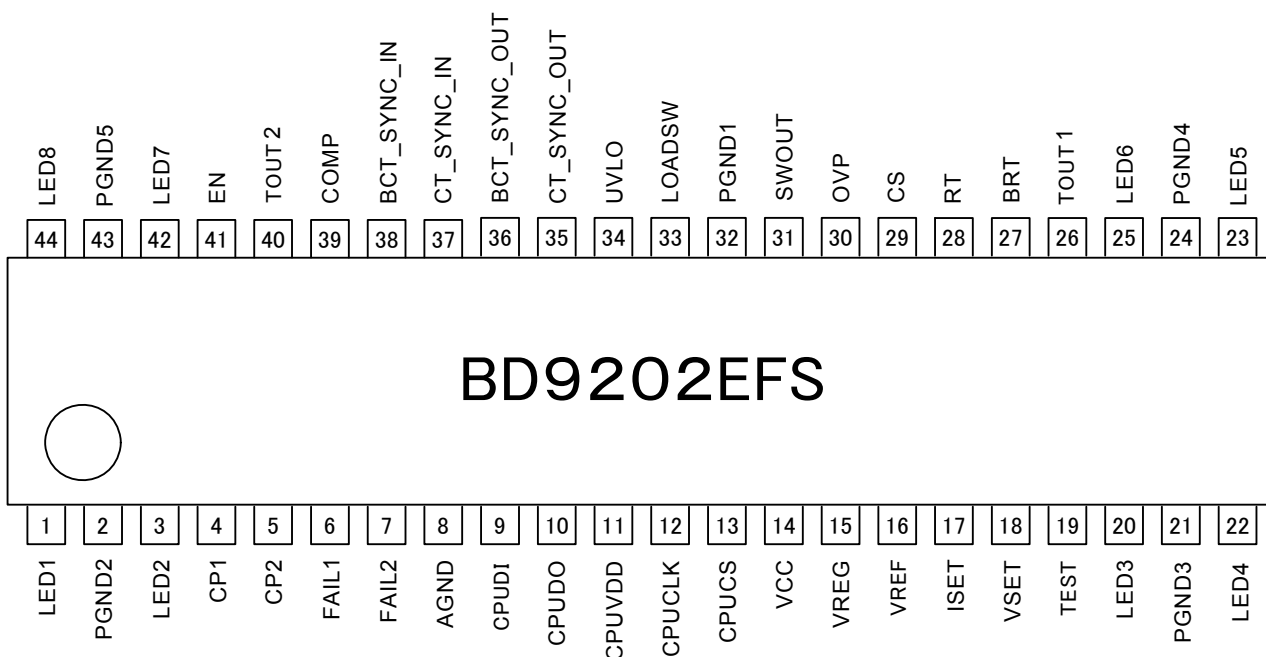

● Terminal number, terminal name

PIN No.	Terminal name	Function	PIN No.	Terminal name	Function
(1)	LED1	LED output terminal1	(23)	LED5	LED output terminal 5
(2)	PGND2	GND2 for LED	(24)	PGND4	GND4 for LED
(3)	LED2	LED output terminal2	(25)	LED6	LED output terminal 6
(4)	CP1	Condenser connected terminal for filter setting 1	(26)	TOUT1	Output terminal 1 for test monitor 1
(5)	CP2	Condenser connected terminal for filter setting 2	(27)	BRT	BCT oscillation frequency setting resistant connected terminal
(6)	FAIL1	Malfunction detection output 1	(28)	RT	CT oscillation frequency setting resistant connected terminal
(7)	FAIL2	Malfunction detection output 2	(29)	CS	DC/DC output electric current detection terminal
(8)	AGND	Small signal section GND	(30)	OVP	DC/DC Over-voltage detection terminal
(9)	CPUDI	Serial interface DATA input terminal	(31)	SWOUT	DC/DC Switching output terminal
(10)	CPUDO	Serial interface DATA output terminal	(32)	PGND1	GND1 for LED
(11)	CPUVDD	Serial interface Power supply terminal	(33)	LOADSW	Load switch control terminal
(12)	CPUCLK	Serial interface CLK input terminal	(34)	UVLO	It is the prevention detection terminal for miss operating at low voltage
(13)	CPUCS	Serial interface CS input terminal	(35)	CT_SYNC_OUT	CT Synchronization signal output terminal
(14)	VCC	Power supply terminal	(36)	BCT_SYNC_OUT	BCT Synchronization signal output terminal
(15)	VREG	Series regulator output terminal	(37)	CT_SYNC_IN	CT Synchronization signal input terminal
(16)	VREF	Reference voltage output terminal	(38)	BCT_SYNC_IN	BCT Synchronization signal input terminal
(17)	ISET	LED fixed electric current setting resistant connected terminal	(39)	COMP	Error amplifier output terminal
(18)	VSET	DC modulated light voltage input terminal	(40)	TOUT2	Output terminal 2 for test monitor
(19)	TEST	Test mode change terminal	(41)	EN	Enabling terminal
(20)	LED3	Output terminal 3	(42)	LED7	LED output terminal 7
(21)	PGND3	GND3 for LED	(43)	PGND5	GND5 for LED
(22)	LED4	LED output terminal 4	(44)	LED8	LED output terminal 8

● The reference data (Unless otherwise specified VCC=24V and Ta=25 °C)

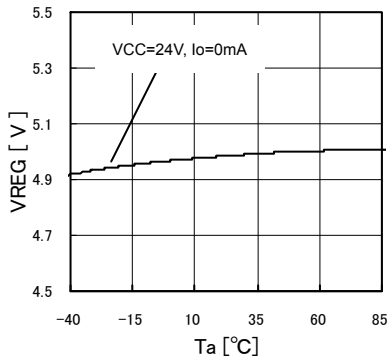

Fig.1 VREG Temperature characteristic

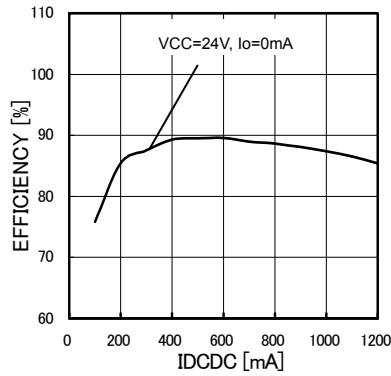

Fig.2 VREF Temperature characteristic

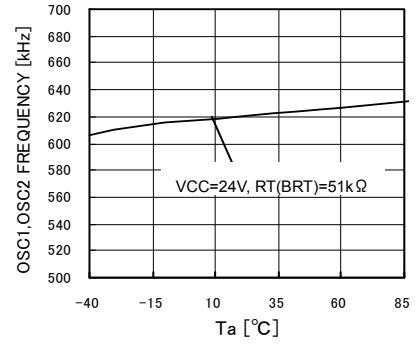

Fig.3 OSC1, OSC2 Temperature

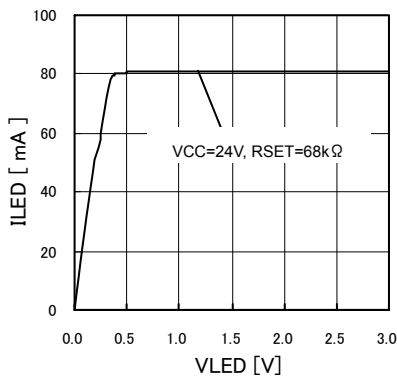

Fig.4 ILED depending on VLED

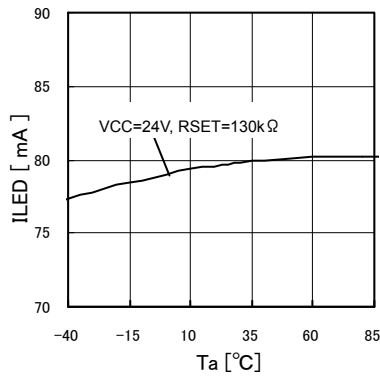

Fig.5 ILED Temperature characteristic

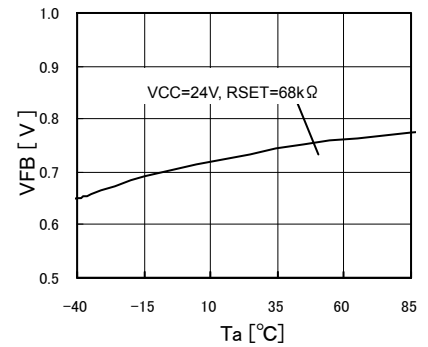

Fig.6 VSET Constant electric current characteristic

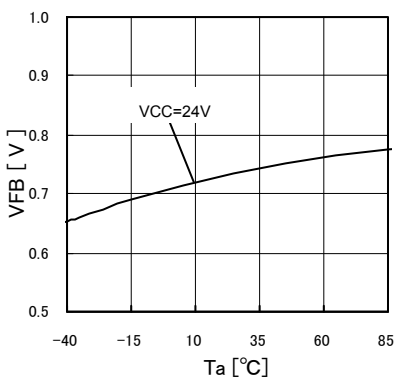

Fig.7 VLED Temperature characteristic

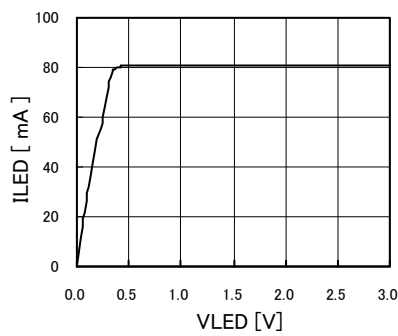

Fig.8 ICC-VCC characteristic

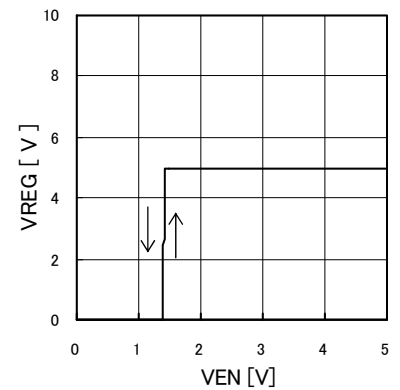

Fig.9 EN Threshold voltage

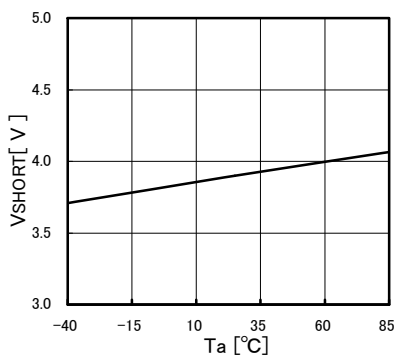

Fig.10 Short detection temperature characteristic

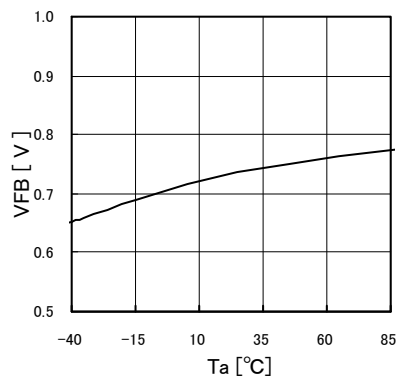

Fig.11 Open detection temperature characteristic

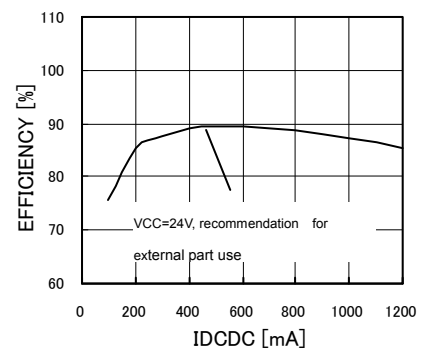

Fig.12 Efficiency

●Functional explanation

○ VREG

The fixed voltage of 5V is generated from VCC. It starts when it becomes EN=H.

UVLO (Under Voltage LOCK Out) is built in by VREG, When it is below 2.9V (typ), the internal circuit stops.

When it is above 3.0V (typ), the internal circuit operation starts.

Please connect $C_{reg}=2.2 \mu F$ to the VREG terminal, as a capacity for phase compensation.

In order to make IC heat generation decrease, impressing voltage into the VREG terminal from outside, it is possible to decrease the loss with the regulator inside IC.

In this case, as for the impressing voltage, please impress that of above output voltage (5.25V-5.5V) of the internal regulator.

○ UVLO (Under Voltage Lock Out)

There are UVLO (REG) which detects VREG voltage① and UVLO (VCC) ② which detects VCC voltage in UVLO.

When each UVLO is below specified value, the internal circuit is made to stop. (The logic section is reset.)

Detecting circuit	Detection object	Detection	Cancellation
UVLO (VREG)	VREG	Below 2.9V(typ)	Above 3.0V(typ)
UVLO (VCC)	VCC partial pressure input	Below 1.9V(typ)	Above 2.0V(typ)

Please do not connect VCC terminal (> 5.25V) to the UVLO terminal (for VCC detection) directly. Because there is a possibility of destruction, please be sure to input with partial pressure.

○ Fixed electric current driver

Fixed current value of the fixed electric current driver can be got by constant doubling the standard electric current which is decided by the resistance (RSET) of being connected to ISET and the voltage which are input into the VSET terminal. In addition continual electric current variable (analog modulated light) is possible by changing VSET voltage from outside.

In addition, it is possible to do PWM modulated light by the fact that the data is input to the internal register from the serial interface section. It is possible to set the Duty value of PWM for each channel.

- Setting of fixed current value

Fixed current value (DC value) of the LED driver is a relational expression below.

$$I_{LED} = \{ V_{SET} / (R_{SET}[k\Omega] + 20[k\Omega]) \} \times 7980 - 8 [mA]$$

However, when VSET voltage is above 2V, it reaches the point where it is clamped with 2V inside IC, fixed current value above that does not increase.

In addition, please input VSET in the range of 0.6V-2.4V.

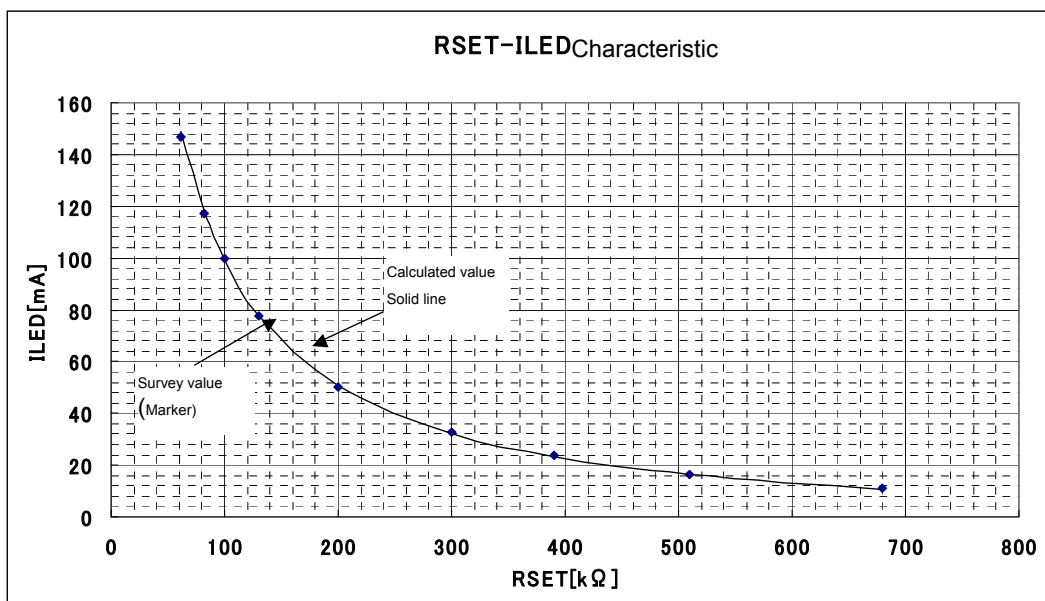

- VREF normal output

In VREG block, VREF (1.6V (typ.)) of reference voltage output is provided.

The necessity of doing the voltage impression from outside by the fact that this terminal is connected to the VSET terminal is gone.

However, because the voltage variation of VREF is to be reflected on the variation of LED fixed electric current directly, so that please pay attention to it.

○ Serial interface section

This IC is controlled by 4 line serial interfaces of CPUCLK, CPUCS, CPUDI and CPUDO. The data entry format and timing are shown below.

In the case of WRITE

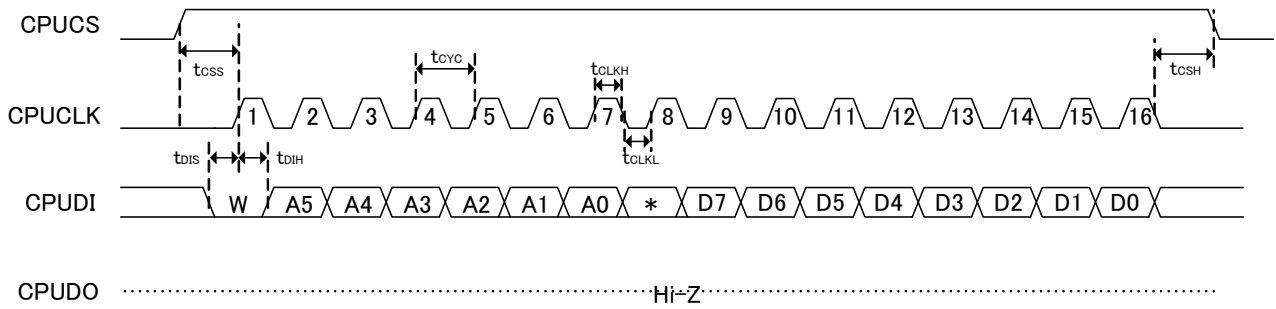

In the case of READ

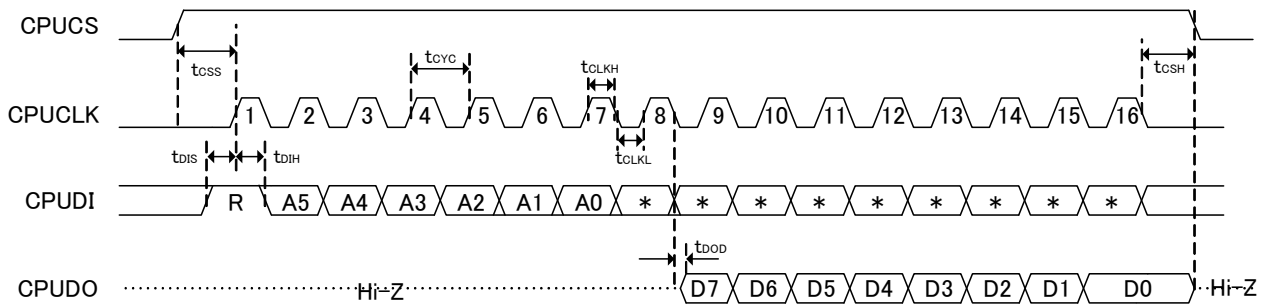

- It does not correspond to the continual entry of the data. It is necessary to set CPUCS into L in every address.
- There is no function of the automatic increment of address.
- Address width is correspondence to 6bit, but please do not access the address other than 00h-11h absolutely.

AC electric quality

Function	Symbol	Limit			Unit
		Min	Typ	Max	
CPUCLK Periods	t_{CYC}	100	-	-	ns
CPUCLK high level width	t_{CLKH}	35	-	-	ns
CPUCLK low level width	t_{CLKL}	35	-	-	ns
CPUDI input set up time	t_{DIS}	50	-	-	ns
CPUDI input hold time	t_{DIH}	50	-	-	ns
CPUCS input set up time	t_{CSS}	50	-	-	ns
CPUCS input hold time	t_{CSH}	50	-	-	ns
CPUDO Output delay time	t_{DOD}	-	-	40	ns

(Output load : 15pF)

Register map

Address	R/W	Initial value	Register name	Bit7	Bit6	Bit5	Bit4	Bit3	Bit2	Bit1	Bit0	Function
00H	R/W	00h	PWMCNT	PWMRST	-	-	-	-	-	PARADRV	PWMEN	PWM control register
01H	R/W	00h	LEDEN	LED8EN	LED7EN	LED6EN	LED5EN	LED4EN	LED3EN	LED2EN	LED1EN	LED ON/OFF Control register
02H	R/W	00h	SETPWM1	PWM LED1[7]	PWM LED1[6]	PWM LED1[5]	PWM LED1[4]	PWM LED1[3]	PWM LED1[2]	PWM LED1[1]	PWM LED1[0]	Register 1 for setting LED1 PWM (Subordinate bit setting)
03H	R/W	00h	SETPWM12	-	-	-	-	-	-	PWM LED1[9]	PWM LED1[8]	Register 2 for setting LED1 PWM (Superior bit setting)
04H	R/W	00h	SETPWM21	PWM LED2[7]	PWM LED2[6]	PWM LED2[5]	PWM LED2[4]	PWM LED2[3]	PWM LED2[2]	PWM LED2[1]	PWM LED2[0]	Register 1 for setting LED2 PWM (Subordinate bit setting)
05H	R/W	00h	SETPWM22	-	-	-	-	-	-	PWM LED2[9]	PWM LED2[8]	Register 2 for setting LED2 PWM (Superior bit setting)
06H	R/W	00h	SETPWM31	PWM LED3[7]	PWM LED3[6]	PWM LED3[5]	PWM LED3[4]	PWM LED3[3]	PWM LED3[2]	PWM LED3[1]	PWM LED3[0]	Register 1 for setting LED3 PWM (Subordinate bit setting)
07H	R/W	00h	SETPWM32	-	-	-	-	-	-	PWM LED3[9]	PWM LED3[8]	Register 2 for setting LED3 PWM (Superior bit setting)
08H	R/W	00h	SETPWM41	PWM LED4[7]	PWM LED4[6]	PWM LED4[5]	PWM LED4[4]	PWM LED4[3]	PWM LED4[2]	PWM LED4[1]	PWM LED4[0]	Register 1 for setting LED4 PWM (Subordinate bit setting)
09H	R/W	00h	SETPWM42	-	-	-	-	-	-	PWM LED4[9]	PWM LED4[8]	Register 2 for setting LED4 PWM (Superior bit setting)
0AH	R/W	00h	SETPWM51	PWM LED5[7]	PWM LED5[6]	PWM LED5[5]	PWM LED5[4]	PWM LED5[3]	PWM LED5[2]	PWM LED5[1]	PWM LED5[0]	Register 1 for setting LED5 PWM (Subordinate bit setting)
0BH	R/W	00h	SETPWM52	-	-	-	-	-	-	PWM LED5[9]	PWM LED5[8]	Register 2 for setting LED5 PWM (Superior bit setting)
0CH	R/W	00h	SETPWM61	PWM LED6[7]	PWM LED6[6]	PWM LED6[5]	PWM LED6[4]	PWM LED6[3]	PWM LED6[2]	PWM LED6[1]	PWM LED6[0]	Register 1 for setting LED6 PWM (Subordinate bit setting)
0DH	R/W	00h	SETPWM62	-	-	-	-	-	-	PWM LED6[9]	PWM LED6[8]	Register 2 for setting LED6 PWM (Superior bit setting)
0EH	R/W	00h	SETPWM71	PWM LED7[7]	PWM LED7[6]	PWM LED7[5]	PWM LED7[4]	PWM LED7[3]	PWM LED7[2]	PWM LED7[1]	PWM LED7[0]	Register 1 for setting LED7 PWM (Subordinate bit setting)
0FH	R/W	00h	SETPWM72	-	-	-	-	-	-	PWM LED7[9]	PWM LED7[8]	Register 2 for setting LED7 PWM (Superior bit setting)
10H	R/W	00h	SETPWM81	PWM LED8[7]	PWM LED8[6]	PWM LED8[5]	PWM LED8[4]	PWM LED8[3]	PWM LED8[2]	PWM LED8[1]	PWM LED8[0]	Register 1 for setting LED8 PWM (Subordinate bit setting)
11H	R/W	00h	SETPWM82	-	-	-	-	-	-	PWM LED8[9]	PWM LED8[8]	Register 2 for setting LED8 PWM (Superior bit setting)

All registers are reset by each condition below.

- UVLO(VREG)<2.9V(typ.)
- UVLO(EXT)<1.9V(typ.)
- Thermal shutdown detection (Tj>175°C)
- Register PWMRST=1(exclude PWMRST itself)

●ADDR=00h

PWMCNT(PWM Control register : Read/Write)

Bit	7	6	5	4	3	2	1	0
Register name	PWMRST	not used	not used	not used	not used	not used	PARADRV	PWMEN
Initial value	0	0	0	0	0	0	0	0

PWMEN	PWM mode control
0	disable (Default)
1	PWM mode enable

PARADRV	LED output control
0	To control LED1-LED8 independently
1	To control LED1 and 2, LED3 and 4, LED5 and 6, LED7 and 8 simultaneously

PWMRST	PWM logic reset control
0	Normal Function (Default)
1	Logic reset

When it makes PWMRST = ' 1 ', PWM Logic and all registers (the PWMRST register is excluded) is reset.

To make normal operation, it is necessary to reset if make PWMRST= ' 0 '.

When it makes PARADRV= ' 1 ', because LED1 and LED2 (LED3 and LED4, LED5 and LED6, LED7 and LED8) operate synchronously (following the setting of LED of odd number turn), when you use the output of LED1 and LED2 (LED3 and LED4, LED5 and LED6, LED7 and LED8) by short-circuiting, it operates as each heavy-current driver of ILEDMAX=300mA.

●ADDR=01h

LEDEN(LED ON/OFF Control register : Read/Write)

Bit	7	6	5	4	3	2	1	0
Register name	LED8EN	LED7EN	LED6EN	LED5EN	LED4EN	LED3EN	LED2EN	LED1EN
Initial value	0	0	0	0	0	0	0	0

LED1(~8)EN	LED1 (~8) output control
0	OFF (Default)
1	Usual ON

When doing PWM modulated light with PWMEN of ADDR=00h, if LED1 of ADDR=01h (8) EN is designated as 1, it becomes regular ON. (LED1 (8) EN takes precedence.) So after that, if LED1 (8) EN is designated as 0, it returns to the PWM modulated light that is set at beginning.

●ADDR=02h

SETPWM11(Register 1 for setting LED1 PWM (Subordinate bit setting) : Read/Write)

Bit	7	6	5	4	3	2	1	0
Register name	PWMLED1[7]	PWMLED1[6]	PWMLED1[5]	PWMLED1[4]	PWMLED1[3]	PWMLED1[2]	PWMLED1[1]	PWMLED1[0]
Initial value	0	0	0	0	0	0	0	0

●ADDR=03h

SETPWM12((Register 2 for setting LED1 PWM (superior bit setting) : Read/Write)

Bit	7	6	5	4	3	2	1	0
Register name	not used	not used	not used	not used	not used	not used	PWMLED1[9]	PWMLED1[8]
Initial value	0	0	0	0	0	0	0	0

It sets Duty of PWM modulated light with the total 10bit of Bit7-0 of ADDR=02h and Bit1-0 of ADDR=03h. To set the subordinate position 8bit with ADDR=02h and the Superior position 2bit with ADDR=03h. (Chart below)

PWMLED1[9:0]	LED1 Pulse width
"000000000"	Usual 'L' (Default)
"000000001"	PWMCLK 1 Clock width
"000000010"	PWMCLK 2 Clock width
"000000011"	PWMCLK 3 Clock width
~	~
"111111100"	PWMCLK 1020 Clock width
"111111101"	PWMCLK 1021 Clock width
"111111110"	PWMCLK 1022 Clock width
"111111111"	PWMCLK 1023 Clock width

●ADDR=04h~11h

The setting method is similar to LED1 of ADDR=02h,03h is described above with the PWM pulse width setting register of LED28.

PWM Setting example

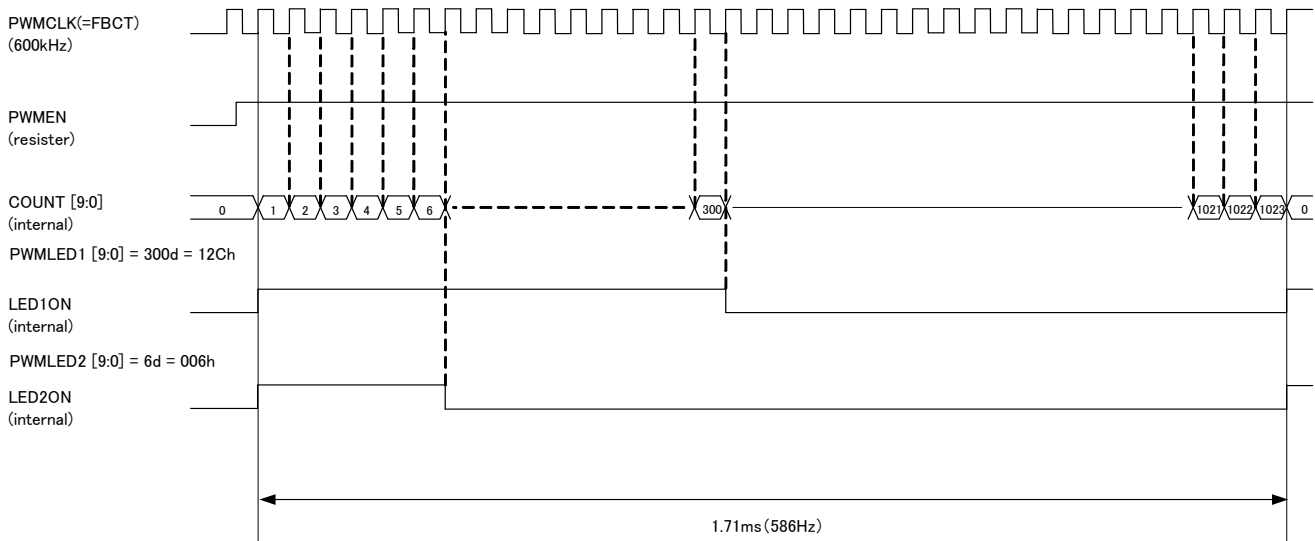

- ※ When count [9:0] becomes 1, LEDON will become High and then LED lights up. When COUNT [9:0] reaches to the value that is set by PWM pulse, LEDON will become Low and the light goes out.
- ※ COUNT [9:0] = 1 with Illumination timing of each channel becomes being identical.
- ※ When setting of pwm modulated light is modified, it is reflected being at the point where COUNT [9:0] is reset to 0 (It is not immediately reflection with register entry)
- ※ After writing ' 1 ' in PWMEN, the delay of 0 ~ maximum of 1 clocks occurs until LED lights up.

○ Register setting example of LED illuminations

- When illuminates LED3 and LED8 regular (100% illumination)
 - ① (ADDR,DATA)=(01h, 84h) → Operation of regular illumination
- When it does PWM modulated light with 40% to LED3, and 80% to LED8,
 - $1024 \times 40\% = 409$, $1024 \times 80\% = 819$
 - Because (409)DEC=(199)HEX, (819)DEC=(333)HEX
 - ① (ADDR,DATA)=(06h, 99h) → Setting LED3 to 40%
 - (ADDR,DATA)=(07h, 01h) → Setting LED8 to 80%
 - ② (ADDR,DATA)=(10h, 33h) → Setting LED8 to 80%
 - (ADDR,DATA)=(11h, 03h) → Setting LED3 to 40%
 - ③ (ADDR,DATA)=(00h, 01h) → Operation of modulated light

○ The method connected control wire when plural IC is used

Connected method of the control wire when plural BD9202EFS is controlled with one CPU is shown.

You connect CPUCLK and CPUDI in parallel (note the ability of respective drive), CPUCS wires in each BD9202EFS.

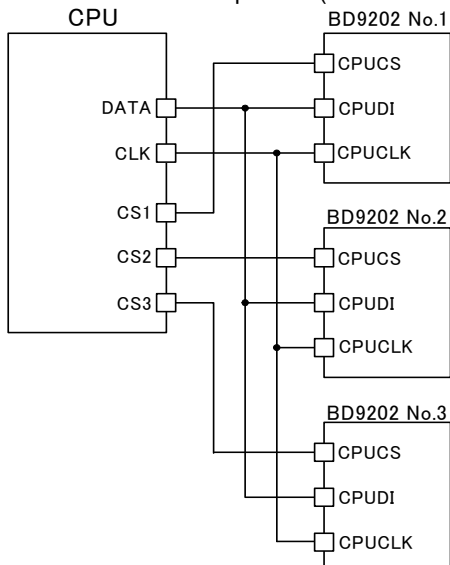

○Booster DC/DC Controller

- LED Series Numeric

It detects the LED cathode voltage, or the LED voltage, and controls the output voltage to be 0.75 (Typ.). The booster only operates when the LED output is operating. When multiple LED outputs are operating, the LED VF controls the LED output of the highest line to be 0.75V (Typ.). Therefore, the voltages of other LED outputs are higher by the variation of VF.

Furthermore, you must be aware that the LED inline numerics have the following limits. At open detection, 85% of the OVP configured voltage becomes the trigger, so the maximum value of output voltage during normal operation is $51V=60 \times 0.85$, and $51V/VF > \text{maximum N}$.

- Over voltage Protection Circuit OVP

Inputs the output voltage to the OVP terminal with resistive divide. The configured value of OVP should be determined by the series numeric of the LED and the VF variance. When determining the OVP configured voltage, the open detection trigger, $OVP \times 0.85$ should be considered. The switching operation stops when OVP is detected. Furthermore, if the output voltage falls to 80% of the OVP configuration voltage within the filter time $tcp1$ determined by CP1, OVP is released. If OVP continues for over $tcp1$, the error detection flag FAIL1 turns to Low, it latches with the switching operation in the stopped position.

When the output voltage side is ROVP1 and the GND side is ROVP2, the OVP detection voltage is:

$$VOVP = (ROVP1 + ROVP2) / ROVP2 \times 2.0V$$

When $ROVP1 = 560k\Omega$ and $ROVP2 = 20k\Omega$, OVP activates when $VOUT = 58V$ or more.

- Booster DC/DC Converter Oscillation Frequency and LED Driver PWM Standard Frequency

By attaching resistance to RT (BRT), it is possible to configure triangular wave oscillation frequency. The RT (BRT) determines the charge and discharge current corresponding to the internal condenser, and the frequency changes. Configure the RT (BRT) resistance by referring to the theoretical formula below. We recommend a range of $30k\Omega \sim 300k\Omega$. Configurations outside of the frequency range in the chart below can result in stopping switching, and operation cannot be guaranteed.

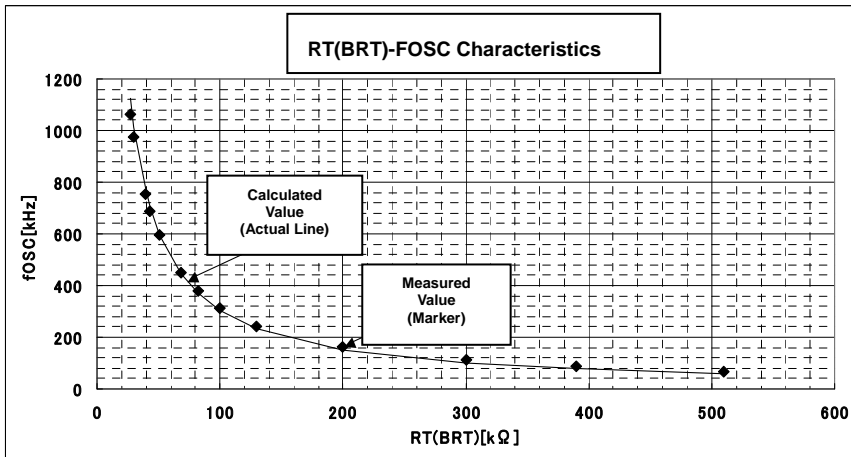

$$f_{osc} = \frac{3.04 \times 10^4}{RT(BRT)[k\Omega]} [kHz]$$

- Internal Oscillation Frequency Output Terminal CT_SYNC_OUT and External Synchronous Terminal CT_SYNC_IN
The internal oscillation frequency output terminal CT_SYNC_OUT outputs the internal oscillator's clock configured by the RT terminal. However, there is no output when there is a CLK input in the external synchronous terminal CT_SYNC_IN.

The external synchronous terminal CT_SYNC_IN can be the operational frequency of the DC/DC converter by externally inputting CLK. At this time, the external input frequency should be configured to be higher than the internal oscillation frequency. Furthermore, there should be no switching between the external synchronous and internal oscillator during operation.

- Soft Start

There is no soft start function with this IC. At startup, stand-up occurs with control by the current value configured by OCP (over-current detection).

- Over-current Protection Circuit (OCP)

The current flowing through the coil is changed to voltage by the sense resistance Rcs, and when the CS terminal is over 0.2V (typ), the switching operation is stopped.

OCP detection is in pulse-by-pulse format, and is detected at every switching cycle and reset at the next clock.

When detection continues longer than the time configured at $tcp1$, $FAIL1=L$ and it latches with the switching operation in the stopped position.

○ Error Detection Output Function

- Outputs errors detected by protection circuits to FAIL1 and FAIL2 terminals. FAIL1 or FAIL2 switch to Low after the filter time configured at CP1 or CP2, when they detect OVP or OCP (FAIL1) or LED open/short (FAIL2). (Because FAIL1 terminal is open collector output, it is used with external pull-up.)

The filter time for CP1 and CP2 is expressed as:

$$T_{cp1(cp2)} = \frac{C_{cp1} \times 2V}{1\mu A}$$

【Protection Functions】

Protection Function	Detection	Release	Type	Logic at detection	
				FAIL1	FAIL2
UVLO (VREG)	VREG < 2.9V	VREG > 3.0V	Hysteresis	H	H
UVLO (EXT)	UVLO < 1.9V	UVLO > 2.0V	Hysteresis	H	H
TSD	T _j > 175°C	T _j < 150°C	Hysteresis	H	H
OVP	VOVP > 2.0V & t > tCP1	VOVP < 1.5V	Latch	L	H
OCP	VCS ≥ 0.2V & t > tCP1	VCS < 0.2V	Latch	L	H
LED open detection	VLED < 0.2V & VOVP > 1.7V	VLED > 0.2V & VOVP < 1.6V	Latch	H	L
LED short detection	VLED ≥ 4.0V	VLED < 4.0V	Latch	H	L

To clear the latch type, the logic section must be reset.

Protection Function	Operation at protection function detection			
	DCDC	LOADSW	LED Dr	Internal logic
UVLO (VREG)	Stop	ON	All CH stop	Reset
UVLO (EXT)	Stop	ON	All CH stop	Reset
TSD	Stop	ON	All CH stop	Reset
OVP	Stop	OFF	(All CH stop) *2	Normal operation
OCP	Current limit	OFF	Normal operation	Normal operation
LED open detection *1	Stop	ON	All CH stop	Normal operation
LED short detection *1	Stop	ON	All CH stop	Normal operation

*1 LED open and short detection is only valid with operating channels, and all CH turn to OFF when 1-ch error is detected. Furthermore, it is only valid in the ON areas during PWM operation.

*2 Because the DC/DC converter stops and there is no voltage supply for the LED, the light will be turned off.

● Selection of External Parts

1. Selection of Coil (L)

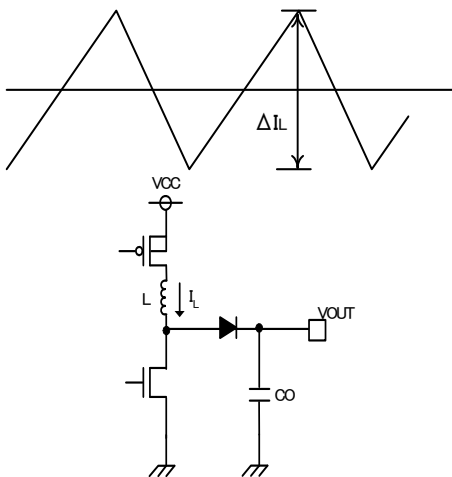

The value of the coil greatly affects the input ripple current. As presented in formula (1), the larger the coil and the higher the switching frequency, the lower the ripple current.

$$\Delta IL = \frac{(VOUT - Vcc) \times Vcc}{L \times VOUT \times f} [A] \quad \dots \dots (1)$$

When efficiency is expressed as in formula (2), the input peak current is as shown in formula (3).

$$\eta = \frac{VOUT \times IOU}{Vcc \times Icc} \quad \dots \dots (2)$$

$$ILMAX = Icc + \frac{\Delta IL}{2} = \frac{VOUT \times IOU}{Vcc \times \eta} + \frac{\Delta IL}{2} \quad \dots \dots (3)$$

- ※ If current that is stronger than the coil's fixed current value flows through the coil, there is magnetic saturation in the coil, lowering efficiency. A margin large enough should be considered during selection, so that the peak current does not exceed the coil's fixed current value.
- ※ To lessen loss from the coil and improve efficiency, coils with low resistance components (DCR and ACR) should be selected.

2. Selection of Output Condenser (Co)

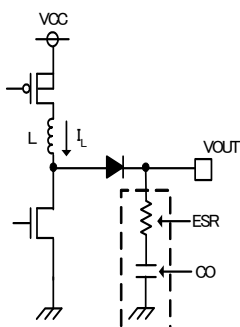

The stability domain of the output voltage and equivalent series resistance necessary to smooth out the ripple voltage should be considered when choosing a condenser for the output side.

The output ripple voltage is determined by formula (4).

$$\Delta VOUT = ILMAX \times RESR + \frac{l}{Co} \times \frac{IOU}{\eta} \times \frac{1}{f} [V] \quad \dots \dots (4)$$

(ΔIL: output ripple current, ESR: equivalent series resistance of Co, η: efficiency)

※The condenser's fixed value should be selected with enough margin for the output voltage.

3. Selection of Input Condenser (Cin)

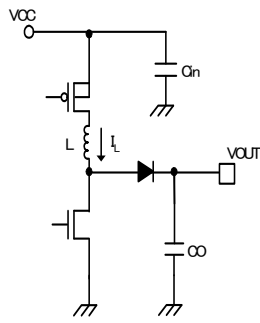

The input condenser selected should have low ESR with enough capacity to be compatible large ripple current, in order to prevent large transient voltage.

The ripple current IRMS can be derived from formula (5).

$$IRMS = I_{OUT} \times \frac{\sqrt{(V_{OUT} - V_{CC}) \times V_{OUT}}}{V_{OUT}} [A] \quad \dots \dots (5)$$

Furthermore, because it relies heavily on the characteristics of the power used for input, the wiring pattern on the substrate and MOSFET gate drain capacity, the usage temperature, load range and MOSFET conditions must be adequately confirmed.

4. Selection of MOSFET for Load Switch, and its Soft Start

Because there are no switches on the route between the VCC and the VO with regular boost applications, in case of an output short circuit the coil or rectification diode may be damaged. To prevent this from happening, a PMOSFET load switch should inserted between the VCC and the coil. PMOSFET with better ability to withstand pressure between gate-source and drain-source than VCC should be selected.

To initiate soft start of the load switch, insert capacity between the gate and source.

5. Selection of Switching MOSFET

There are no problems as long as the absolute maximum rating of the current rating is L and the pressure threshold and rectification diode of C are at least VF, but in order to actualize high-speed switching, one with small gate capacity (injected charge amount) should be selected.

- ※ Excess of over current protection configuration recommended
- ※ Higher efficiency can be gained if one with smaller ON resistance is selected.

6. Selection of Rectification Diode

Select a Schottky barrier diode with higher current ability than the current rating of L and higher reverse pressure threshold than the threshold of C, particularly with low forward voltage VF.

● Phase Compensation Configuration Method

• Stability of Applications

Feedback stability conditions for reverse feedback are as follows:

- Phase-lag of less than 150° (phase margin of over 30°) when gain is 1 (0dB)

Furthermore, DC/DC converter applications have been sampled by the switching frequency, so the GBW of the entire line is configured at less than 1/10 of the switching frequency. To sum up, the characteristics aimed for by applications are as outlined below:

- Phase-lag less than 150° (phase margin over 30°) when gain is 1 (0dB)
- The GBW (frequency of gain 0dB) at that time is less than 1/10 of switching frequency

Therefore, to improve the response with GBW limitations, it is necessary to make the switching frequency higher.

The trick to secure stability by phase compensation is to cancel out the second phase lag (-180°) generated by LC resonance with two phase leads (insert two phase leads).

Phase leads are by the output condenser's ESR component or the error amp output Comp terminal's CR.

With DC/DC converter applications, there is always a LC resonance circuit at the output, so the phase lag at that section is 180° . If the output condenser has large ESR (several Ω), such as an aluminum electrolysis condenser, a phase lead of +90° is generated, and the phase lag is -90° . When using an output condenser with low ESR such as a ceramic condenser, insert R for the ESR component.

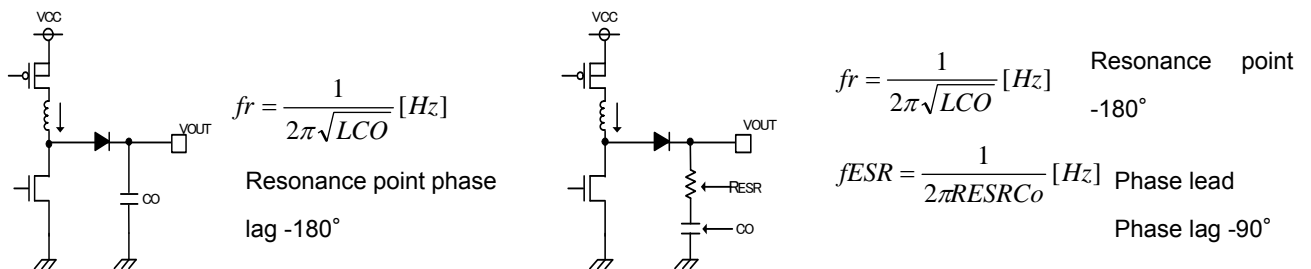

With the changes in phase characteristics by caused by ESR, the number of phase leads to be inserted is one.

The frequency configuration to insert phase lead should ideally be configured close to the LC resonance frequency in order to cancel LC resonance.

This configuration is for simplicity, and no detailed calculations have been carried out, so there are times when adjustments on the actual product are necessary. These characteristics change depending on substrate layout and load conditions, so ample confirmation is necessary during design for mass production.

● External Parts for PCB Board

Name	Type	Parts Number	Connecting Point	Size	Maker	Pieces/Board
Connector	For SPI/IF	22 05 2081	-	-	Molex	2
	For LED Board I/F	22 05 2121	-	-	Molex	1
	For Power Supply	22 01 2045	-	-	Molex	1
Ceramic	-	-	CSS	1005	murata	1
	27pF	GRM1882C1H270JA01	CP1 , CP2	1608	murata	2
	1000pF	GRM15XB11H102KA86	CLPF	1005	murata	1
	10uF	GRM55D31106KA87	CVCC	5750	murata	1
	2.2uF	GRM188R71A225KE15	CREG	1608	murata	1
	1uF	GRM188R71A105KA61	CPC	1608	murata	1
Tantal	220uF	UVR5A221MPD	CVOUT	-	Rubicon	1
	Resistance	5.1kΩ	MCR03Series5101	RLD1 , RLD2 , RFL1 , RFL2	1608	ROHM
-		-	RESR	3216	-	1
51mΩ		MCR10SeriesR051	RCS	2012	ROHM	1
100Ω		MCR03Series1000	RLPF	1608	ROHM	1
300Ω		MCR03Series3000	RPC , RVCC	1608	ROHM	1
10kΩ		MCR03Series1002	RUVLO2	1608	ROHM	1
20kΩ		MCR03Series2002	ROVP2	1608	ROHM	1
51kΩ		MCR03Series5102	RCT , RBCT	1608	ROHM	2
68kΩ		MCR03Series6802	RSET	1608	ROHM	1
91kΩ		MCR03Series9102	RUVLO1	1608	ROHM	1
560kΩ		MCR03Series5603	ROVP1	1608	ROHM	1
PMOS	-	RSS090P03FU6TB	Q1	-	ROHM	1
NMOS	-	TCP8213-H	Q2	-	TOSHIBA	1
Inductance	47uH	C12-K7.5L EJ	L1	-	Mitsumi	1
Diode	-	RB160L-60TE25	D1	-	ROHM	1

※ The values above are fixed, and have been verified for operation at VCC=24V, LED12-series 8-parallel and ILED=150mA.
Therefore, the optimal values can vary depending on usage conditions, so fixed values should be determined with careful consideration.

● In/Output Equivalent Circuit 1

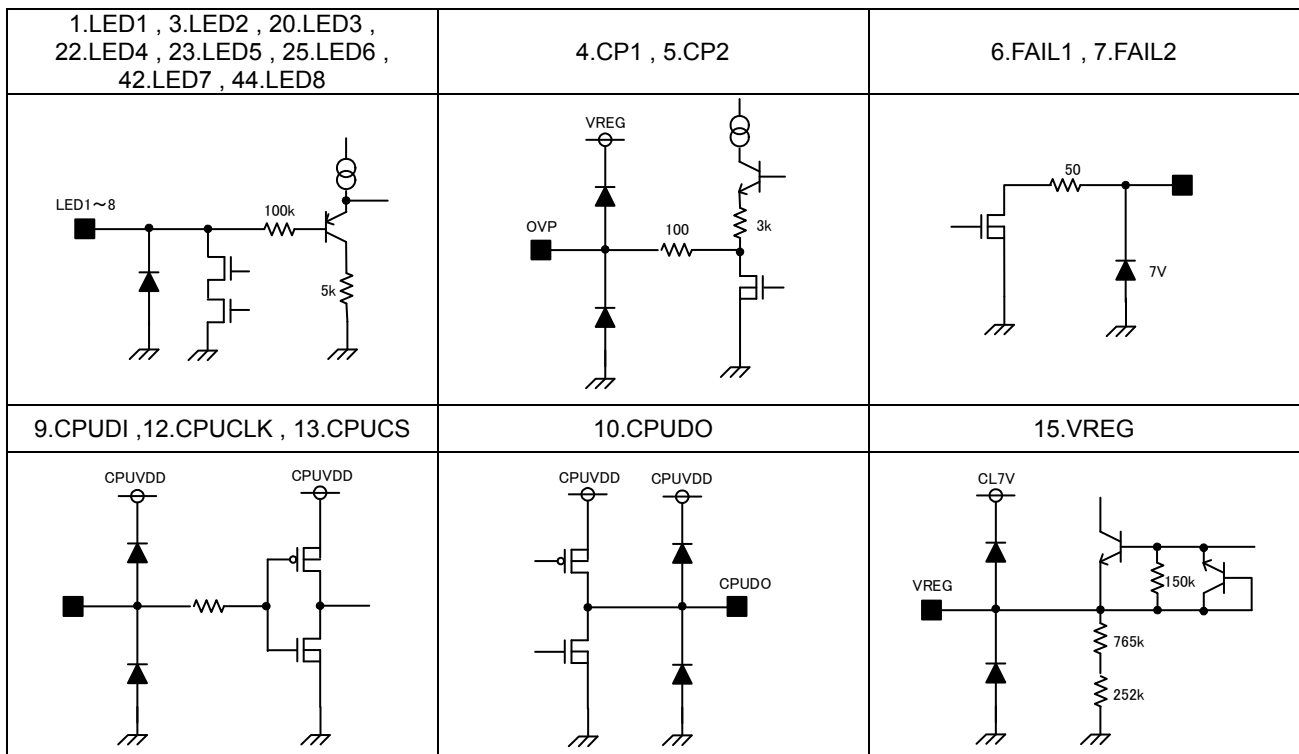

● In/Output Equivalent Circuit 2

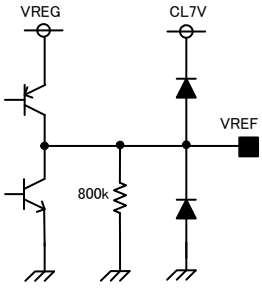
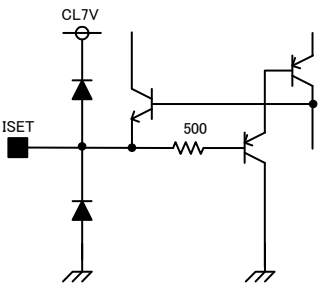
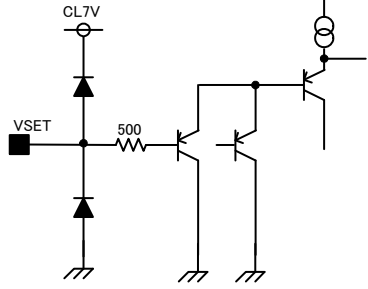
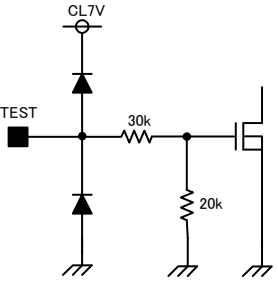
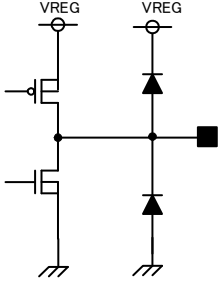
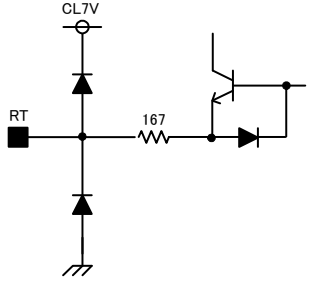
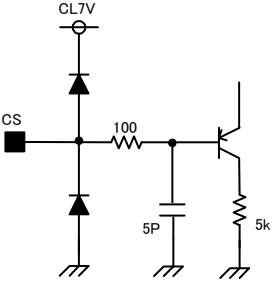
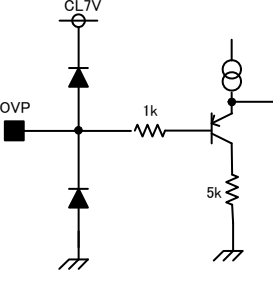
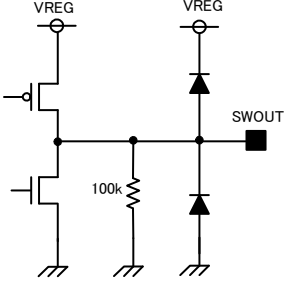
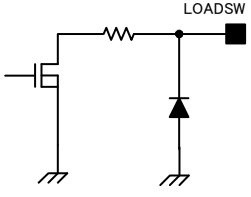
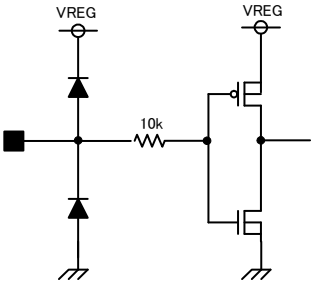
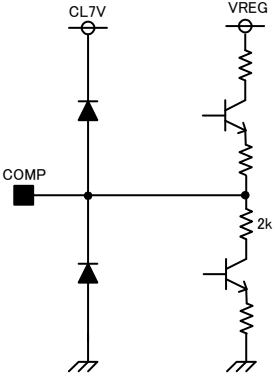
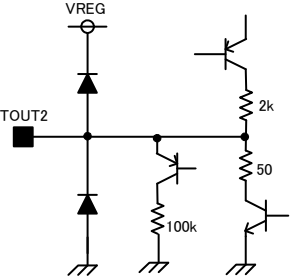
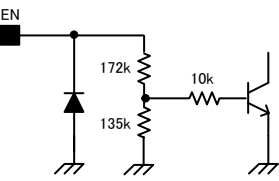
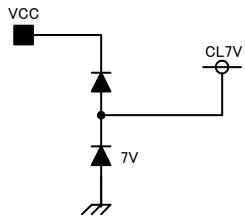
<p>16.VREF</p> 	<p>17.ISET</p> 	<p>18.VSET</p> 
<p>19.TEST</p> 	<p>26.TOUT1 , 35.CT_SYNC_OUT , 36.BCT_SYNC_OUT</p> 	<p>27.BRT , 28. RT</p> 
<p>29.CS</p>	<p>30.OVP, 34.UVLO</p>	<p>31.SWOUT</p>
		
<p>33.LOADSW</p>	<p>37.CT_SYNC_IN , 38.BCT_SYNC_IN</p>	<p>39.COMP</p>
		
<p>40.TOUT2</p>	<p>41.EN</p>	<p>CL7V</p>
		

● Usage Notes

1.) Absolute Maximum Ratings

Although the quality of this product has been tightly controlled, deterioration or even destruction may occur if the absolute maximum ratings, such as for applied pressure and operational temperature range, are exceeded. Furthermore, we are unable to assume short or open mode destruction conditions. If special modes, which exceed the absolute maximum ratings, are expected, physical safety precautions such as fuses should be considered.

2.) Reverse Connection of Power Supply Connector

The IC can destruct from reverse connection of the power supply connector. Precautions, such as inserting a diode between the external power supply and IC power terminal, should be taken as protection against reverse connection destruction.

3.) Power Supply Line

Because there is a return of current regenerated by back EMF of the external coil, the capacity value should be determined after confirming that there are no problems with characteristics such as capacity loss at low temperatures with electrolysis condensers, for example by placing a condenser between the power supply and GND as a route for the regenerated current.

4.) GND Potential

The potential of the GND pin should be at the minimum potential during all operation status

5.) Heat Design

Heat design should consider power dissipation (Pd) during actual use and margins should be set with plenty of room.

6.) Short-circuiting Between Terminals and Incorrect Mounting

When attaching to the printed substrate, pay special attention to the direction and proper placement of the IC. If the IC is attached incorrectly, it may be destroyed.

Destruction can also occur when there is a short, which can be caused by foreign objects entering between outputs or an output and the power GND.

7.) Operation in Strong Magnetic Fields

Exercise caution when operating in strong magnet fields, as errors can occur.

8.) ASO

When using this IC, it should be configured so that the output Tr should not exceed absolute maximum ratings and ASO. With CMOS ICs and ICs that have multiple power sources, there is a chance of rush current flowing momentarily, so exercise caution with power supply coupling capacity, power supply and width of GND pattern wiring and its layout.

9.) Heat Interruption Circuit

This IC has a built-in Temperature Protection Circuit (TSD circuit). The temperature protection circuit (TSD circuit) is only to cut off the IC from thermal runaway, and has not been designed to protect or guarantee the IC. Therefore, the user should not plan to activate this circuit with continued operation in mind.

10.) Inspection of Set Substrates

If a condenser is connected to a pin with low impedance when inspecting the set substrate, stress may be placed on the IC, so there should be a discharge after each process. Furthermore, when connecting a jig for the inspection process, the power must first be turned OFF before connection and inspection, and turned OFF again before removal.

11.) IC Terminal Input

This IC is a monolithic IC, and between each element there is a P+ isolation and P substrate for element separation.

There is a P-N junction formed between this P-layer and each element's N-layer, which makes up various parasitic elements.

For example, when resistance and transistor are connected with a terminal as in figure 15:

○When GND > (terminal A) at the resistance, or GND > (terminal B) at the transistor (NPN), the P-N junction operates as a parasitic diode.

○Also, when GND > (terminal B) at the transistor, a parasitic NPN transistor operates by the N-layer of other elements close to the aforementioned parasitic diode.

With the IC's configuration, the production of parasitic elements by the relationships of the electrical potentials is inevitable. The operation of the parasitic elements can also interfere with the circuit operation, leading to malfunction and even destruction. Therefore, uses that cause the parasitic elements to operate, such as applying voltage to the input terminal that is lower than the GND (P-substrate), should be avoided.

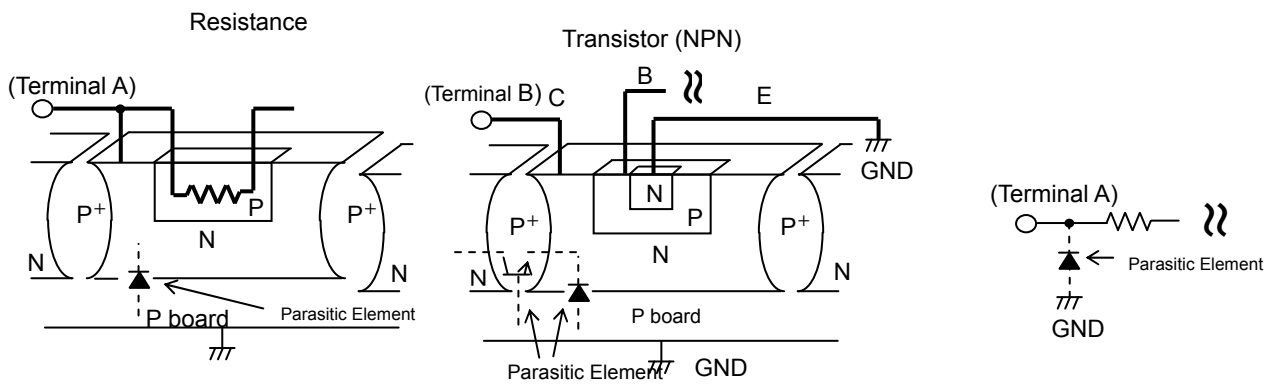
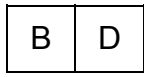

Fig.32 Simple Structure of Bipolar IC

12.) Earth Wiring Pattern

Where there are both a small signal GND and a large current GND, it is recommended that large current GND pattern and small signal GND pattern are separated, and that there is an earth at the set's control point so that the pattern wiring's resistance and voltage change from the large current doesn't change the small signal GND's voltage. Ensure that the GND wiring patterns for external parts do not fluctuate.

●Selecting a Model Name When Ordering



ROHM model name

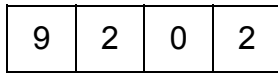

Part number

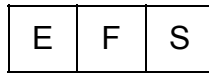

Package type
EFS = HTSSOP



Taping type
E2 = Reel-wound embossed taping

HTSSOP-A44

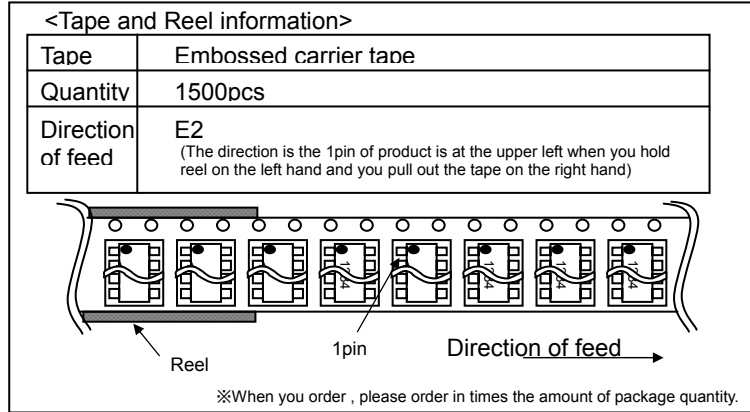
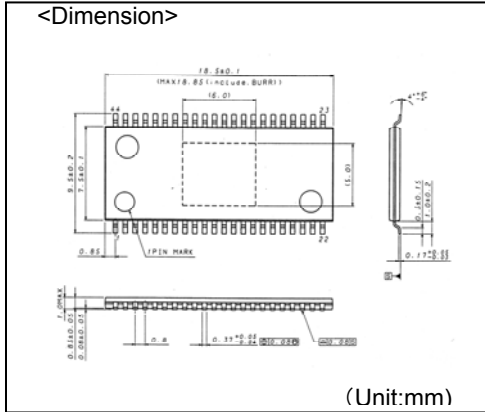

- The contents described herein are correct as of June, 2008
- The contents described herein are subject to change without notice. For updates of the latest information, please contact and confirm with ROHM CO.,LTD.
- Any part of this application note must not be duplicated or copied without our permission.
- Application circuit diagrams and circuit constants contained herein are shown as examples of standard use and operation. Please pay careful attention to the peripheral conditions when designing circuits and deciding upon circuit constants in the set.
- Any data, including, but not limited to application circuit diagrams and information, described herein are intended only as illustrations of such devices and not as the specifications for such devices. ROHM CO.,LTD. disclaims any warranty that any use of such devices shall be free from infringement of any third party's intellectual property rights or other proprietary rights, and further, assumes no liability of whatsoever nature in the event of any such infringement, or arising from or connected with or related to the use of such devices.
- Upon the sale of any such devices, other than for buyer's right to use such devices itself, resell or otherwise dispose of the same, implied right or license to practice or commercially exploit any intellectual property rights or other proprietary rights owned or controlled by ROHM CO., LTD. is granted to any such buyer.
- The products described herein utilize silicon as the main material.
- The products described herein are not designed to be X ray proof.

The products listed in this catalog are designed to be used with ordinary electronic equipment or devices (such as audio visual equipment, office-automation equipment, communications devices, electrical appliances and electronic toys). Should you intend to use these products with equipment or devices which require an extremely high level of reliability and the malfunction of which would directly endanger human life (such as medical instruments, transportation equipment, aerospace machinery, nuclear-reactor controllers, fuel controllers and other safety devices), please be sure to consult with our sales representative in advance.

Contact us for further information about the products.

Excellence in Electronics

ROHM

ROHM CO., LTD.

21, Saiin Mizosaki-cho, Ukyo-ku, Kyoto
615-8585, Japan
TEL: +81-75-311-2121 FAX: +81-75-315-0172
URL: <http://www.rohm.com>

Published by
LSI Business Promotion Dept.

- | | | |
|----------------|------------------------|------------------------|
| San Diego | TEL: +1-858-625-3630 | FAX: +1-858-625-3670 |
| Atlanta | TEL: +1-770-754-5972 | FAX: +1-770-754-0691 |
| Boston | TEL: +1-978-371-0382 | FAX: +1-928-438-7164 |
| Chicago | TEL: +1-847-368-1006 | FAX: +1-847-368-1008 |
| Dallas | TEL: +1-469-287-5366 | FAX: +1-469-362-7973 |
| Denver | TEL: +1-303-708-0908 | FAX: +1-303-708-0858 |
| Detroit | TEL: +1-248-348-9920 | FAX: +1-248-348-9942 |
| Nashville | TEL: +1-615-620-6700 | FAX: +1-615-620-6702 |
| Mexico | TEL: +52-33-3123-2001 | FAX: +52-33-3123-2002 |
| Düsseldorf | TEL: +49-2154-9210 | FAX: +49-2154-921400 |
| Munich | TEL: +49-8161-48310 | FAX: +49-8161-483120 |
| Stuttgart | TEL: +49-711-72723710 | FAX: +49-711-72723720 |
| France | TEL: +33-1-5697-3060 | FAX: +33-1-5697-3080 |
| United Kingdom | TEL: +44-1-908-306700 | FAX: +44-1-908-235788 |
| Denmark | TEL: +45-3694-4739 | FAX: +45-3694-4789 |
| Barcelona | TEL: +34-9375-24320 | FAX: +34-9375-24410 |
| Hungary | TEL: +36-1-4719338 | FAX: +36-1-4719339 |
| Poland | TEL: +48-22-5757213 | FAX: +48-22-5757001 |
| Russia | TEL: +7-95-980-6755 | FAX: +7-95-937-8290 |
| Seoul | TEL: +82-2-8182-700 | FAX: +82-2-8182-715 |
| Masan | TEL: +82-55-240-6234 | FAX: +82-55-240-6236 |
| Dalian | TEL: +86-411-8230-8549 | FAX: +86-411-8230-8537 |
| Beijing | TEL: +86-10-8525-2483 | FAX: +86-10-8525-2489 |
| Tianjin | TEL: +86-22-23029181 | FAX: +86-22-23029183 |

- | | | |
|--------------|------------------------|------------------------|
| Shanghai | TEL: +86-21-6279-2727 | FAX: +86-21-6247-2066 |
| Hangzhou | TEL: +86-571-87658072 | FAX: +86-571-87658071 |
| Nanjing | TEL: +86-25-8689-0015 | FAX: +86-25-8689-0393 |
| Ningbo | TEL: +86-574-87654201 | FAX: +86-574-87654208 |
| Qingdao | TEL: +86-532-5779-312 | FAX: +86-532-5779-653 |
| Suzhou | TEL: +86-512-6807-1300 | FAX: +86-512-6807-2300 |
| Wuxi | TEL: +86-510-82702693 | FAX: +86-510-82702992 |
| Shenzhen | TEL: +86-755-8307-3008 | FAX: +86-755-8307-3003 |
| Dongguan | TEL: +86-769-8393-3320 | FAX: +86-769-8398-4140 |
| Fuzhou | TEL: +86-591-8801-8698 | FAX: +86-591-8801-8690 |
| Guangzhou | TEL: +86-20-8364-9796 | FAX: +86-20-8364-9707 |
| Huizhou | TEL: +86-752-205-1054 | FAX: +86-752-205-1059 |
| Xiamen | TEL: +86-592-238-5705 | FAX: +86-592-239-8380 |
| Zhuhai | TEL: +86-756-3232-480 | FAX: +86-756-3232-460 |
| Hong Kong | TEL: +852-2-740-6262 | FAX: +852-2-375-8971 |
| Taipei | TEL: +886-2-2500-6956 | FAX: +886-2-2503-2869 |
| Kaohsiung | TEL: +886-7-237-0881 | FAX: +886-7-238-7332 |
| Singapore | TEL: +65-6332-2322 | FAX: +65-6332-5662 |
| Philippines | TEL: +63-2-807-6872 | FAX: +63-2-809-1422 |
| Thailand | TEL: +66-2-254-4890 | FAX: +66-2-256-6334 |
| Kuala Lumpur | TEL: +60-3-7958-8355 | FAX: +60-3-7958-8377 |
| Penang | TEL: +60-4-2286453 | FAX: +60-4-2286452 |
| Kyoto | TEL: +81-75-365-1218 | FAX: +81-75-365-1228 |
| Yokohama | TEL: +81-45-476-2290 | FAX: +81-45-476-2295 |

Catalog No.08T193A '08.6 ROHM © 1000 NZ

Notes

- No technical content pages of this document may be reproduced in any form or transmitted by any means without prior permission of ROHM CO.,LTD.
- The contents described herein are subject to change without notice. The specifications for the product described in this document are for reference only. Upon actual use, therefore, please request that specifications to be separately delivered.
- Application circuit diagrams and circuit constants contained herein are shown as examples of standard use and operation. Please pay careful attention to the peripheral conditions when designing circuits and deciding upon circuit constants in the set.
- Any data, including, but not limited to application circuit diagrams information, described herein are intended only as illustrations of such devices and not as the specifications for such devices. ROHM CO.,LTD. disclaims any warranty that any use of such devices shall be free from infringement of any third party's intellectual property rights or other proprietary rights, and further, assumes no liability of whatsoever nature in the event of any such infringement, or arising from or connected with or related to the use of such devices.
- Upon the sale of any such devices, other than for buyer's right to use such devices itself, resell or otherwise dispose of the same, no express or implied right or license to practice or commercially exploit any intellectual property rights or other proprietary rights owned or controlled by
- ROHM CO., LTD. is granted to any such buyer.
- Products listed in this document are no antiradiation design.

The products listed in this document are designed to be used with ordinary electronic equipment or devices (such as audio visual equipment, office-automation equipment, communications devices, electrical appliances and electronic toys).

Should you intend to use these products with equipment or devices which require an extremely high level of reliability and the malfunction of which would directly endanger human life (such as medical instruments, transportation equipment, aerospace machinery, nuclear-reactor controllers, fuel controllers and other safety devices), please be sure to consult with our sales representative in advance.

It is our top priority to supply products with the utmost quality and reliability. However, there is always a chance of failure due to unexpected factors. Therefore, please take into account the derating characteristics and allow for sufficient safety features, such as extra margin, anti-flammability, and fail-safe measures when designing in order to prevent possible accidents that may result in bodily harm or fire caused by component failure. ROHM cannot be held responsible for any damages arising from the use of the products under conditions out of the range of the specifications or due to non-compliance with the NOTES specified in this catalog.

Thank you for your accessing to ROHM product informations.

More detail product informations and catalogs are available, please contact your nearest sales office.

ROHM Customer Support System

THE AMERICAS / EUROPE / ASIA / JAPAN

www.rohm.com

Contact us : webmaster@rohm.co.jp