

700mA Buck/Boost Charge Pump LED Driver

FEATURES

- Output Current up to 700mA
- Up to 94% Efficiency in Torch Mode
- Adjustable FLASH Mode Current
- Minimum External Components: No Inductors
- Automatic Buck/Boost Mode Switchover
- Wide V_{IN} Range: 2.7V to 5.5V
- High Frequency Operation: 2.4 MHz
- Low 50mV Reference for low Loss Sensing
- $I_Q < 1\mu A$ in Shutdown
- PWM Dimming Control
- Automatic Soft Start Limits Inrush Current
- Overvoltage Protection on Output
- Overcurrent/Temperature Protection
- Low Ripple and EMI
- Ultra-low Dropout Voltage in Buck Mode
- Space Saving 10-pin 3mm x 3mm DFN Package

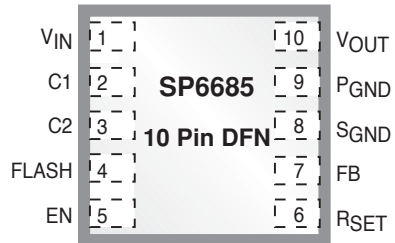

Now Available in Lead Free Packaging

APPLICATIONS

- White LED Torch/Flash for Cell Phones, DSCs, and Camcorders
- White LED Backlighting
- Generic Lighting/Flash/Strobe Applications
- General Purpose High Current Boost

DESCRIPTION

The SP6685 is a current-regulated charge pump ideal for powering high brightness LEDs for camera flash applications. The charge pump can be set to regulate two current levels for FLASH and TORCH modes. The SP6685 automatically switches modes between step-up and step-down ensuring that LED current does not depend on the forward voltage. A low current sense reference voltage (50mV) allows the use of small 0603 current sensing resistors. The SP6685 is offered in the 10-pin DFN package.

TYPICAL APPLICATION CIRCUIT

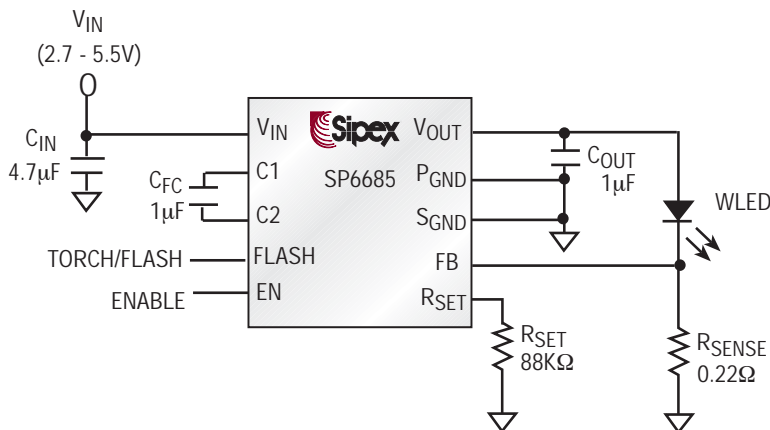

ABSOLUTE MAXIMUM RATINGS

V _{IN} , V _{OUT}	-0.3V to 6V
Output Current Pulse (Flash)	1A
Output Current Continuous (Torch)	0.4A
Storage Temperature	-65°C to +150°C
Operating Temperature	-40°C to +85°C
V _{EN}	0.0V to 7V
3mmx3mm 10 DFN	Θ _{JA} = 57.1°C/W
ESD Rating	2kV HBM

These are stress ratings only and functional operation of the device at these ratings or any other above those indicated in the operation sections of the specifications below is not implied. Exposure to absolute maximum rating conditions for extended periods of time may affect reliability.

ELECTRICAL CHARACTERISTICS

T_A = -40°C to +85°C, V_{IN} = 3.6V, C_{IN} = 4.7μF, C_{FC} = C_{OUT} = 1.0μF, V_{SHDN} = V_{IN}, typical values at 25°C. The ♦ denotes the specifications which apply over the full operating temperature range unless otherwise noted.

PARAMETER	MIN.	TYP.	MAX.	UNITS		CONDITIONS
Operating Input Voltage	2.7		5.5	V	♦	
Quiescent Current		0.5	3	mA	♦	V _{IN} = 2.7 - 5.5V FLASH = 0.0V, I _{LOAD} = 100μA
		2				FLASH = V _{IN} , 2x mode
Shutdown Current			1	μA		V _{IN} = 5.5V, V _{EN} = 0.0V
Oscillator Frequency		2.4		MHz		
Charge Pump Equivalent Resistance (x2 mode)		5				V _{FB} = 0.0V, V _{IN} = 3.6V
Charge Pump Equivalent Resistance (x1 mode)		0.6	0.8			V _{IN} = 3.6V
FB Reference Voltage	138	150	162	mV	♦	FLASH = V _{IN} R _{SET} = 88.7K
FB Reference Voltage	45	50	55	mV	♦	FLASH = GND
FB Pin Current			0.5	μA		V _{FB} = 0.3V
EN, FLASH Logic Low			0.4	V	♦	
EN, FLASH Logic High	1.3			V	♦	
EN, FLASH Pin Current			0.5	μA	♦	
V _{OUT} Turn-on Time		250	500	μs	♦	V _{IN} = 3.6V, FB within 90% of regulation
Thermal Shutdown Temperature		145		°C		

PIN NUMBER	PIN NAME	DESCRIPTION
1	V _{IN}	Input Voltage for the charge pump. Decouple with 4.7μF ceramic capacitor close to the pins of the IC.
2	C1	Positive input for the external fly capacitor. Connect a ceramic 1μF capacitor close to the pins of the IC.
3	C2	Negative input for the external fly capacitor. Connect a ceramic 1μF capacitor close to the pins of the IC.
4	FLASH	Logic input to toggle operation between FLASH and TORCH mode. In TORCH mode FB is regulated to the internal 50mV reference. In FLASH mode FB reference voltage can be adjusted by changing the resistor from R _{SET} pin to ground. Choose the external current sense resistor (R _{SENSE}) based on desired current in TORCH mode.
5	EN	Shutdown control input. Connect to V _{IN} for normal operation, connect to ground for shutdown.
6	R _{SET}	Connect a resistor from this pin to ground. When in FLASH mode (FLASH = High) this resistor sets the current regulation point according to the following: $V_{FB} = (1.26V / R_{SET}) * 11.2K\Omega$.
7	FB	Feedback input for the current control loop. Connect directly to the current sense resistor.
8	S _{GND}	Internal ground pin. Control circuitry returns current to this pin.
9	P _{GND}	Power ground pin. Fly capacitor current returns through this pin.
10	V _{OUT}	Charge Pump Output Voltage. Decouple with an external capacitor. At least 1μF is recommended. Higher capacitor values reduce output ripple.

TYPICAL PERFORMANCE CHARACTERISTICS

$V_{IN} = 3.6V$, Typical Application Circuit, D1 = Luxeon LXCL-PWF1, $T_A = 25^\circ C$ unless otherwise noted.

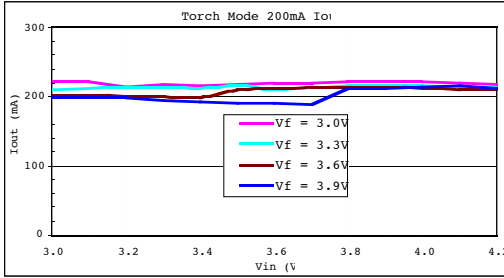

Figure 1. Torch Mode Output Current

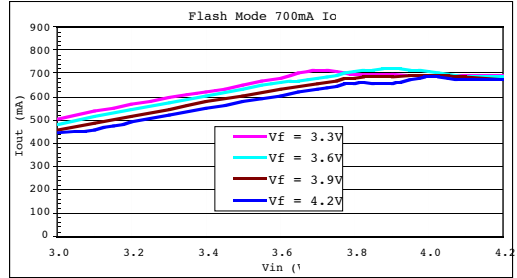

Figure 2. Flash Mode Output Current

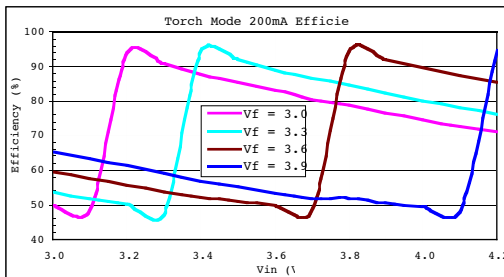

Figure 3. Torch Mode Efficiency

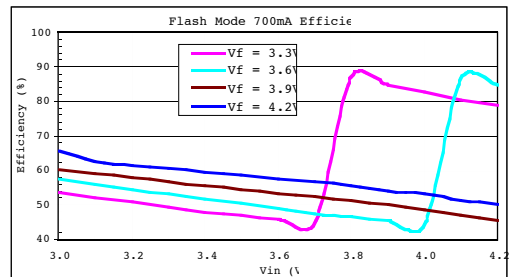

Figure 4. Flash Mode Efficiency

TYPICAL PERFORMANCE CHARACTERISTICS

$V_{IN} = 3.6V$, Typical Application Circuit, D1 = Luxeon LXCL-PWF1, $T_A = 25^\circ C$ unless otherwise noted.

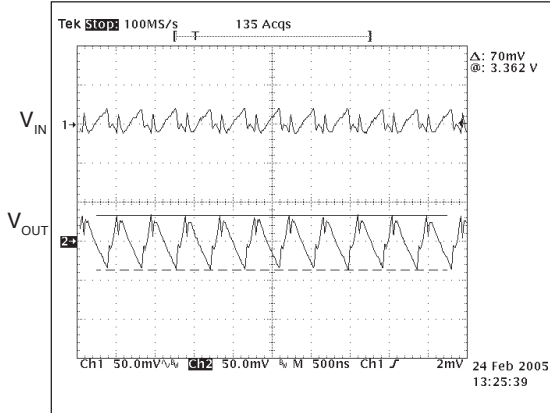

Figure 5. PWF1 Ripple 1X Flash 700mA Ch1 = V_{IN} , Ch2 = V_{OUT} , $V_{IN} = 4.2V$, $C_{IN} = 10\mu F$, $C_{FC} = 1\mu F$, $C_{OUT} = 4.7\mu F$

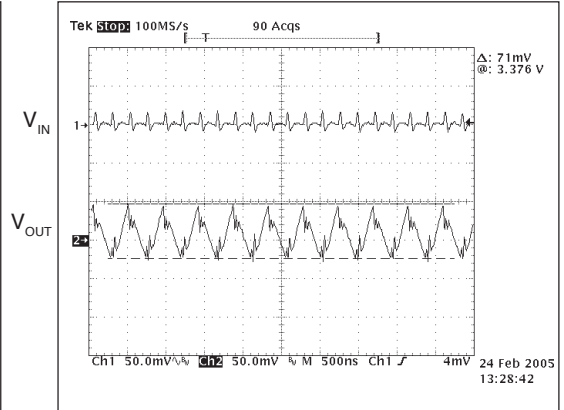

Figure 6. PWF1 Ripple 2X Flash 700mA Ch1 = V_{IN} , Ch2 = V_{OUT} , $V_{IN} = 3.6V$, $C_{IN} = 10\mu F$, $C_{FC} = 1\mu F$, $C_{OUT} = 4.7\mu F$

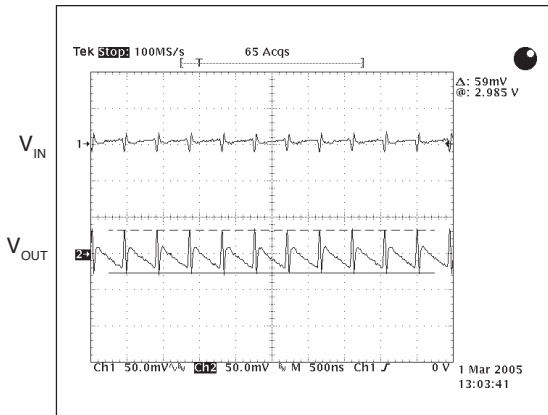

Figure 7. PWF1 Ripple 1X Torch 200mA $V_{IN} = 4.2V$, $C_{IN} = 10\mu F$, $C_{FC} = 1\mu F$, $C_{OUT} = 4.7\mu F$

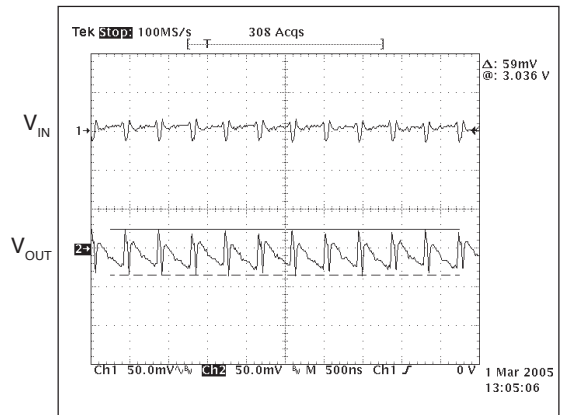

Figure 8. PWF1 Ripple 2X Torch 200mA $V_{IN} = 3.0V$, $C_{IN} = 10\mu F$, $C_{FC} = 1\mu F$, $C_{OUT} = 4.7\mu F$

TYPICAL PERFORMANCE CHARACTERISTICS

$V_{IN} = 3.6V$, Typical Application Circuit, D1 = Luxeon LXCL-PWF1, $T_A = 25^\circ C$ unless otherwise noted.

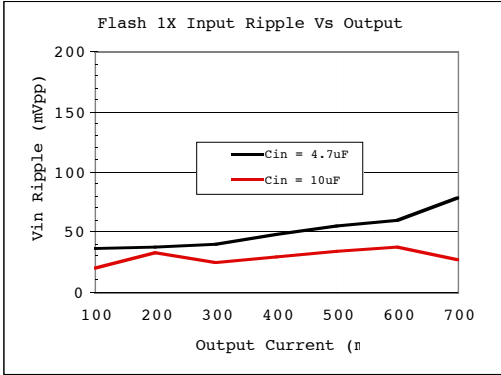

Figure 9. $C_{OUT} = 4.7\mu F$

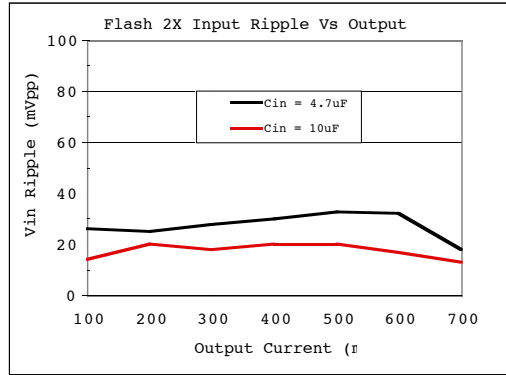

Figure 10. $C_{OUT} = 4.7\mu F$

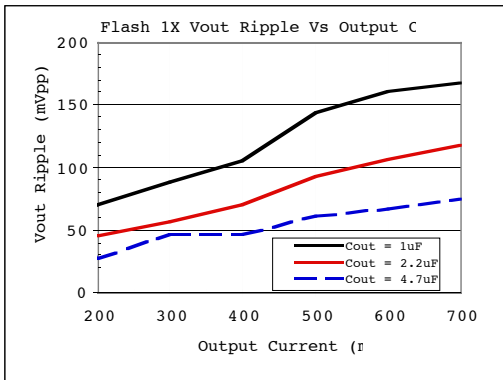

Figure 11. $C_{IN} = 10\mu F$

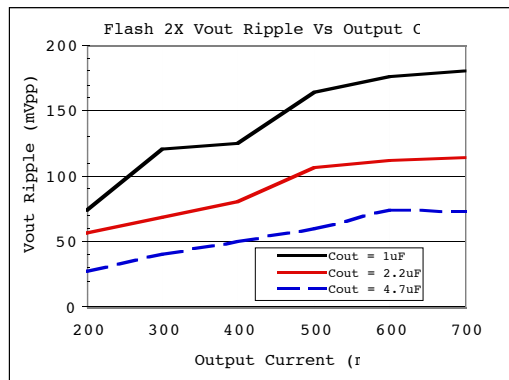

Figure 12. $C_{IN} = 10\mu F$

TYPICAL PERFORMANCE CHARACTERISTICS

D1 = Luxeon LXCL-PWFI LED, $R_{sense} = 0.22\Omega$,
 $R_{SET} = 88.7K$, $C_{IN} = 4.7\mu F$, $C_{FC} = 1.0\mu F$, $C_{OUT} = 1.0\mu F$

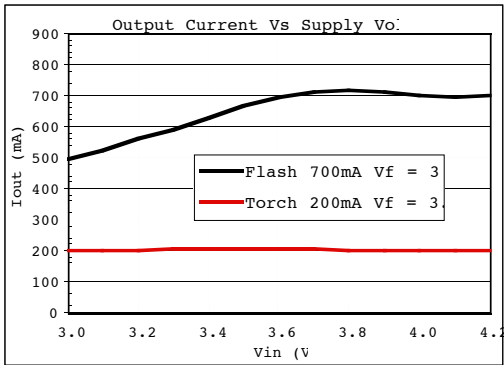

Figure 13.

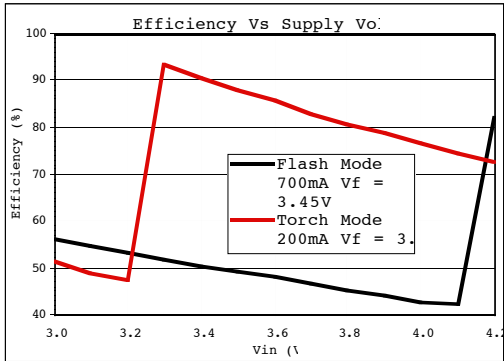

Figure 14.

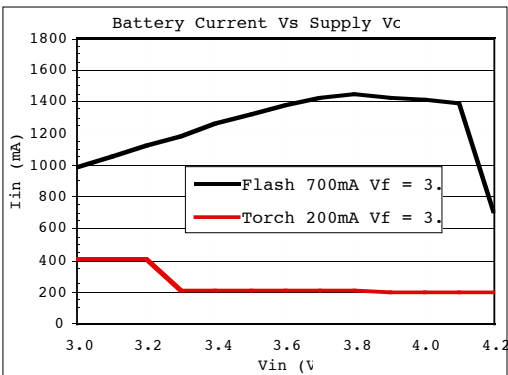

Figure 15.

Note: diode, resistor, and capacitor settings apply to figures 13, 14, and 15.

D1 = AOT 3228HPW0303B LED, $R_{sense} = 0.33\Omega$,
 $R_{SET} = 162K$, $C_{IN} = 4.7\mu F$, $C_{FC} = 0.47\mu F$, $C_{OUT} = 1\mu F$

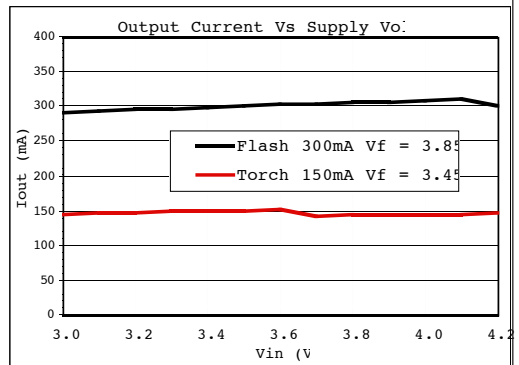

Figure 16.

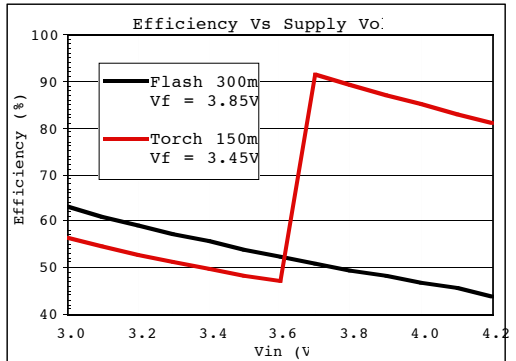

Figure 17.

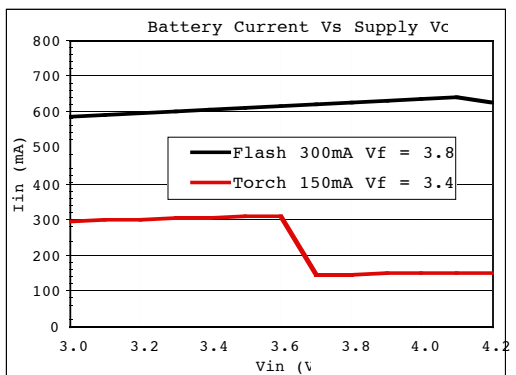

Figure 18.

Note: diode, resistor, and capacitor settings apply to figures 16, 17, and 18.

TYPICAL PERFORMANCE CHARACTERISTICS

D1 = AOT 6060HPW0305BD LED, $R_{sense} = 0.33\Omega$,
 $R_{SET} = 75K$, $C_{IN} = 4.7\mu F$, $C_{FC} = 1.0\mu F$, $C_{OUT} = 1.0\mu F$

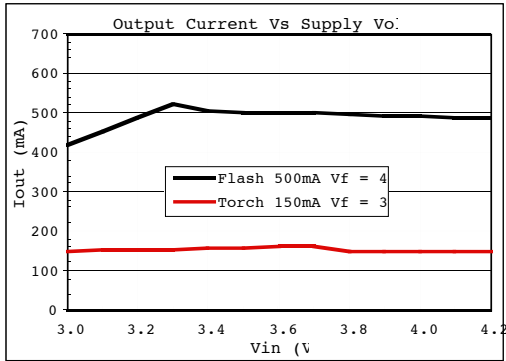

Figure 19.

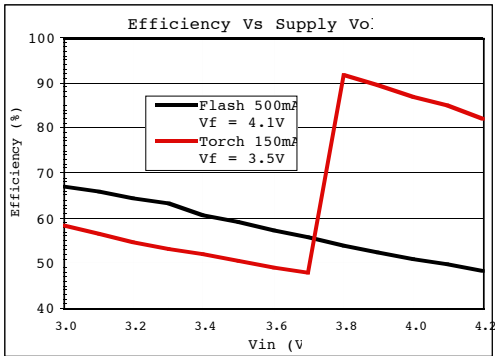

Figure 20.

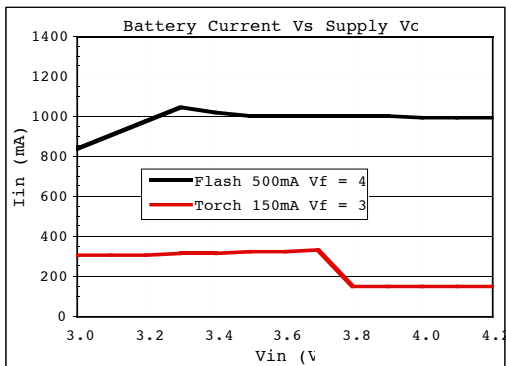

Figure 21.

Note: diode, resistor, and capacitor settings apply to figures 19, 20, and 21.

D1 = AOT 2015HPW-1915BLED, $R_{sense} = 0.22\Omega$,
 $R_{SET} = 80.6K$, $C_{IN} = 4.7\mu F$, $C_{FC} = 1.0\mu F$, $C_{OUT} = 1.0\mu F$

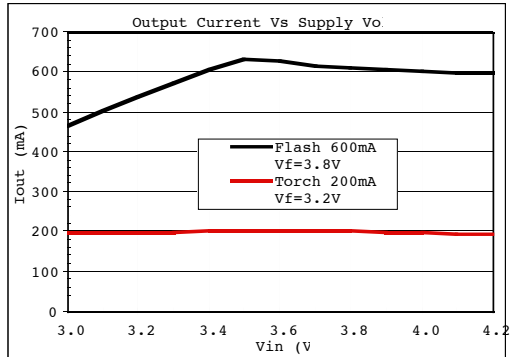

Figure 22.

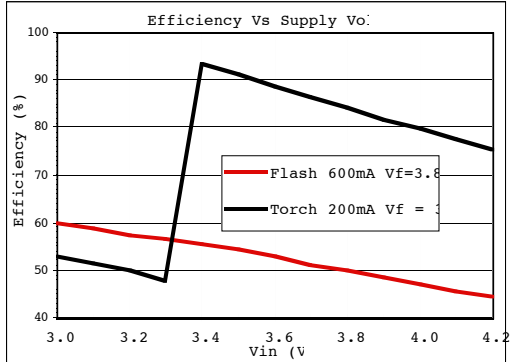

Figure 23.

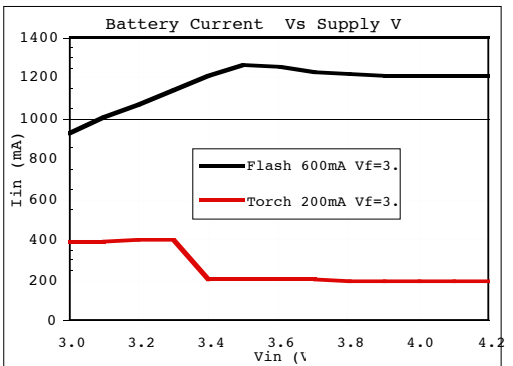

Figure 24.

Note: diode, resistor, and capacitor settings apply to figures 22, 23, and 24.

TYPICAL PERFORMANCE CHARACTERISTICS

$V_{IN} = 3.6V$, Typical Application Circuit, D1 = Luxeon LXCL-PWF1, $T_A = 25^\circ C$ unless otherwise noted.

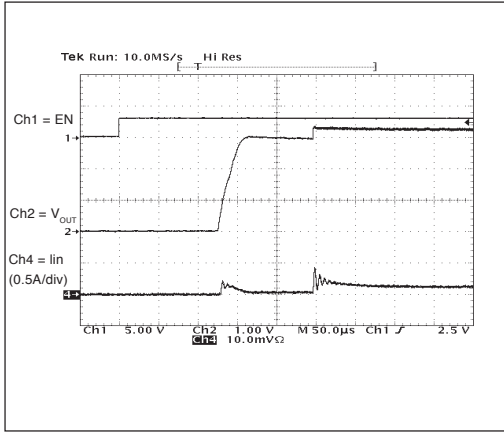

Figure 25. Startup 200mA Torch,
 $V_{IN} = 3.6V$, $V_{OUT} = 3.2V$

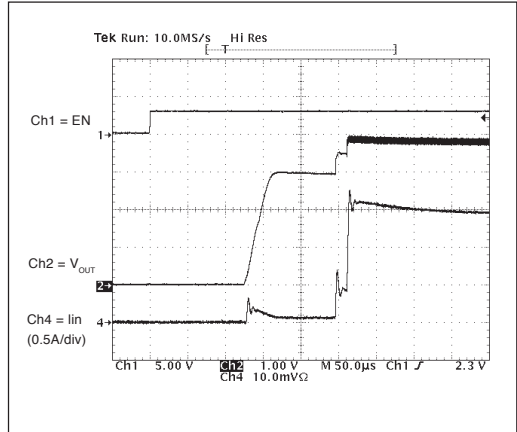

Figure 26. Startup 700mA Flash,
 $V_{IN} = 3.6V$, $V_{OUT} = 3.6V$

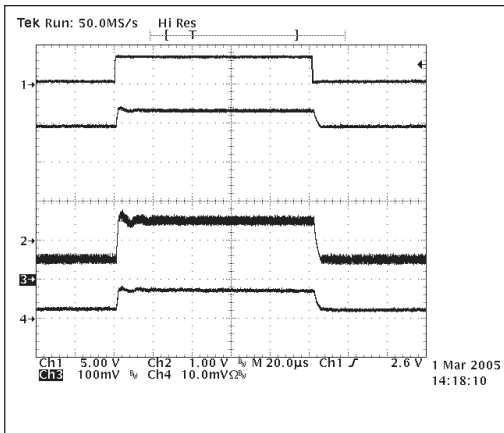

Figure 27. Torch in 1X to Flash in 1X Mode $V_{IN} = 4.2V$.
 CH1 = FLASH, CH2 = V_{OUT} , CH3 = V_{FB} , CH4 = I_{OUT} 1A/div.

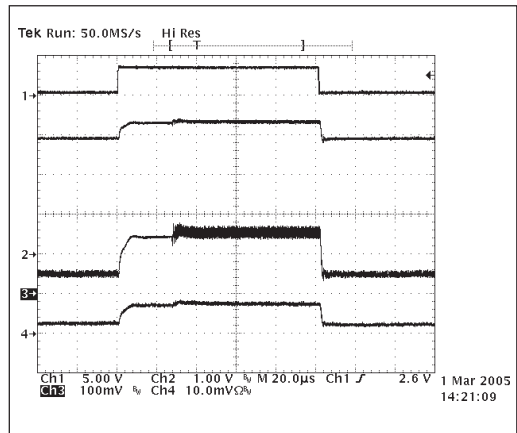

Figure 28. Torch in 1X to Flash in 2X Mode $V_{IN} = 3.6V$.
 CH1 = FLASH, CH2 = V_{OUT} , CH3 = V_{FB} , CH4 = I_{OUT} 1A/div.

TYPICAL PERFORMANCE CHARACTERISTICS

Application Circuit = Figure 31, $T_A = 25^\circ\text{C}$.

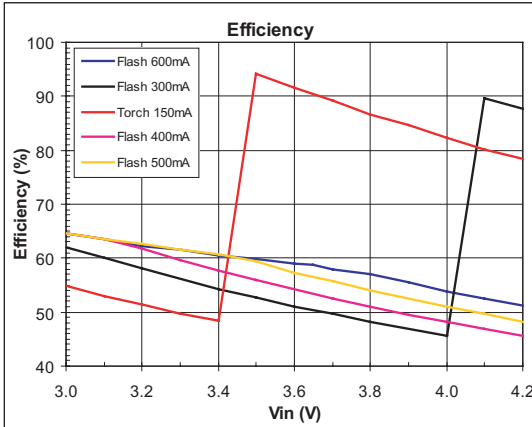

Figure 29. Efficiency vs. V_{in} .

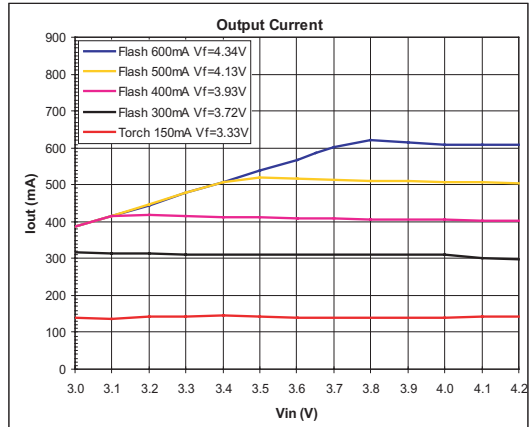

Figure 30. Output Current vs. V_{in} .

APPLICATION INFORMATION

The SP6685 can be used with multiple LEDs in parallel as shown in figure 31. For best performance, the LEDs should be in a single package, preferably from a single die to have better matching for forward voltage V_f for a given forward current I_f . In practice, if the V_f of one LED is higher than the others, it will consume a larger I_f , which will raise its temperature which will then cause its V_f to reduce, correcting the imbalance. The overall current will be the sum of the individual currents, for example $I_{total} = 4 * I_{LED}$.

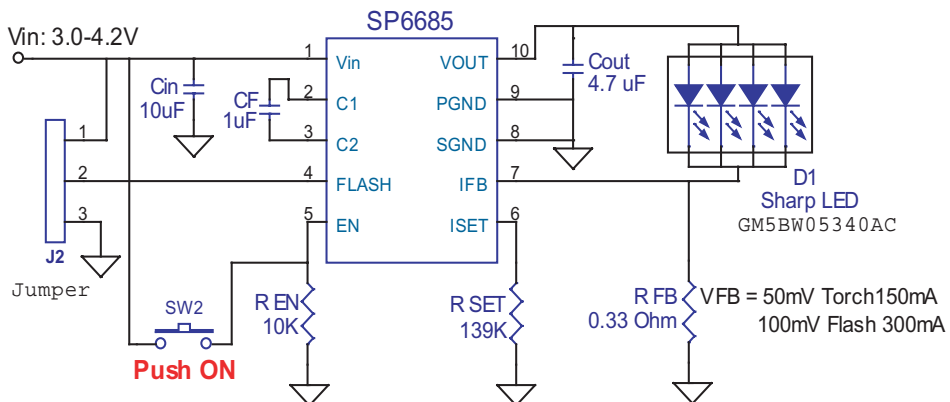
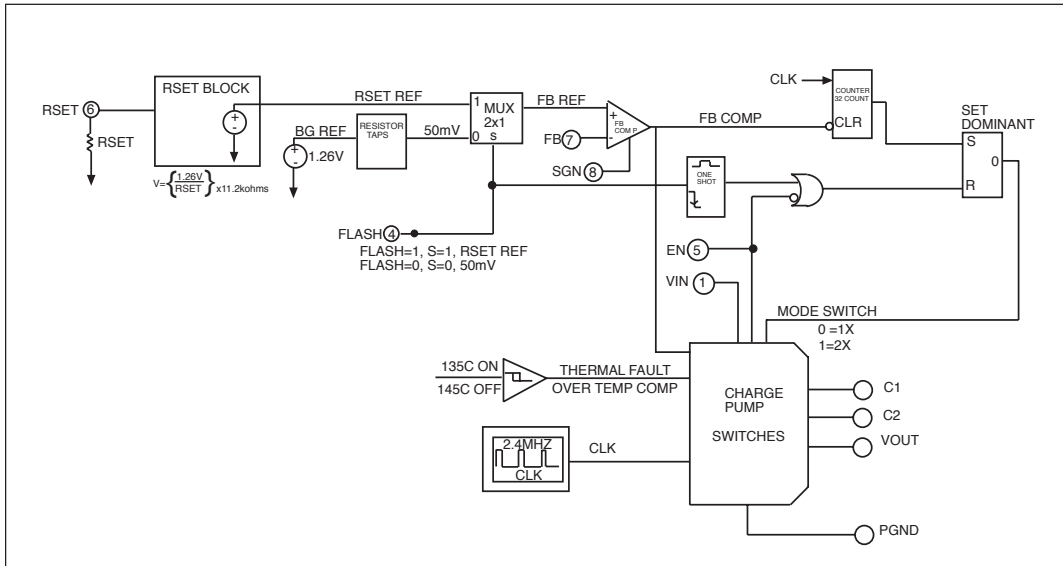

Figure 31. MULTIPLE LED FLASH CIRCUIT.



THEORY OF OPERATION

The SP6685 is a charge pump regulator designed for converting a Li-Ion battery voltage of 2.7V to 4.2V to drive a white LED used in digital still camera Flash and Torch applications. The SP6685 has two modes of operation which are pin selectable for either Flash or Torch. Flash mode is usually used with a pulse of about 200 to 300 milliseconds to generate a high intensity Flash. Torch can be used continuously at a lower output current than Flash and is often used for several seconds in a digital still camera “movie” mode.

The SP6685 also has two modes of operation to control the output current: the 1X mode and 2X mode. Operation begins after the enable pin EN receives a logic high, the bandgap reference wakes up after 200µsec, and then SP6685 goes through a soft-start mode designed to reduce inrush current. The SP6685 starts in the 1X mode, which acts like a linear regulator to control the output current by continuously monitoring the feedback pin FB. In 1X mode, if the

SP6685 auto detects a dropout condition, which is when the FB pin is below the regulation point for more than 32 cycles of the internal clock, the SP6685 automatically switches to the 2X mode. The SP6685 remains in the 2X mode until one of four things happens: 1) the enable pin EN has been toggled, 2) the Flash pin has changed from high to low, 3) V_{IN} is cycled or, 4) a thermal fault occurs.

The 2X mode is the charge pump mode where the output can be pumped as high as two times the input voltage, provided the output does not exceed the maximum voltage for the SP6685, which is internally limited to about 5.5V. In the 2X mode, as in the 1X mode, the output current is regulated by the voltage at the FB pin.

In the Torch mode, (Flash = GND) the Flash pin is set to logic low and the SP6685 FB pin regulates to 50mV output:

$$V_{FB} = 50\text{mV (Torch Mode)}$$

When in Flash mode, ($V_{FB} = V_{IN}$), the FB regulation voltage is set by the resistor R_{SET} connected between the R_{SET} pin and S_{GND} and the equation:

$$V_{FB} = (1.26V / R_{SET}) * 11.2K\Omega \text{ (Flash Mode)}$$

Where 1.26V is the internal bandgap reference voltage and 11.2K Ω is an internal resistance used to scale the R_{SET} current. Typical values of R_{SET} are 40K Ω to 180K Ω for a range of $V_{FB} = 300mV$ to 75mV in Flash mode.

The output current is then set in either Flash or Torch mode by the equation:

$$I_{OUT} = V_{FB} / R_{SENSE}$$

OVERTEMPERATURE PROTECTION

When the temperature of the SP6685 rises above 145 degrees Celsius, the over temperature protection circuitry turns off the output switches to prevent damage to the device. If the temperature drops back down below 135 degrees Celsius, the part automatically recovers and executes a soft start cycle.

OVERVOLTAGE PROTECTION

The SP6685 has over voltage protection. If the output voltage rises above the 5.5V threshold, the over voltage protection shuts

off all of the output switches to prevent the output voltage from rising further. When the output decreases below 5.5V, the device resumes normal operation.

OVERCURRENT PROTECTION

The over current protection circuitry monitors the average current out of the $V_{OUT} = 50mV$ (Torch Mode) pin. If the average output current exceeds approximately 1Amp, then the over current protection circuitry shuts off the output switches to protect the chip.

COMPONENT SELECTION

The SP6685 charge pump circuit requires 3 capacitors: 4.7 μF input, 1 μF output and 1 μF fly capacitor are typically recommended. For the input capacitor, a larger value of 10 μF will help reduce input voltage ripple for applications sensitive to ripple on the battery voltage. All the capacitors should be surface mount ceramic for low lead inductance necessary at the 2.4MHz switching frequency of the SP6685 and to obtain low ESR, which improves bypassing on the input and output and improves output voltage drive by reducing output resistance. Ceramic capacitors with X5R or X7R temperature grade are recommended for most applications. A selection of recommended capacitors is included in Table 1 below.

Manufacturers Website	Part Number	Capacitance/Voltage	Capacitor Size/Type/Thickness	ESR at 100KHz
TDK/www.tdk.com	C1005X5R0J105M	1 μF /6.3V	0402/X5R/0.5mm	0.03
TDK/www.tdk.com	C1608X5R0J475K	4.7 μF /6.3V	0603/X5R/0.9mm	0.02
TDK/www.tdk.com	C2012X5R0J106M	10 μF /6.3V	0805/X5R/1.35mm	0.02
Murata/www.murata.com	GRM155R60J105KE19B	1 μF /6.3V	0402/X5R/0.55mm	0.03
Murata/www.murata.com	GRM188R60J475KE19	4.7 μF /6.3V	0603/X5R/0.9mm	0.02
Murata/www.murata.com	GRM21BR60J106KE19L	10 μF /6.3V	0805/X5R/1.35mm	0.02

Table 1: Recommended Capacitors

The input and output capacitors should be located as close to the V_{IN} and V_{OUT} pins as possible to obtain best bypassing, and the returns should be connected directly to the P_{GND} pin or to the thermal pad ground located under the SP6685. The fly capacitor should be located as close to the C1 and C2 pins as possible. See typical circuit layout (page 13) for details on the recommended layout.

To obtain lower output ripple, the C_{OUT} value can be increased from $1\mu F$ to $2.2\mu F$ or $4.7\mu F$ with a corresponding decrease in output ripple as shown in the Typical Performance Characteristic curves. For output currents of 500mA to 700mA, the recommended C_{FC} fly capacitor value of $1\mu F$ should be used. Output currents in Flash of 100mA to 400mA can use a $0.47\mu F$ C_{FC} but a minimum $1\mu F$ C_{OUT} is still needed.

RESISTOR SELECTION

The sense resistor R_{SENSE} is determined by the value needed in the Torch mode for the desired output current by the equation:

$$R_{SENSE} = V_{FB} / I_{OUT} \text{ where } V_{FB} = 50mV \text{ (Torch Mode)}$$

Once the R_{SENSE} resistor has been selected

for Torch mode, the V_{FB} voltage can be selected for Flash mode using the following equation:

$$V_{FB} = I_{OUT} * R_{SENSE} \text{ (Flash Mode) where } I_{OUT} \text{ is for Flash Mode.}$$

Next, the R_{SET} resistor can be selected for Flash mode using the following equation:

$$R_{SET} = (1.26V / V_{FB}) * 11.2K\Omega \text{ (Flash Mode)}$$

For an example of 200mA Torch mode and 600mA Flash mode, the values $R_{SENSE} = 0.25\Omega$, $V_{FB} = 150mV$ (Flash Mode), and $R_{SET} = 94K\Omega$ are calculated. The power obtained in the Flash mode would be:

$$P_{FLASH} = V_{FB} * I_{OUT} = 150mV * 600mA = 90mW.$$

The typical 0603 surface mount resistor is rated 1/10 Watt continuous power and 1/5 Watt pulsed power, more than enough for this application. For other applications, the P_{FLASH} power can be calculated and resistor size selected. The R_{SENSE} resistor is recommended to be size 0603 for most applications. The range of typical resistor values and sizes are shown here in Table 2.

Part Reference	Value	Tolerance	Size	Manufacturers
RSET	68k	5%	0402	any
RSET	75k	5%	0402	any
RSET	82k	5%	0402	any
RSET	91k	5%	0402	any
RSET	100k	5%	0402	any
RSET	110k	5%	0402	any
RSET	120k	5%	0402	any
RSET	130k	5%	0402	any
RSET	140k	5%	0402	any
RSET	150k	5%	0402	any
RSENSE	0.22	5%	0603	Panasonic or Vishay
RSENSE	0.27	5%	0603	Panasonic or Vishay
RSENSE	0.33	5%	0603	Panasonic or Vishay
RSENSE	0.39	5%	0603	Panasonic or Vishay
RSENSE	0.47	5%	0603	Panasonic or Vishay

Table 2: Resistor values and sizes

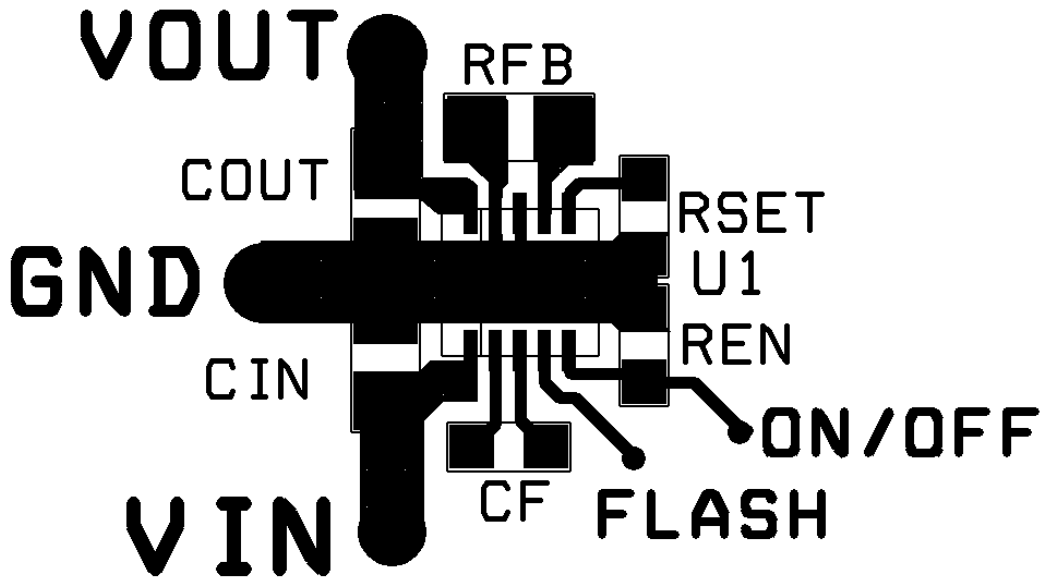

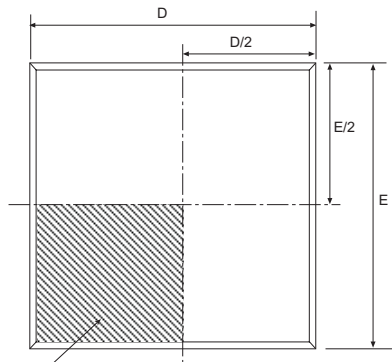

Pin1 Designator to be within this INDEX AREA (D/2 x E/2)

TOP VIEW

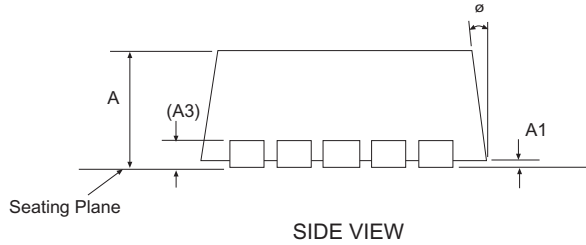

SIDE VIEW

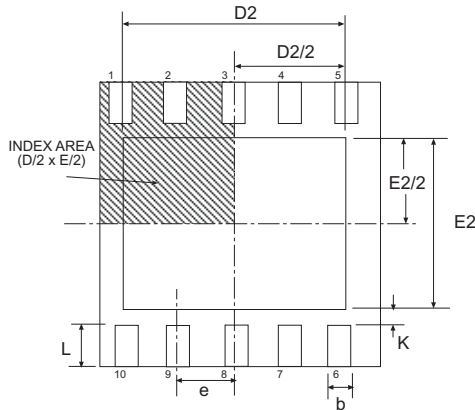

BOTTOM VIEW

3x3 10 Pin DFN		JEDEC MO-229			VARIATION VEED-5		
SYMBOL	Dimensions in Millimeters: Controlling Dimension			Dimensions in Inches Conversion Factor: 1 Inch = 25.40 mm			
	MIN	NOM	MAX	MIN	NOM	MAX	
A	0.80	0.90	1.00	0.032	0.036	0.039	
A1	0.00	0.02	0.05	0.000	0.001	0.002	
A3	0.20 REF			0.008 REF			
K	0.20	-	-	0.008	-	-	
ø	0°	-	14°	0°	-	14°	
b	0.18	0.25	0.30	0.008	0.010	0.012	
D	3.00 BSC			0.119 BSC			
D2	2.20	-	2.70	0.087	-	0.106	
E	3.00 BSC			0.119 BSC			
E2	1.40	-	1.75	0.056	-	0.069	
e	0.50 BSC			0.020 BSC			
L	0.30	0.40	0.50	0.012	0.016	0.020	
SIPEX Pkg Signoff Date/Rev:				JL Aug09-05 / RevA			

Part Number	Operating Temperature Range	Package Type
SP6685ER	-40°C to +85°C	10 Pin DFN
SP6685ER/TR	-40°C to +85°C	10 Pin DFN

Available in lead free packaging. To order add “-L” suffix to part number.

Example: SP6685ER/TR = standard; SP6685ER-L/TR = lead free

/TR = Tape and Reel

Pack quantity is 3,000 for DFN.



Sipex Corporation

**Headquarters and
Sales Office**
233 South Hillview Drive
Milpitas, CA 95035
TEL: (408) 934-7500
FAX: (408) 935-7600

Sipex Corporation reserves the right to make changes to any products described herein. Sipex does not assume any liability arising out of the application or use of any product or circuit described herein; neither does it convey any license under its patent rights nor the rights of others.