



Alcohol Gas Sensor

(Model: MQ-3)

Manual

Version: 1.3

Valid from: 2014-05-01

Zhengzhou Winsen Electronics Technology Co., Ltd

Statement

This manual copyright belongs to Zhengzhou Winsen Electronics Technology Co., LTD. Without the written permission, any part of this manual shall not be copied, translated, stored in database or retrieval system, also can't spread through electronic, copying, record ways.

Thanks for purchasing our product. In order to let customers use it better and reduce the faults caused by misuse, please read the manual carefully and operate it correctly in accordance with the instructions. If users disobey the terms or remove, disassemble, change the components inside of the sensor, we shall not be responsible for the loss.

The specific such as color, appearance, sizes &etc, please in kind prevail.

We are devoting ourselves to products development and technical innovation, so we reserve the right to improve the products without notice. Please confirm it is the valid version before using this manual. At the same time, users' comments on optimized using way are welcome.

Please keep the manual properly, in order to get help if you have questions during the usage in the future.

Zhengzhou Winsen Electronics Technology CO., LTD

MQ-3 Semiconductor Sensor for Alcohol Gas

Profile

Sensitive material of MQ-3 gas sensor is SnO₂, which with lower conductivity in clean air. When the target alcohol gas exist, the sensor's conductivity gets higher along with the gas concentration rising. Users can convert the change of conductivity to correspond output signal of gas concentration through a simple circuit.

MQ-3 gas sensor has high sensitivity to alcohol gas and can resistant to the interference of gasoline, smoke and vapour. It is with low cost and suitable for various applications of detecting alcohol at different concentration.



Features

It has good sensitivity to alcohol in wide range, and has advantages such as long lifespan, low cost and simple drive circuit &etc.

Main Applications

It is widely used in domestic alcohol gas alarm, industrial alcohol gas alarm and portable alcohol detector.

Technical Parameters Stable.1

| | | | |
|---|-----------------------|--|--|
| Model | | MQ-3 | |
| Sensor Type | | Semiconductor | |
| Standard Encapsulation | | Plastic cap | |
| Target Gas | | Alcohol gas | |
| Detection range | | 25~500ppm alcohol | |
| Standard Circuit Conditions | Loop Voltage | V _c | ≤24V DC |
| | Heater Voltage | V _H | 5.0V±0.1V AC or DC |
| | Load Resistance | R _L | Adjustable |
| Sensor character under standard test conditions | Heater Resistance | R _H | 29Ω±3Ω (room tem.) |
| | Heater consumption | P _H | ≤900mW |
| | Sensitivity | S | R _o (in air)/R _s (125ppm C ₂ H ₅ OH)≥5 |
| | Output Voltage | V _s | 2.5V~4.0V (in 125ppm C ₂ H ₅ OH) |
| | Concentration Slope | α | ≤0.6(R _{300ppm} /R _{50ppm} C ₂ H ₅ OH) |
| Standard test conditions | Tem. Humidity | 20°C±2°C; 55%±5%RH | |
| | Standard test circuit | V _c :5.0V±0.1V V _H :5.0V±0.1V | |
| | Preheat time | Over 48 hours | |

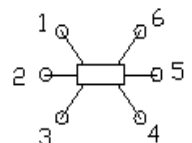
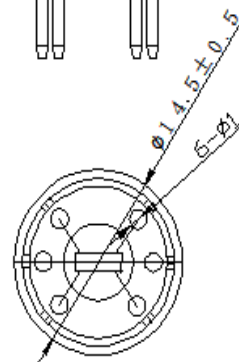
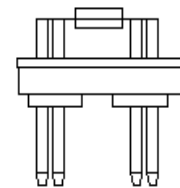
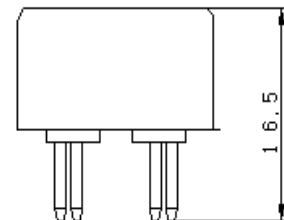

NOTE: Output voltage (V_s) is V_{RL} in test environment.

Fig1.Sensor Structure

Unit: mm

Basic Circuit

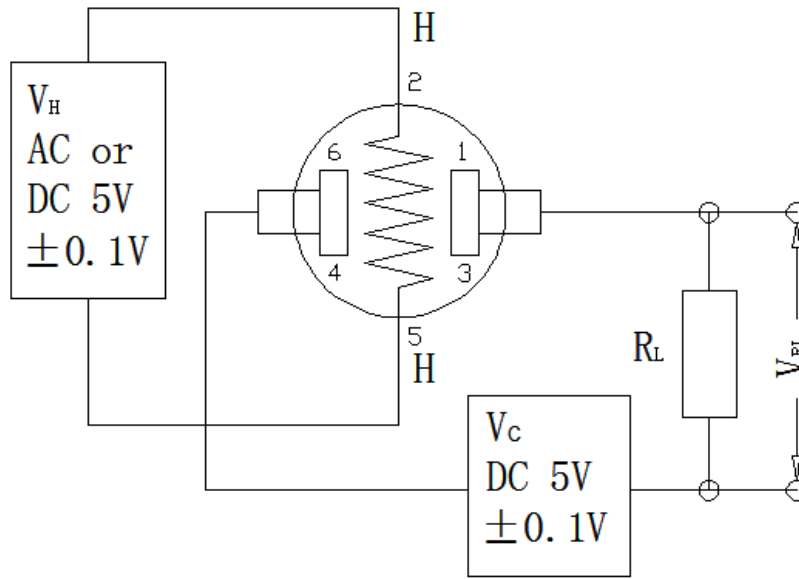

Fig2. MQ-3 Test Circuit

Instructions: The above fig is the basic test circuit of MQ-3. The sensor requires two voltage inputs: heater voltage (V_H) and circuit voltage (V_C). V_H is used to supply standard working temperature to the sensor and it can adopt DC or AC power, while V_{RL} is the voltage of load resistance R_L which is in series with sensor. V_C supplies the detect voltage to load resistance R_L and it should adopt DC power.

Description of Sensor Characters

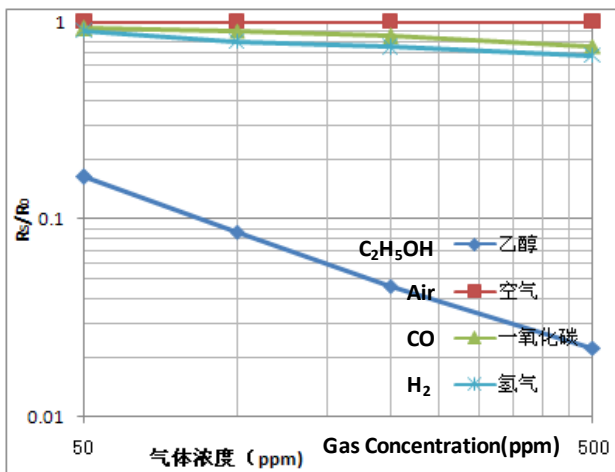

Fig3. Typical Sensitivity Curve

The ordinate is resistance ratio of the sensor (R_s/R_0), the abscissa is concentration of gases. R_s means resistance in target gas with different concentration, R_0 means resistance of sensor in dean air. All tests are finished under standard test conditions.

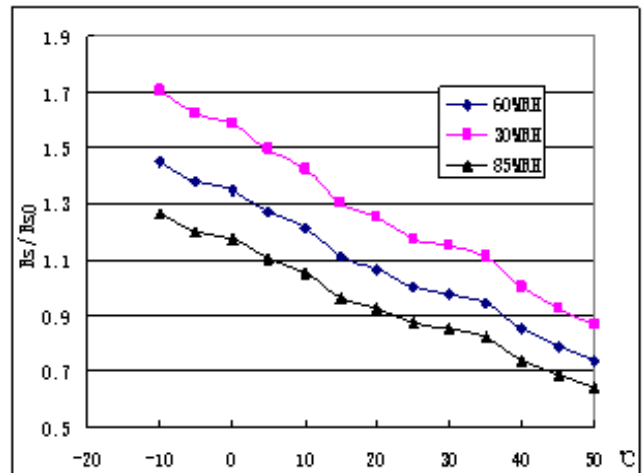

Fig4. Typical temperature/humidity characteristics

The ordinate is resistance ratio of the sensor (R_s/R_{s0}). R_s means resistance of sensor in 125ppm alcohol (C_2H_5OH) under different tem. and humidity. R_{s0} means resistance of the sensor in 125 alcohol (C_2H_5OH) under 20°C/55%RH.

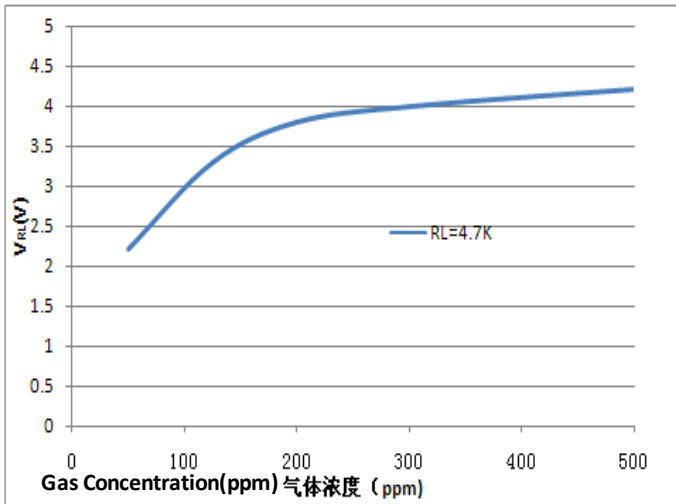

Fig5.Sensitivity Curve

Fig5 shows the V_{RL} in alcohol with different concentration. The resistance load R_L is 4.7 K Ω and the test is finished in standard test conditions.

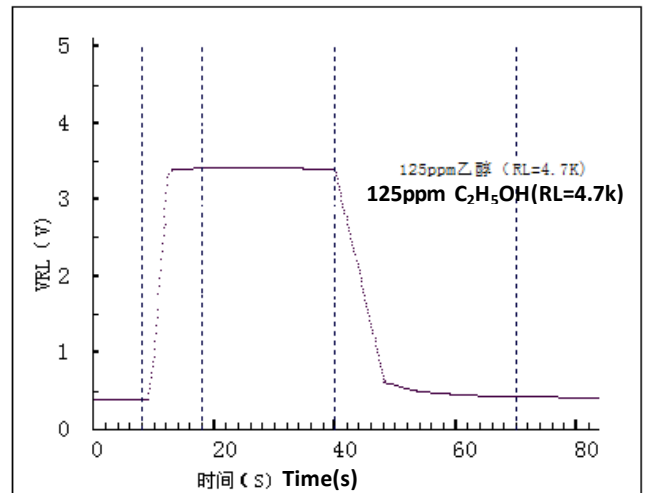

Fig6.Response and Resume

Fig5 shows the changing of V_{RL} in the process of putting the sensor into target gas and removing it out.

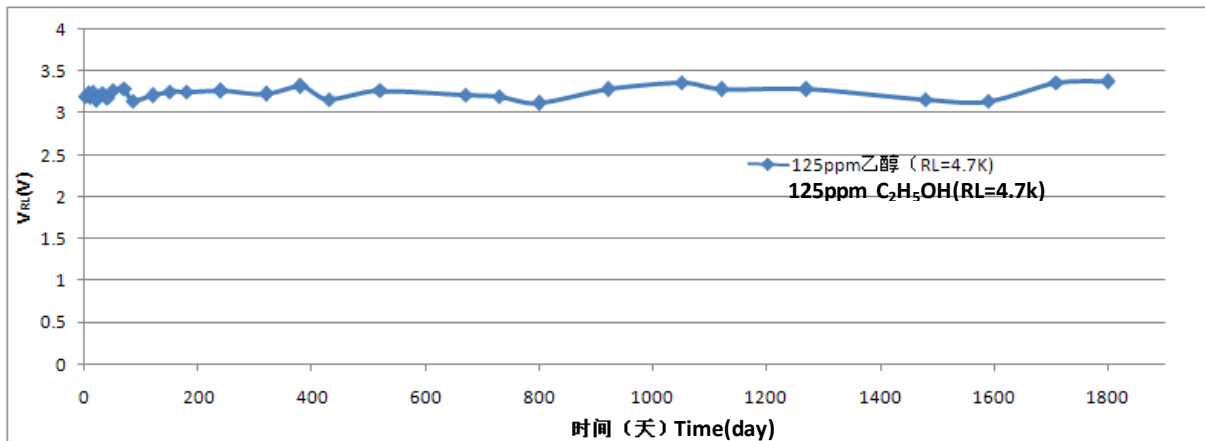

Fig6.long-term Stability

Test is finished in standard test conditions, the abscissa is observing time and the ordinate is V_{RL} .

Cautions

1.Following conditions must be prohibited

1.1 Exposed to organic silicon steam

Sensing material will lose sensitivity and never recover if the sensor absorbs organic silicon steam. Sensors must avoid exposing to silicon bond, fixture, silicon latex, putty or plastic contain silicon environment.

1.2 High Corrosive gas

If the sensors are exposed to high concentration corrosive gas (such as H_2S , SO_x , Cl_2 , HCl etc.), it will not only result in corrosion of sensors structure, also it cause sincere sensitivity attenuation.

1.3 Alkali, Alkali metals salt, halogen pollution

The sensors performance will be changed badly if sensors be sprayed polluted by alkali metals salt especially brine, or be exposed to halogen such as fluorine.

1.4 Touch water

Sensitivity of the sensors will be reduced when spattered or dipped in water.

1.5 Freezing

Do avoid icing on sensor's surface, otherwise sensing material will be broken and lost sensitivity.

1.6 Applied higher voltage

Applied voltage on sensor should not be higher than stipulated value, even if the sensor is not physically damaged or broken, it causes down-line or heater damaged, and bring on sensors' sensitivity characteristic changed badly.

1.7 Voltage on wrong pins

For 6 pins sensor, Pin 2&5 is heating electrodes, Pin (1,3)/(4,6) are testing electrodes (Pin 1 connects with Pin 3, while Pin 4 connects with Pin 6).If apply voltage on Pin 1&3 or 4&6, it will make lead broken; and no signal putout if apply on pins 2&4.

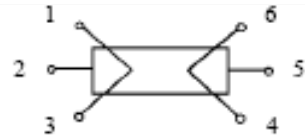

Fig8. Lead sketch

2 .Following conditions must be avoided

2.1 Water Condensation

Indoor conditions, slight water condensation will influence sensors' performance lightly. However, if water condensation on sensors surface and keep a certain period, sensors' sensitive will be decreased.

2.2 Used in high gas concentration

No matter the sensor is electrified or not, if it is placed in high gas concentration for long time, sensors characteristic will be affected. If lighter gas sprays the sensor, it will cause extremely damage.

2.3 Long time storage

The sensors resistance will drift reversibly if it's stored for long time without electrify, this drift is related with storage conditions. Sensors should be stored in airproof bag without volatile silicon compound. For the sensors with long time storage but no electrify, they need long galvanical aging time for stability before using. The suggested aging time as follow:

Stable2.

| Storage Time | Suggested aging time |
|----------------------|------------------------|
| Less than one month | No less than 48 hours |
| 1 ~ 6 months | No less than 72 hours |
| More than six months | No less than 168 hours |

2.4 Long time exposed to adverse environment

No matter the sensors electrified or not, if exposed to adverse environment for long time, such as high humidity, high temperature, or high pollution etc., it will influence the sensors' performance badly.

2.5 Vibration

Continual vibration will result in sensors down-lead response then break. In transportation or assembling line, pneumatic screwdriver/ultrasonic welding machine can lead this vibration.

2.6 Concussion

If sensors meet strong concussion, it may lead its lead wire disconnected.

2.7 Usage Conditions

2.7.1For sensor, handmade welding is optimal way. The welding conditions as follow:

- Soldering flux: Rosin soldering flux contains least chlorine
- homothermal soldering iron

- Temperature: 250°C
 - Time: less than 3 seconds
- 2.7.1 If users choose wave-soldering, the following conditions should be obey:
- Soldering flux: Rosin soldering flux contains least chlorine
 - Speed: 1-2 Meter/Minute
 - Warm-up temperature: 100±20°C
 - Welding temperature: 250±10°C
 - One time pass wave crest welding machine
- If disobey the above using terms, sensors sensitivity will be reduced.

Zhengzhou Winsen Electronics Technology Co., Ltd

Add: No.299, Jinsuo Road, National Hi-Tech Zone,
Zhengzhou 450001 China

Tel: +86-371-67169097/67169670

Fax: +86-371-60932988

E-mail: sales@winsensor.com

Website: www.winsensor.com