

## 2-in-1 White Ultima

**Part No:**  
MA111.W.C.LB.001

### **Description:**

MA111 White Ultima Series – 2-in-1 Super Low-Profile Combination GPS/GLONASS/BeiDou/Galileo and Cellular Permanent Mount Antenna

### **Features:**

Height: 19.6mm (0.77")  
Diameter: 55mm (2.17")  
Heavy duty Permanent Mount  
UV and vandal resistant White ABS housing and thread  
IP67 Rated Waterproof  
Cable: 3m RG-174 GNSS, 3m CFD-200 Cellular  
Connector: SMA(M)ST  
RoHS & Reach Compliant

1. Introduction	3
2. Specifications	4
3. Antenna Characteristics	8
4. Active Antenna Characteristics	13
5. Radiation Patterns	17
6. Mechanical Drawing	39
7. Installation	40
8. Packaging	41
9. Application Note	42
<hr/>	
Changelog	45

Taoglas makes no warranties based on the accuracy or completeness of the contents of this document and reserves the right to make changes to specifications and product descriptions at any time without notice. Taoglas reserves all rights to this document and the information contained herein. Reproduction, use or disclosure to third parties without express permission is strictly prohibited.



# 1. Introduction



The MA111.W Ultima Series 2-in-1 GPS/GLONASS/BeiDou/Galileo & Cellular Combination Antenna is an extremely low-profile combination high performance GPS/GLONASS/BeiDou/Galileo and cellular antenna solution for professional telematics applications. At only 22 mm height it is one of the lowest profile antennas in the market, with a diameter of 55 mm. It is designed to be mounted and couple to the metal structures it attaches to radiate. Durable UV ABS housing, thread and nut is resistant to vandalism and direct attack.

Typical Applications Include:

- Asset Tracking
- Digital Signage
- Smart Metering

The IP67 waterproof robust plastic body makes it extremely light, economical for shipping and minimum weight impact on vehicles. This also makes it ideal for use in humid environments such as water pits or marine applications as there are no external metal parts to corrode. The closed cell foam with double-sided adhesive provides a permanent waterproof seal and can adjust to different curvatures, stopping water from leaking under the antenna into the mounting hole.

For applications that require mounting on non-metal structures we recommend the Hercules MA105. The cables and connectors are fully customizable, contact your regional Taoglas Customer support teams for more information.

## 2. Specifications

GNSS Frequency Bands Covered							
GPS/QZSS	L1	L2	L5	L6			
	1575.42MHz	1227.6MHz	1176.45MHz	1278.75MHz			
	■	□	□	□			
GLONASS	L5R	L3PT	L2PT	L1CR	L1PT		
	1176.45MHz	1201.5MHz	1246MHz	1575.42MHz	1602MHz		
	□	□	□	■	■		
Galileo	E5a	E5b	E4	E3	E6	E2	L1
	1176.45MHz	1201.5MHz	1215MHz	1256MHz	1278.75MHz	1561MHz	1575.42MHz
	□	□	□	□	□	■	■
BeiDou	B1	B2	B3				
	1561MHz	1207.14MHz	1268.52MHz				
	■	□	□				
Compass	E5B(B2)/ E6(B3)	E2(B1)					
	1268.56MHz	1561MHz					
	□	■					
SBAS	Omnistar	WAAS/EGN OS					
	1542.5MHz	1575.42MHz					
	□	■					

GNSS Electrical			
Frequency (MHz)	1561	1575.42	1602
Efficiency (%)			
Free space	48.3	56.2	42.6
30x30cm Ground plane	44.7	55.7	61.5
Average Gain (dB)			
Free space	-3.16	-2.50	-3.71
30x30cm Ground plane	-3.49	-2.54	-2.11
Peak Gain (dBi)			
Free space	1.08	1.88	1.05
30x30cm Ground plane	1.32	2.56	4.13
Polarization	RHCP		
Impedance	50Ω		
Return Loss	<-10dB		

LNA and Filter Electrical Properties			
Frequency (MHz)	1561	1575.42	1602
Gain@1.8V (Typ.)	22.23dB	21.65dB	18.85dB
Gain@3.0V (Typ.)	30.11dB	32.39dB	28.37dB
Gain@5.5V (Typ.)	34.87dB	39.07dB	33.09dB
Noise@1.8V (Typ.)	1.83dB	1.85dB	1.99dB
Noise@3.0V (Typ.)	1.5dB	1.49dB	1.5dB
Noise@5.5V (Typ.)	1.66dB	1.61dB	1.62dB
Current@1.8V(mA)	4.88mA		
Current@3.0V(mA)	10.84mA		
Current@5.5V(mA)	22.83mA		

Cellular Antenna											
Frequency (MHz)	5G NR Band 71		LTE700	GSM 850/900	5G NR Band	DCS	PCS	UMTS1	LTE2600	5G NR Band 77, 78, 79	LTE5200/Wi-Fi 5800
	617 ~698	698 ~806	824 ~960	1427 ~1518	1710 ~1880	1850 ~1990	1920 ~2170	2490 ~2690	3300 ~3500	5150 ~5925	
Efficiency (%)											
Free Space	3m	9.6	10.9	21.2	13.0	49.9	47.9	40.7	14.8	28.6	26.9
30x30cm Ground Plane	3m	2.0	29.3	51.0	10.1	36.6	37.4	29.2	11.7	25.5	20.4
Average Gain (dB)											
Free Space	3m	-10.18	-9.63	-6.73	-8.87	-3.02	-3.20	-3.90	-8.29	-5.44	-5.70
30x30cm Ground Plane	3m	-16.91	-5.33	-2.92	-9.95	-4.36	-4.27	-5.35	-9.34	-5.94	-6.91
Peak Gain (dBi)											
Free Space	3m	-5.83	-5.41	-1.66	-3.70	2.20	2.40	1.56	-3.06	1.10	-0.44
30x30cm Ground Plane	3m	-10.81	-0.09	2.93	-1.42	2.73	4.01	3.33	-2.18	0.60	0.11
Impedance	50Ω										
Polarization	Linear										
Radiation Pattern	Omni-Directional										

<b>Mechanical</b>	
<b>Dimensions</b>	Diameter: 55mm, Height: 30mm
<b>Cable type</b>	Cellular: CFD-200 GPS/GLONASS/BeiDou/Galileo: RG-174
<b>Cable length</b>	3000mm
<b>Casing</b>	ABS
<b>Connector</b>	SMA Male
<b>Thread Diameter</b>	M24
<b>Weight</b>	0.21Kg
<b>Environmental</b>	
<b>Temperature Range</b>	-40°C to 85°C
<b>Waterproof</b>	IP67
<b>Thermal Shock</b>	100 cycles -40°C to +80°C
<b>Shock (drop test)</b>	1m drop on concrete 6 axes
<b>Humidity</b>	Non-condensing 65°C 95% RH

5G/4G Bands			
Band Number	5G NR / FR1 / LTE / LTE-Advanced / WCDMA / HSPA / HSPA+ / TD-SCDMA		
	Uplink	Downlink	Covered
1	UL: 1920 to 1980	DL: 2110 to 2170	✓
2	UL: 1850 to 1910	DL: 1930 to 1990	✓
3	UL: 1710 to 1785	DL: 1805 to 1880	✓
4	UL: 1710 to 1755	DL: 2110 to 2155	✓
5	UL: 824 to 849	DL: 869 to 894	✓
7	UL: 2500 to 2570	DL: 2620 to 2690	✗
8	UL: 880 to 915	DL: 925 to 960	✓
9	UL: 1749.9 to 1784.9	DL: 1844.9 to 1879.9	✓
11	UL: 1427.9 to 1447.9	DL: 1475.9 to 1495.9	✗
12	UL: 699 to 716	DL: 729 to 746	✓
13	UL: 777 to 787	DL: 746 to 756	✓
14	UL: 788 to 798	DL: 758 to 768	✓
17	UL: 704 to 716	DL: 734 to 746	✓
18	UL: 815 to 830	DL: 860 to 875	✓
19	UL: 830 to 845	DL: 875 to 890	✓
20	UL: 832 to 862	DL: 791 to 821	✓
21	UL: 1447.9 to 1462.9	DL: 1495.9 to 1510.9	✗
22	UL: 3410 to 3490	DL: 3510 to 3590	✗
23	UL: 2000 to 2020	DL: 2180 to 2200	✓
24	UL: 1625.5 to 1660.5	DL: 1525 to 1559	✓
25	UL: 1850 to 1915	DL: 1930 to 1995	✓
26	UL: 814 to 849	DL: 859 to 894	✓
27	UL: 807 to 824	DL: 852 to 869	✓
28	UL: 703 to 748	DL: 758 to 803	✓
29	UL: -	DL: 717 to 728	✓
30	UL: 2305 to 2315	DL: 2350 to 2360	✓
31	UL: 452.5 to 457.5	DL: 462.5 to 467.5	✗
32	UL: -	DL: 1452 - 1496	✗
35		1850 to 1910	✓
38		2570 to 2620	✓
39		1880 to 1920	✓
40		2300 to 2400	✓
41		2496 to 2690	✓
42		3400 to 3600	✓
43		3600 to 3800	✓
48		3550 to 3700	✓
66	UL: 1710-1780	DL: 2110-2200	✓
71		617 to 698	✗
74/75/76		1427 to 1518	✗
78		3300 to 3800	✓
79		4400 to 5000	✓

\*Tested on 30\*30cm Ground Plane

\*\*Covered bands represent greater than 20% Efficiency

### 3. Antenna Characteristics

#### 3.1 Return Loss – GNSS

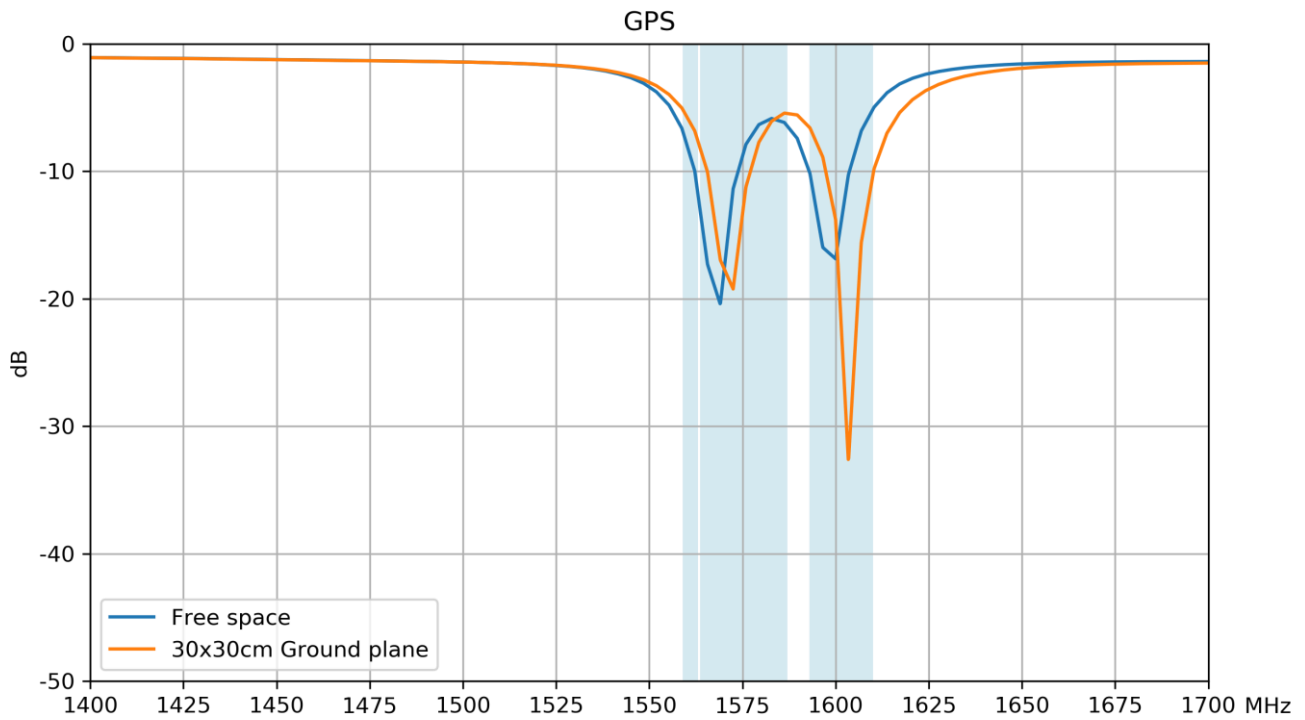

#### 3.2 Return Loss – Cellular

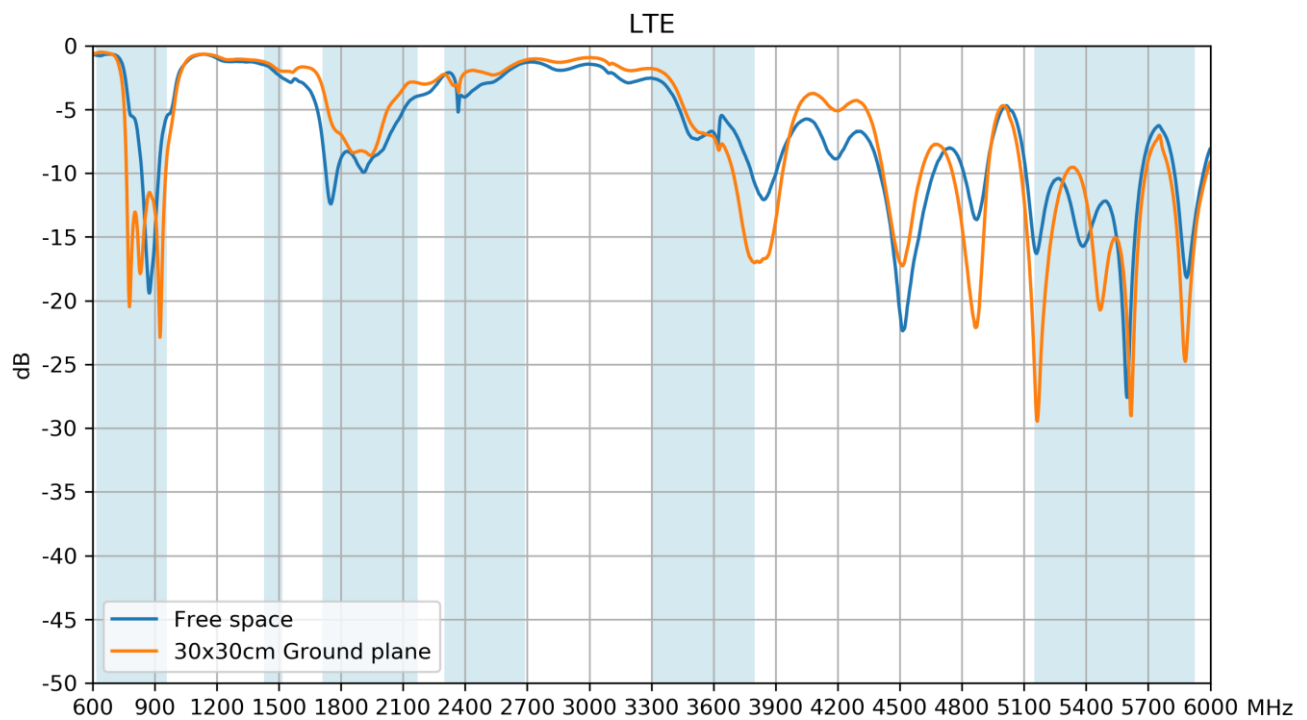



### 3.3 Efficiency – GNSS

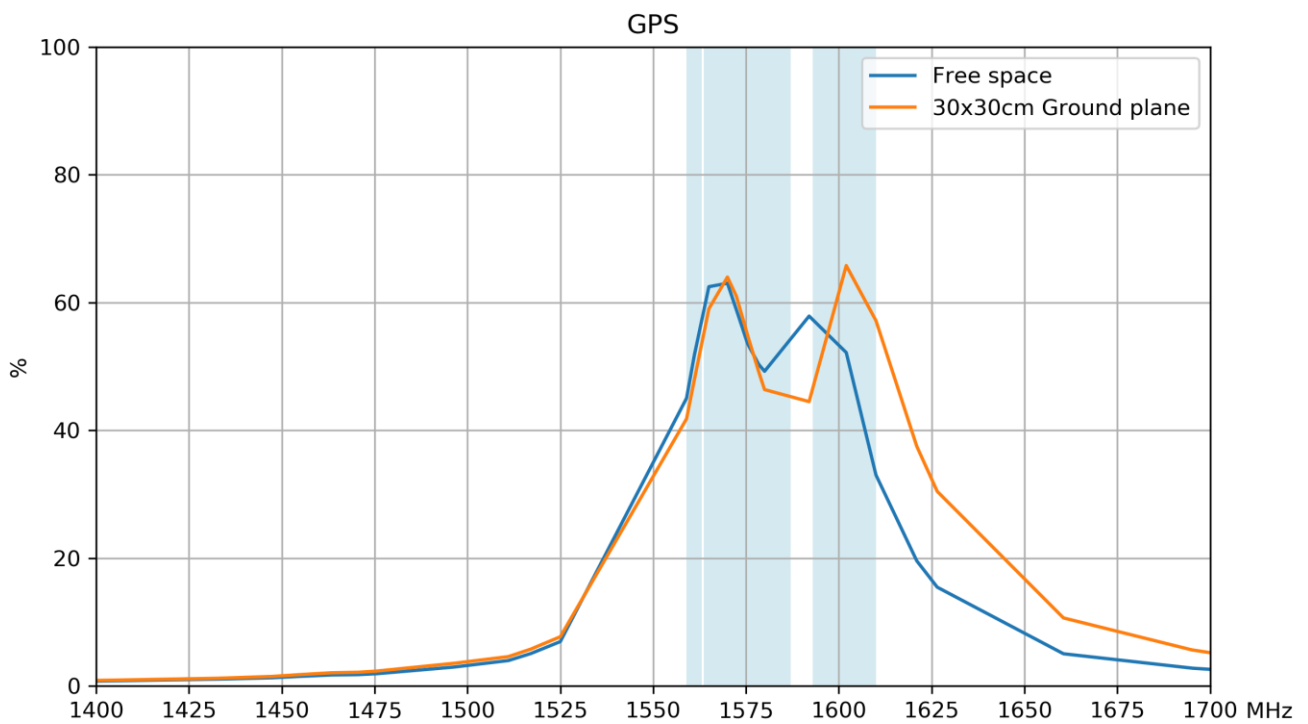

### 3.4 Efficiency – Cellular

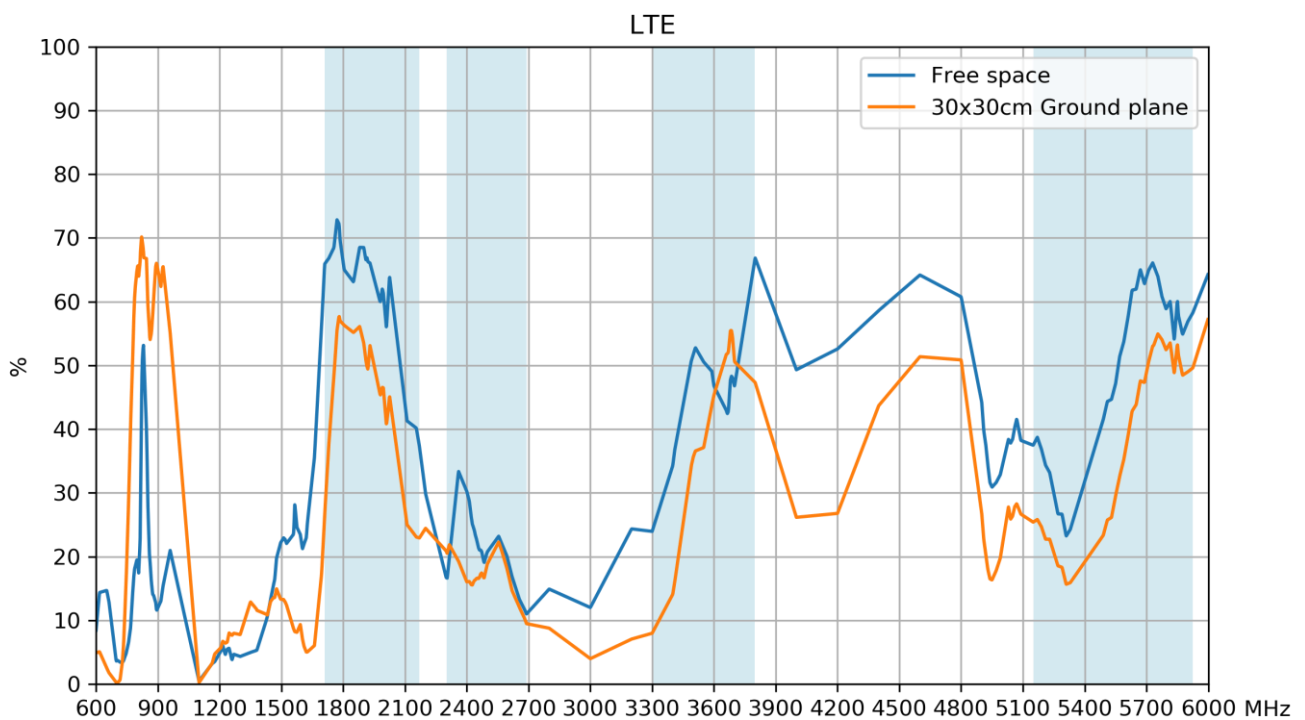

### 3.5 Average Gain – GNSS

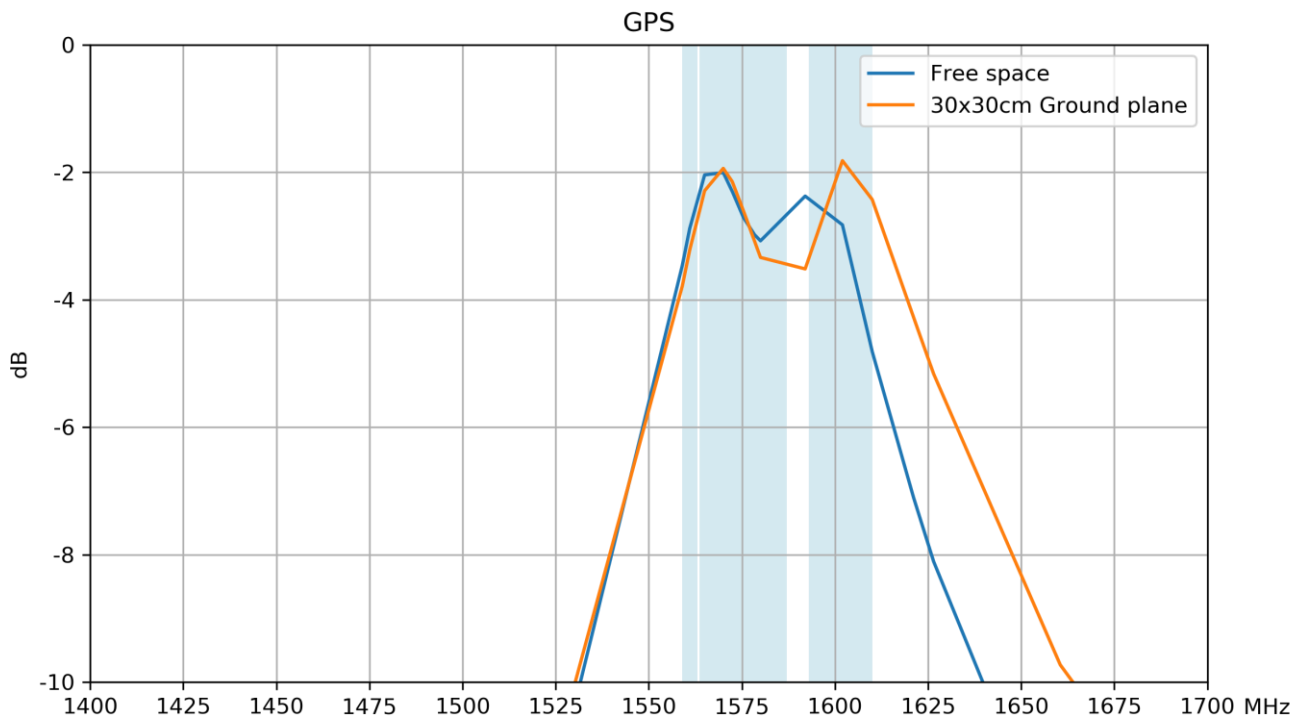

### 3.6 Average Gain – Cellular

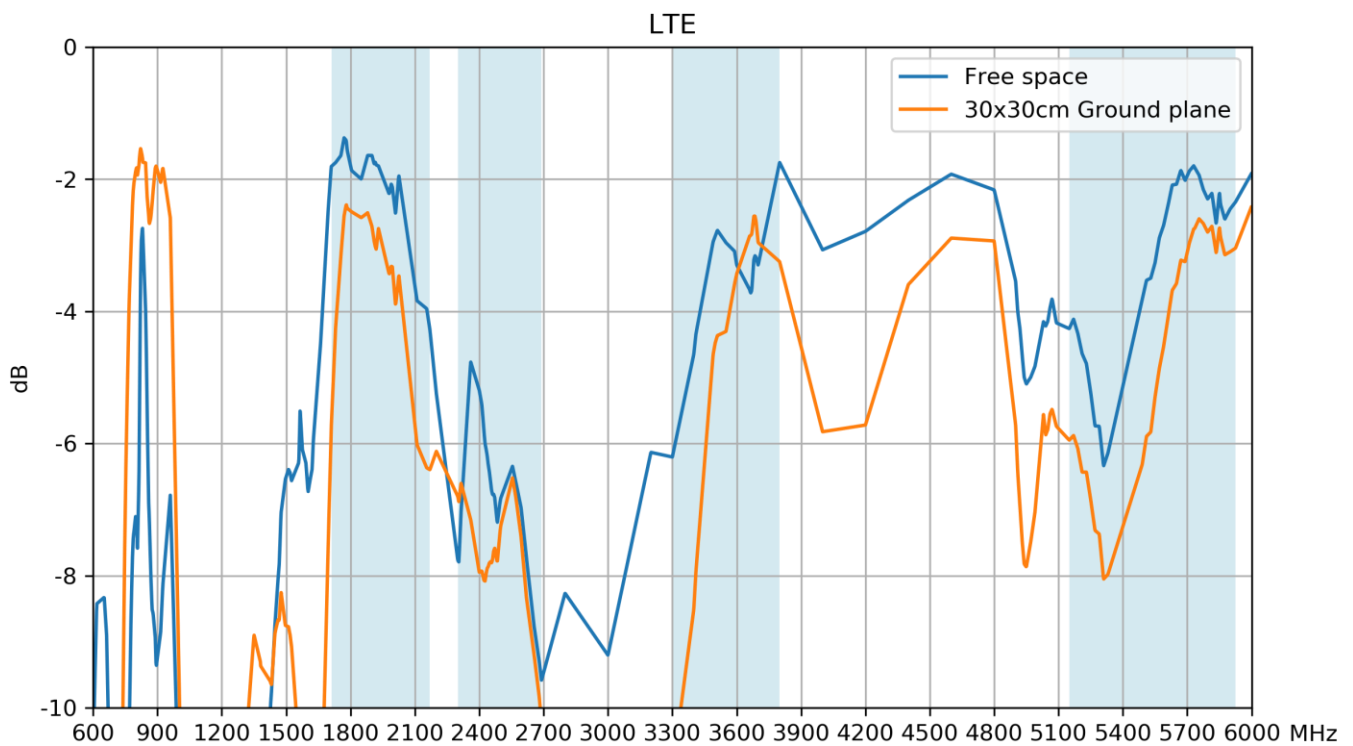

### 3.7 Peak Gain – GNSS

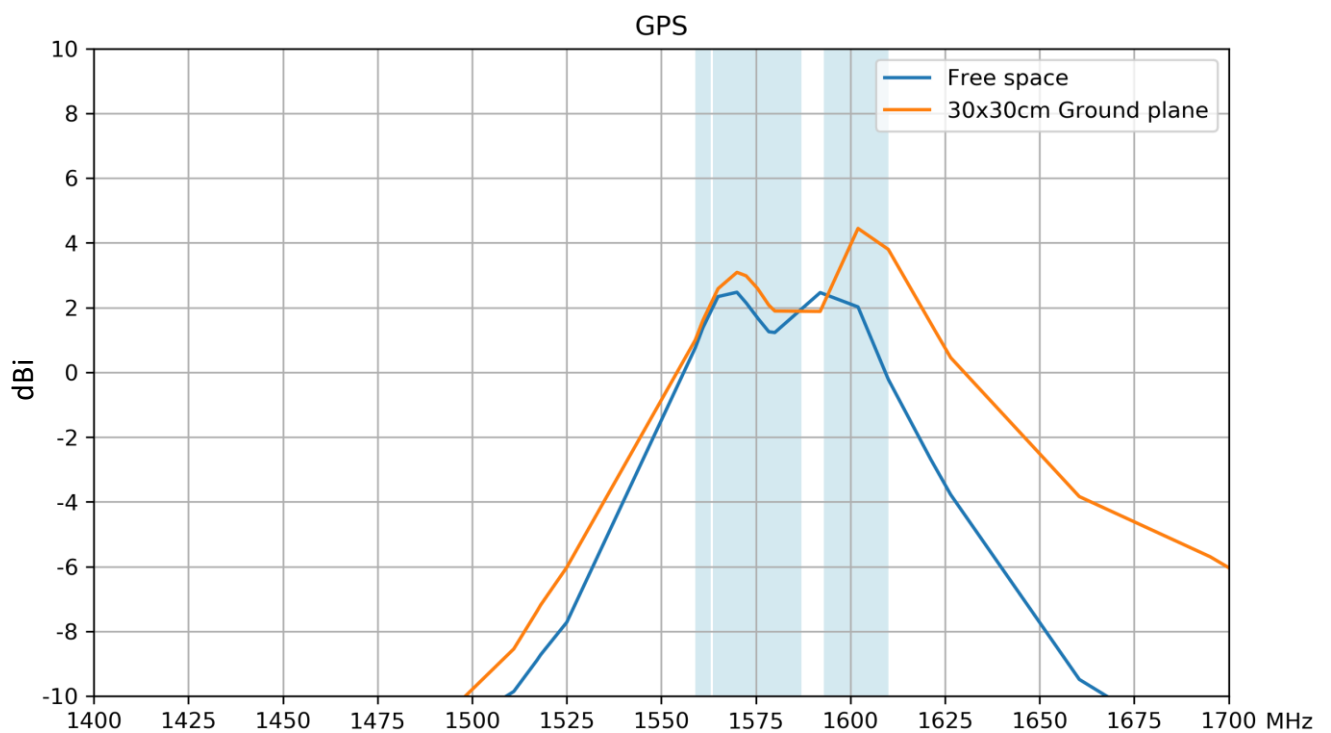

### 3.8 Peak Gain – Cellular

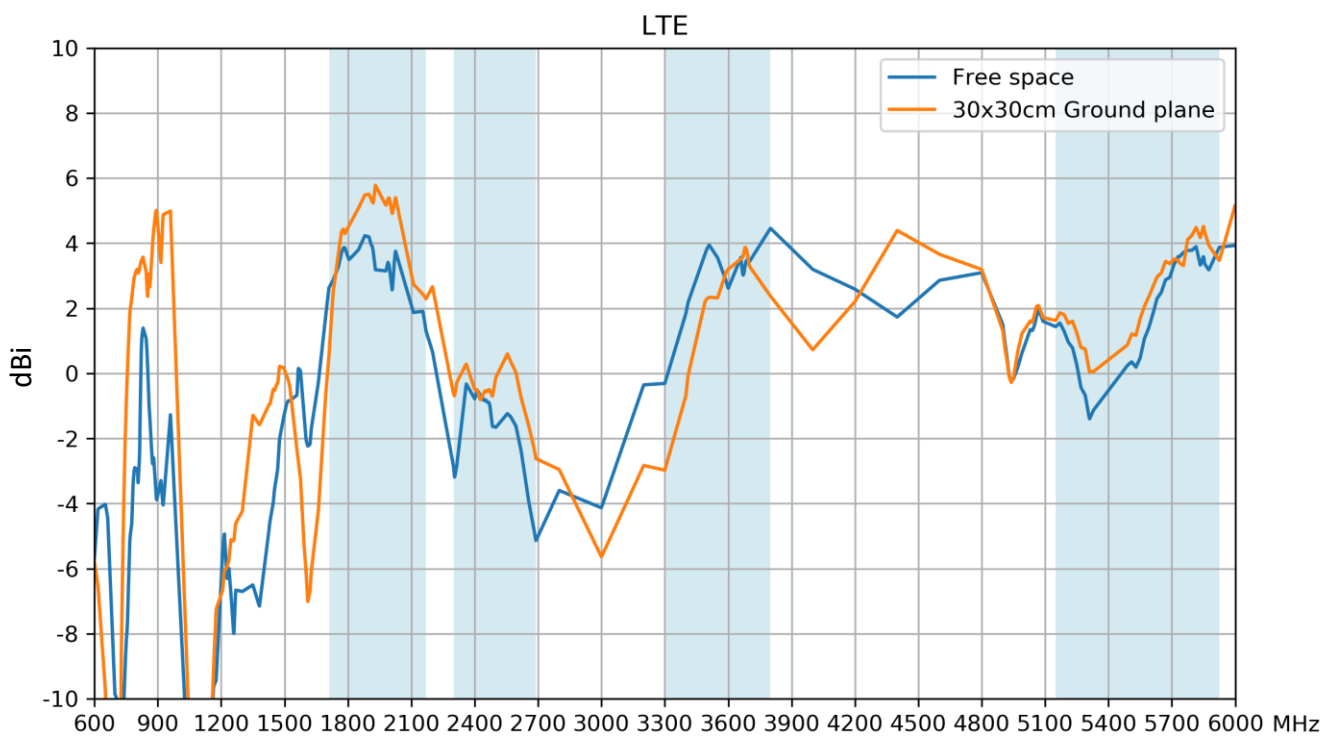

3.9 Isolation

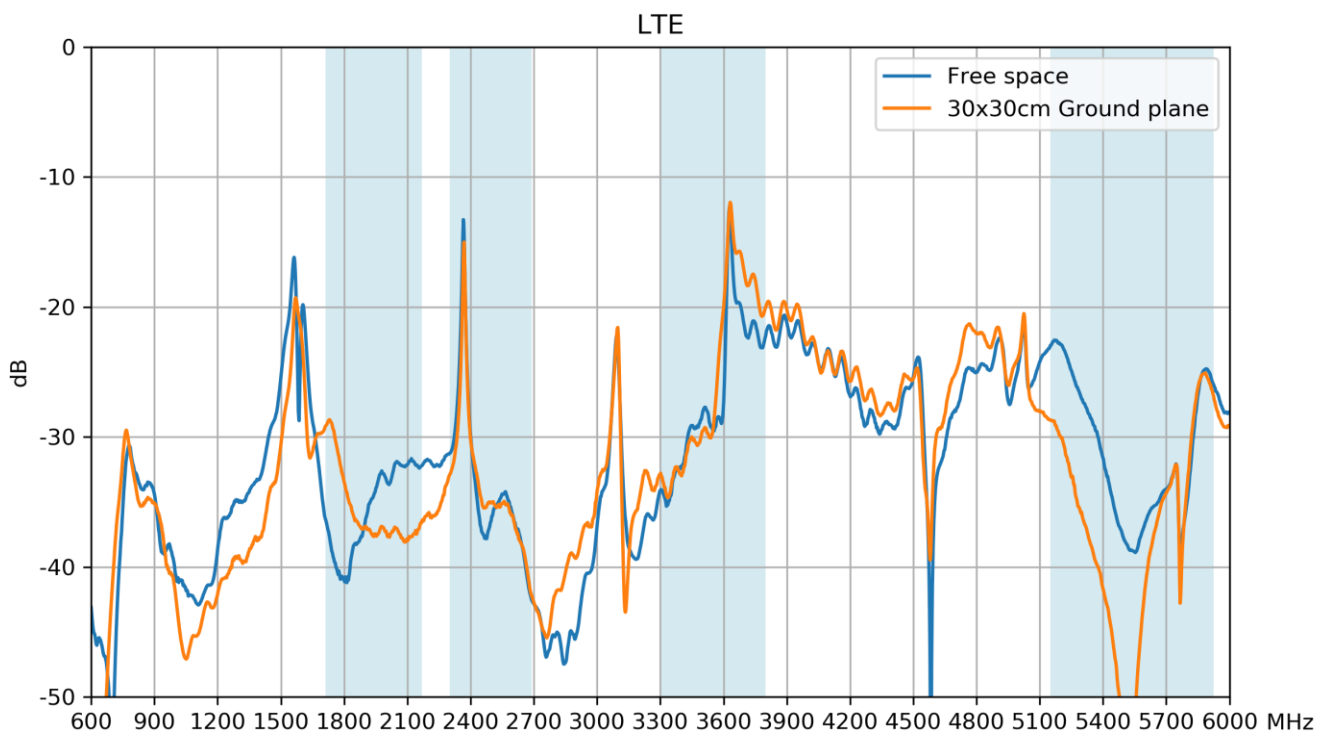

## 4. Active Antenna Characteristics

### 4.1 Block Diagram

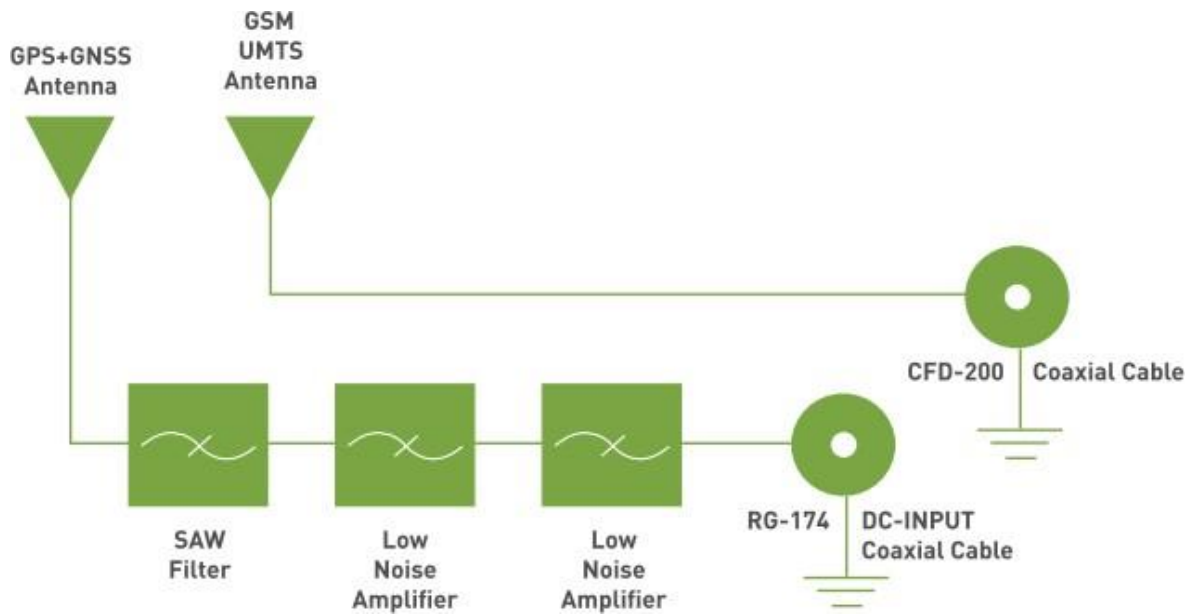

## 4.2 Block Diagram

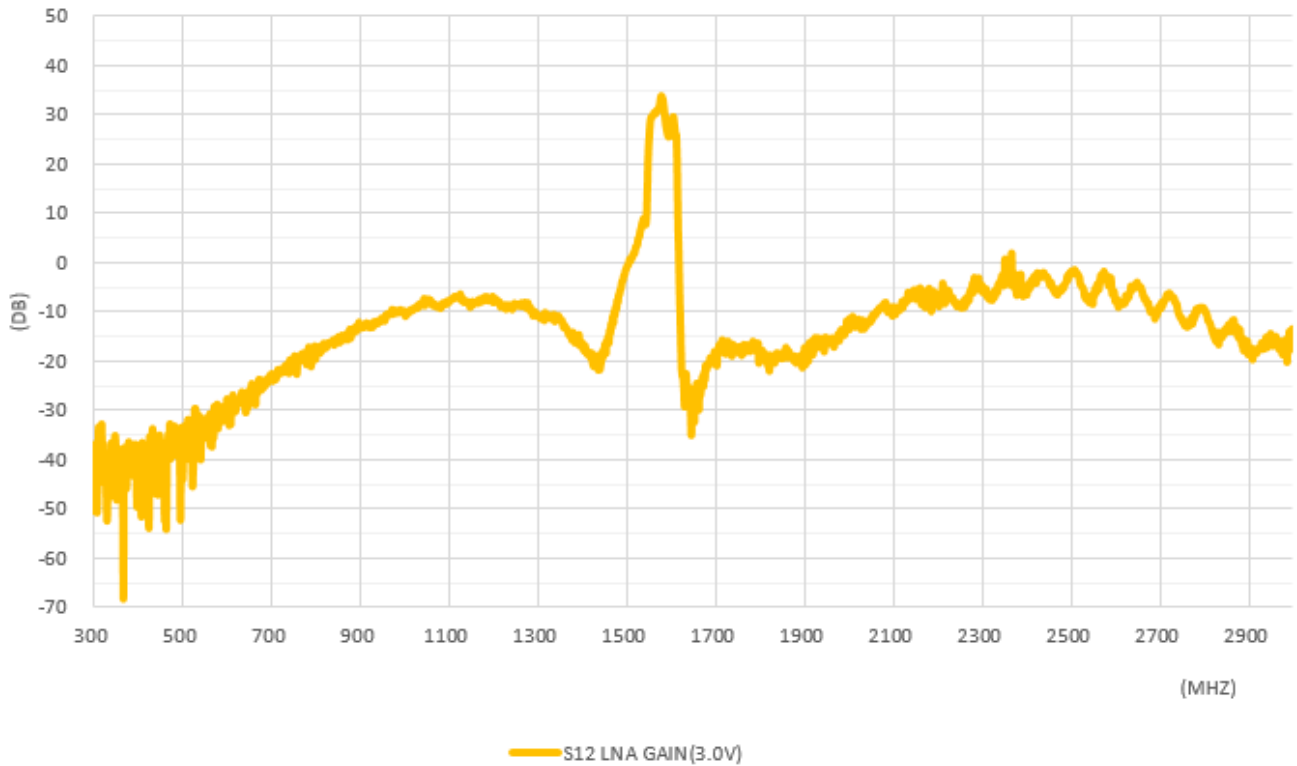

## 4.3 LNA Gain and Noise Figure @ 3.0V

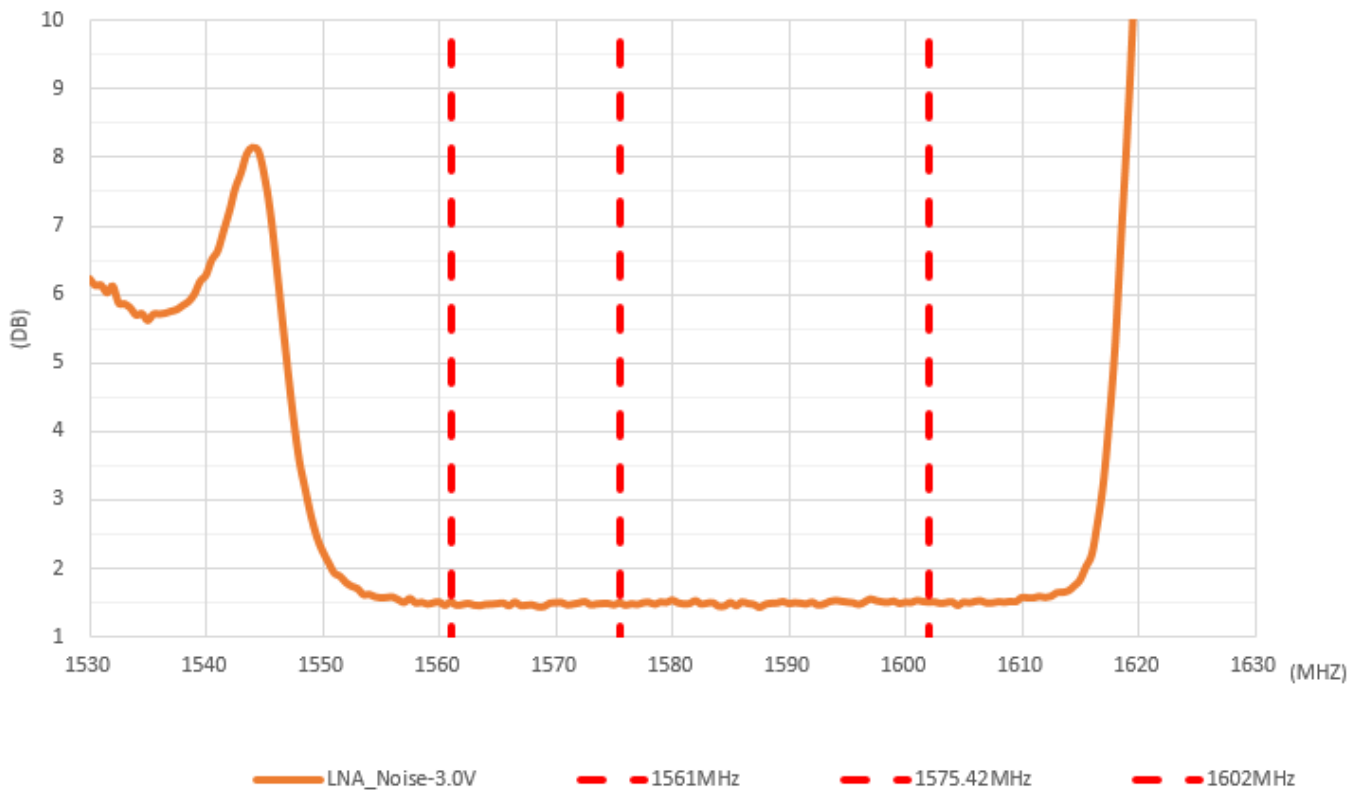

#### 4.4 Axial Ratio – BeiDou

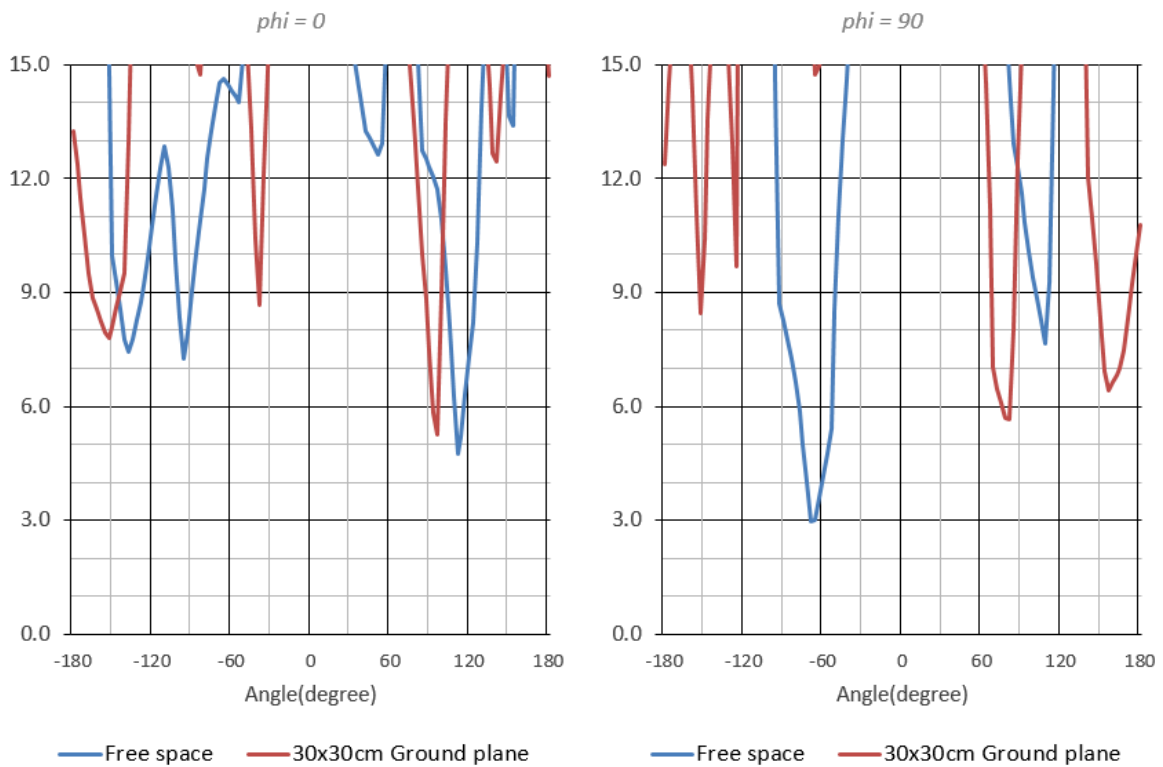

#### 4.5 Axial Ratio – GPS/Galileo

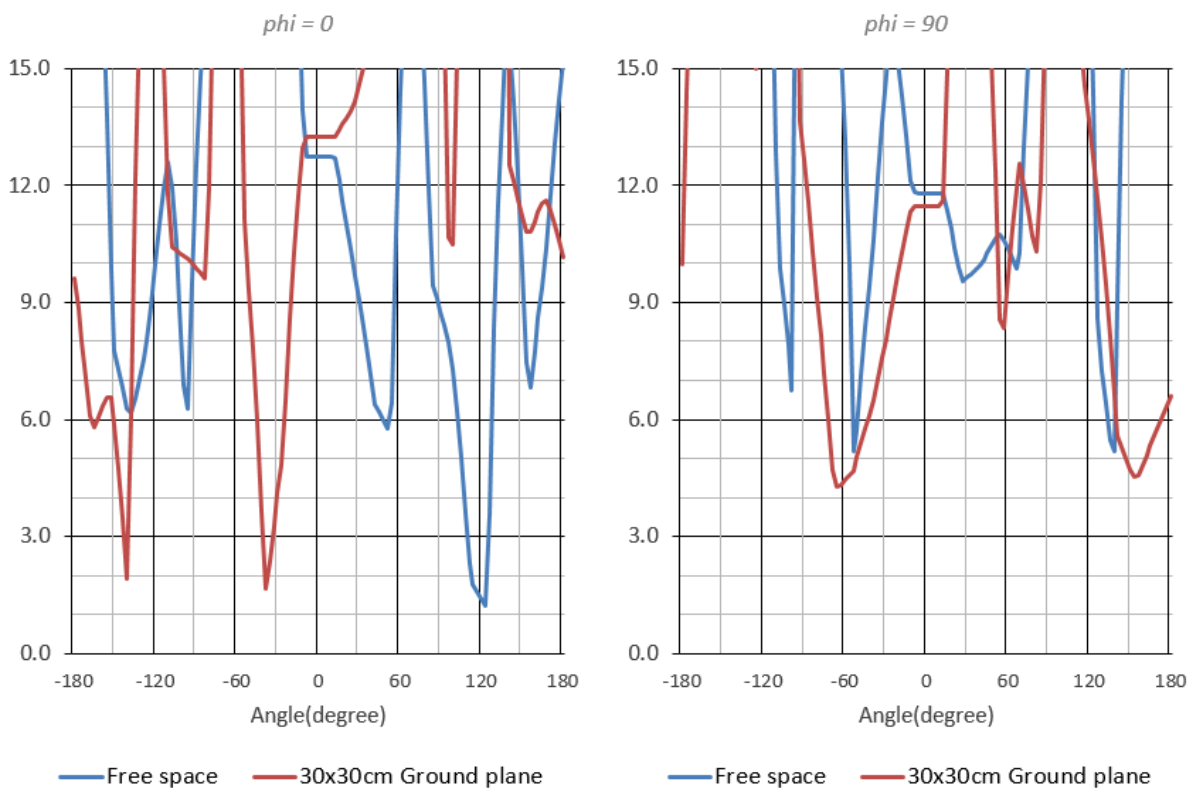

## 4.6 Axial Ratio – GLONASS

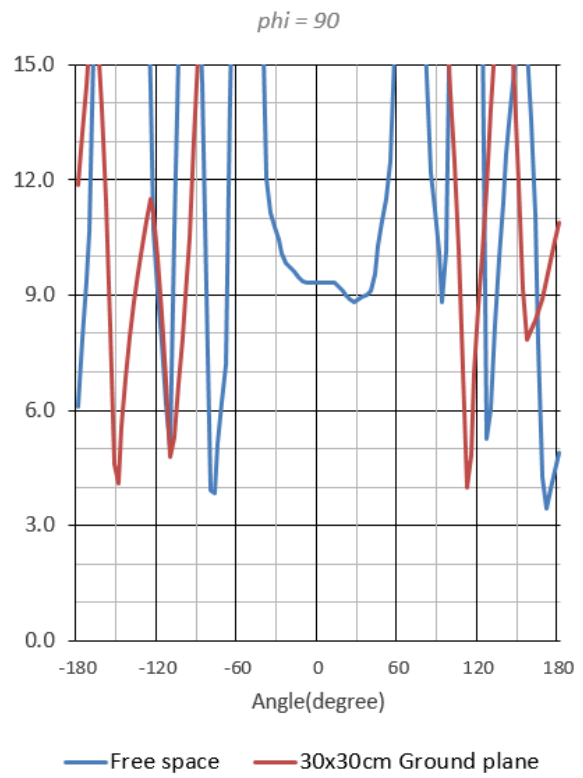
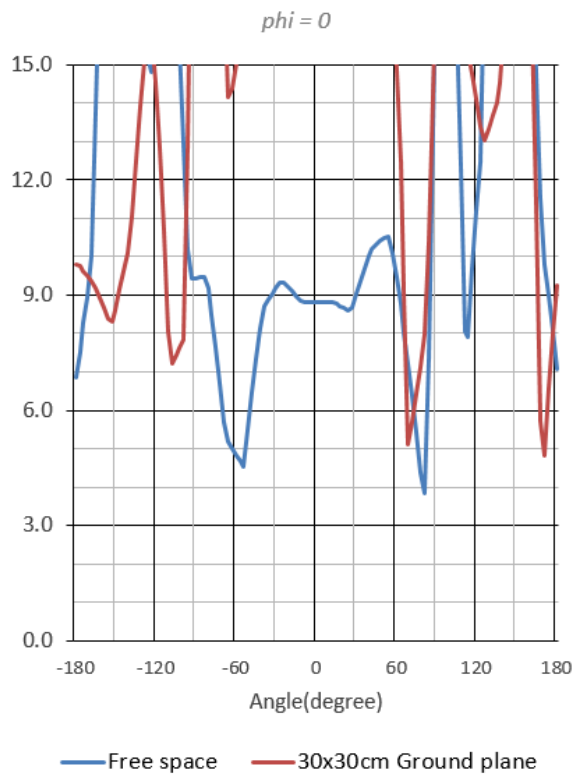



## 5. Radiation Patterns

### 5.1 Test Setup – 30\*30cm Ground Plane

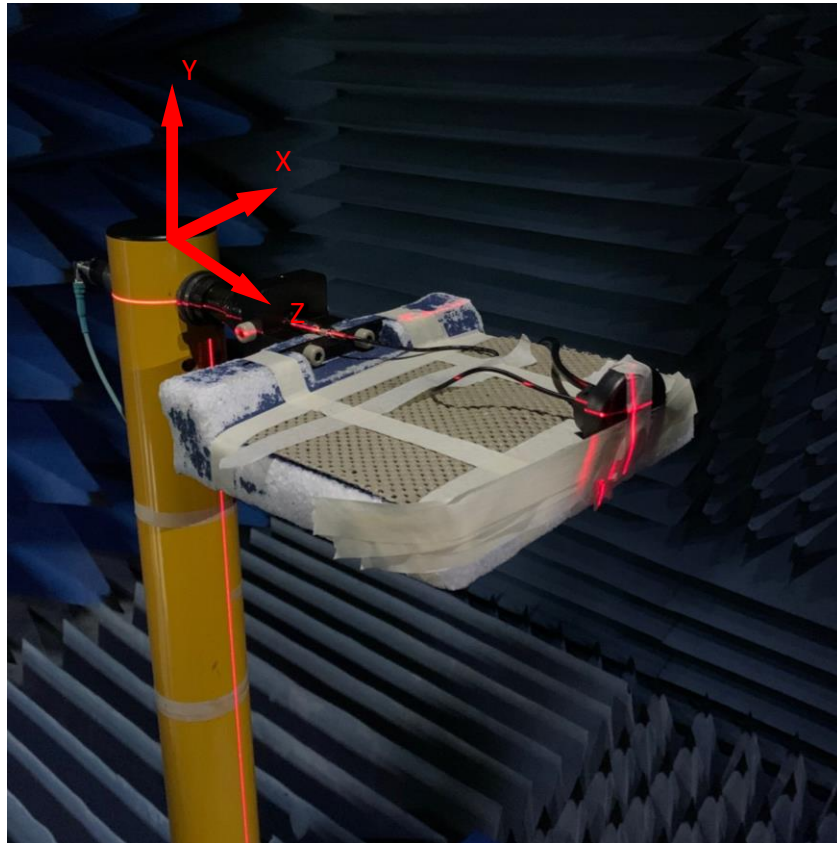

5.2 GNSS 3D and 2D Radiation Patterns – 30\*30cm Ground Plane

1561MHz

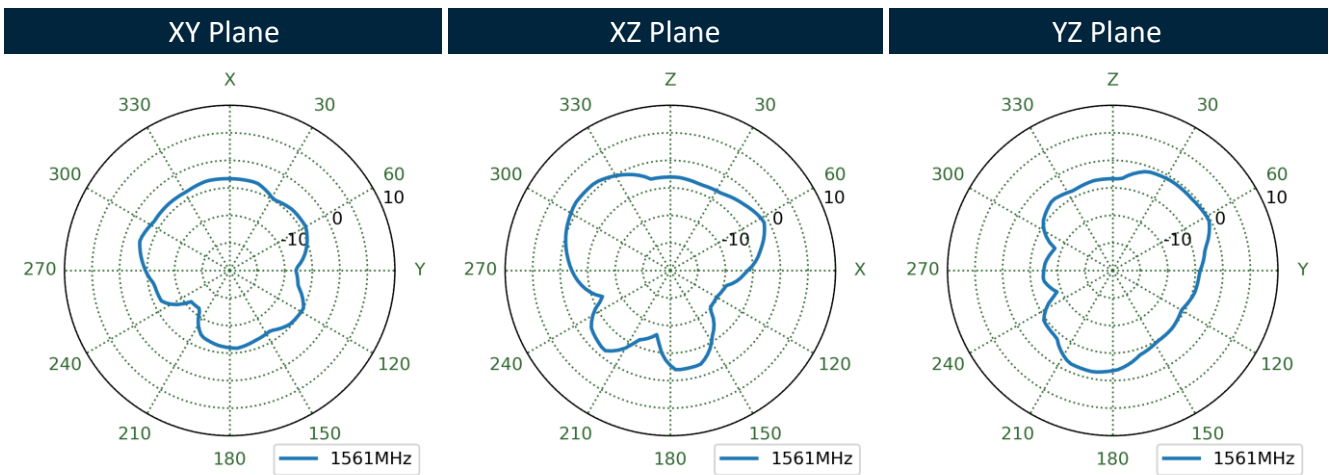
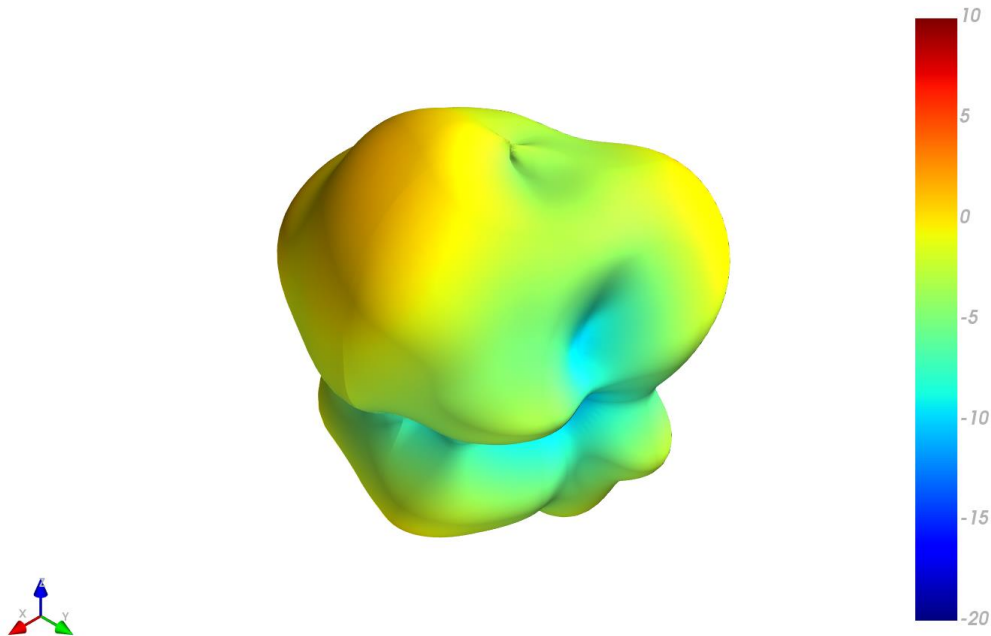

1575.42MHz

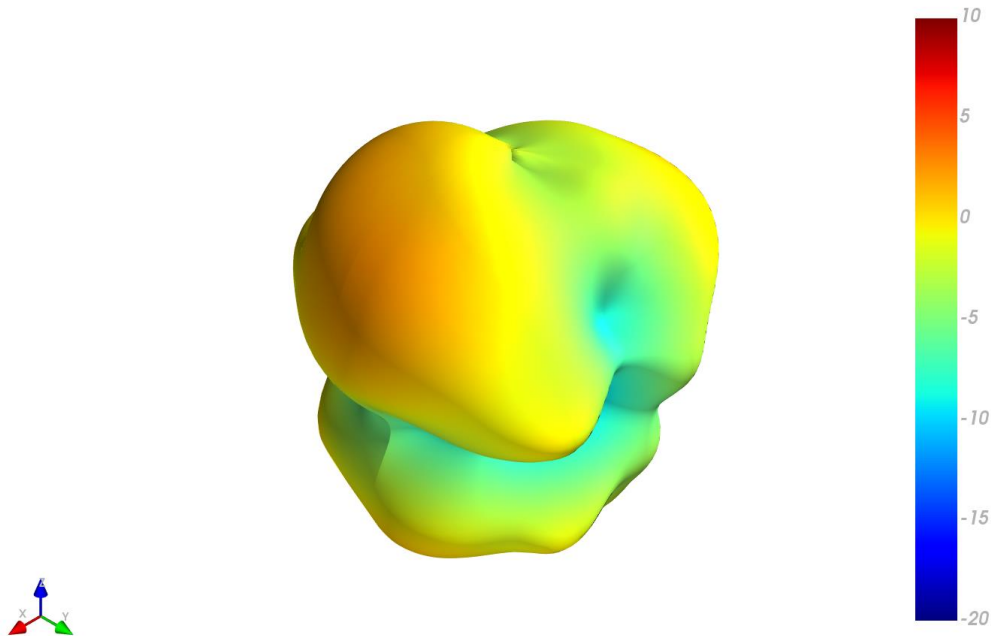

XY Plane

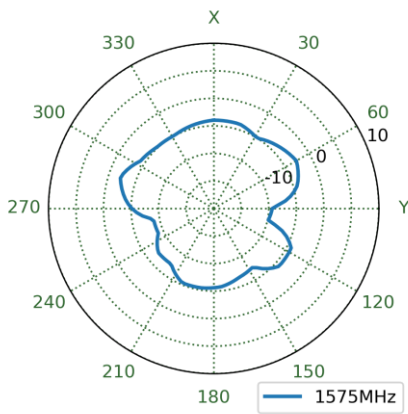

XZ Plane

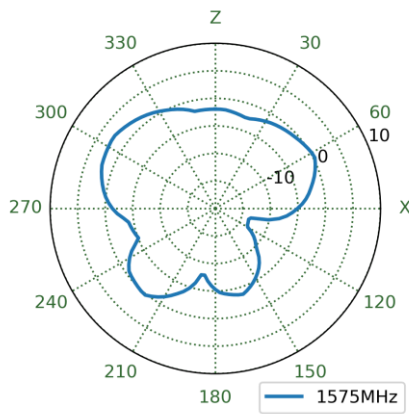

YZ Plane

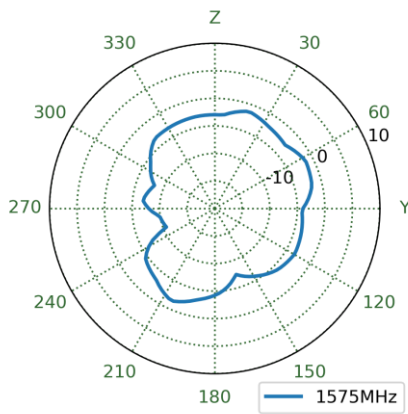

1602MHz

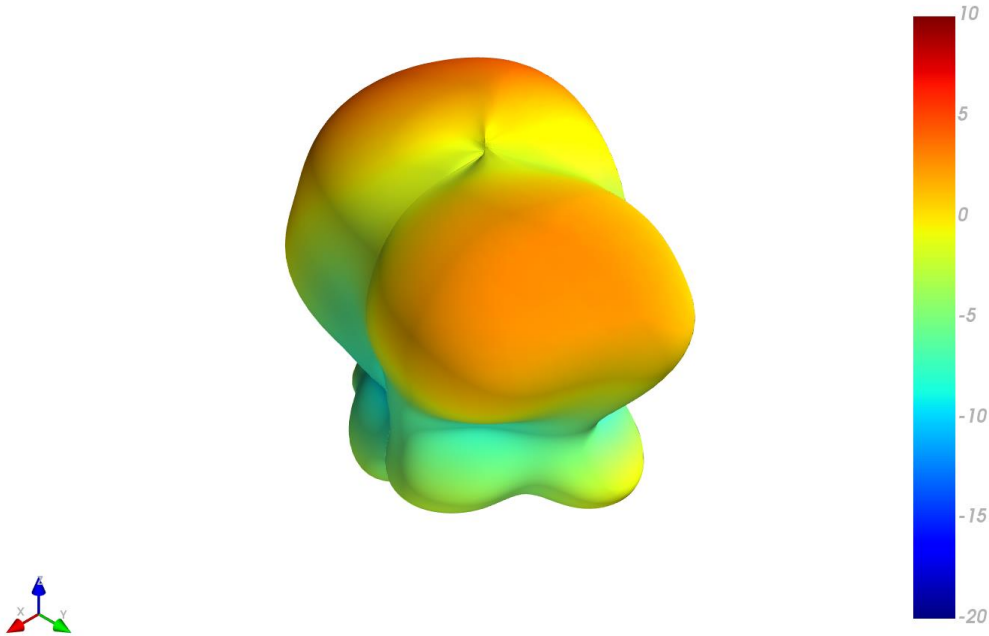

XY Plane

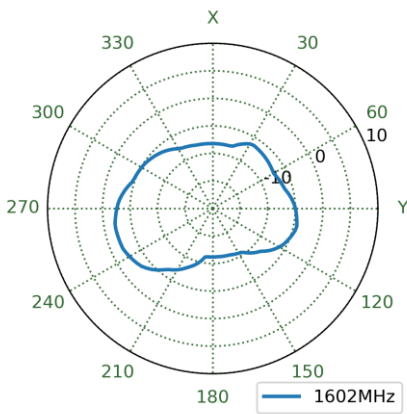

XZ Plane

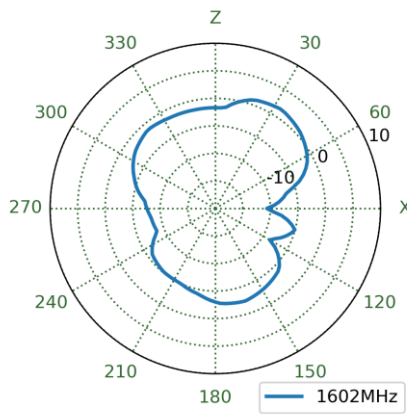

YZ Plane

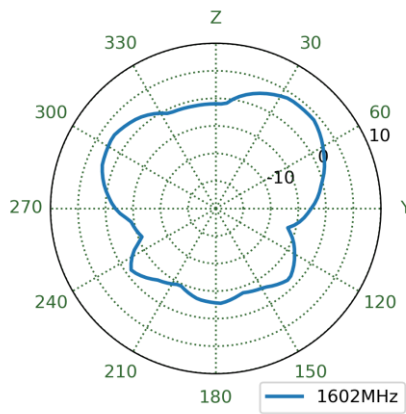

5.3 Cellular 3D and 2D Radiation Patterns – 30\*30cm Ground Plane

751MHz

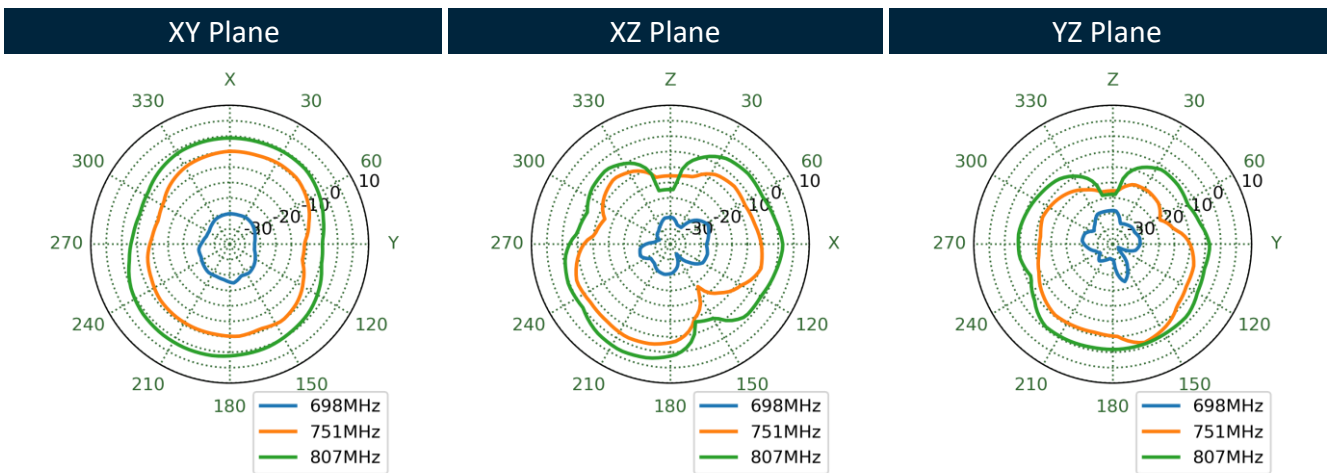
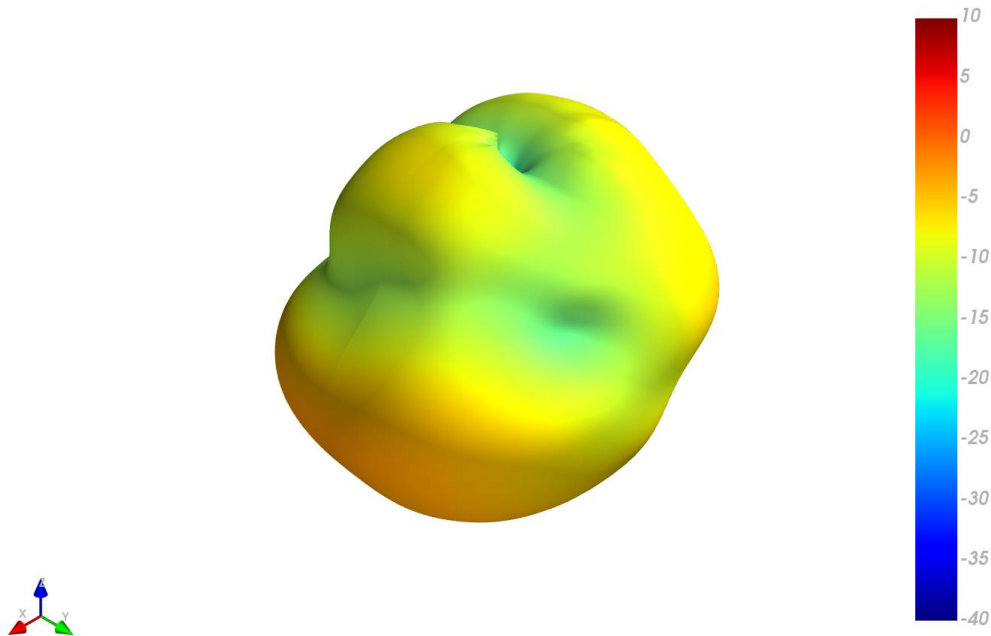

890MHz

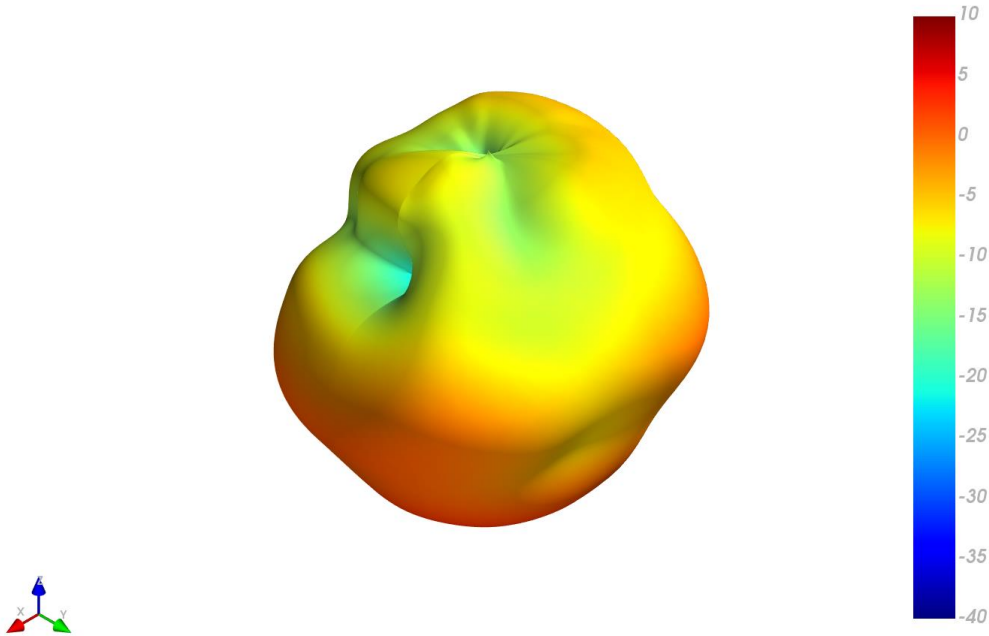

XY Plane

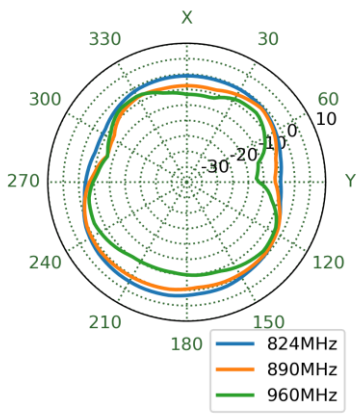

XZ Plane

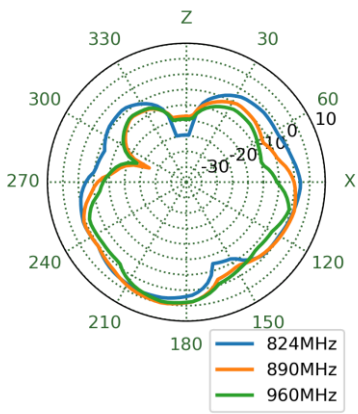

YZ Plane

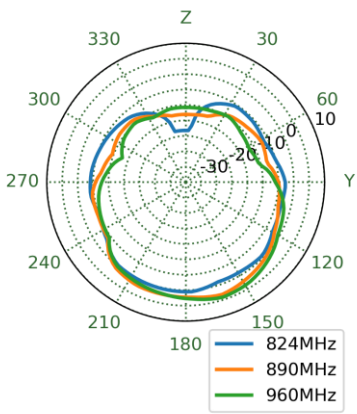

1805MHz

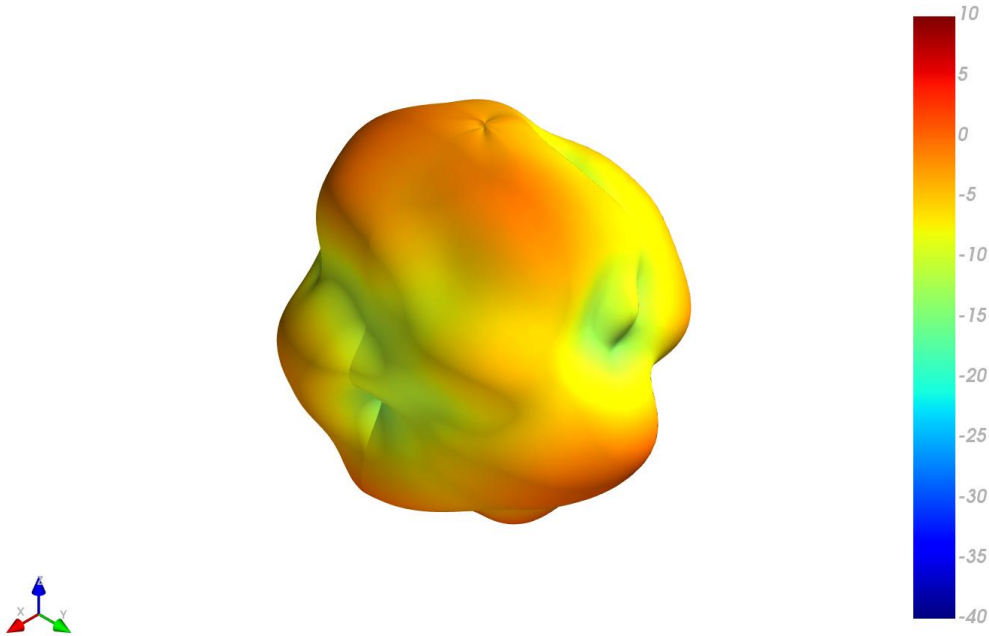

XY Plane

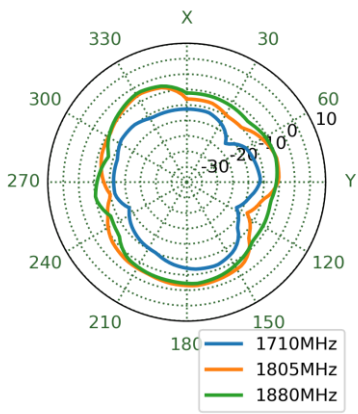

XZ Plane

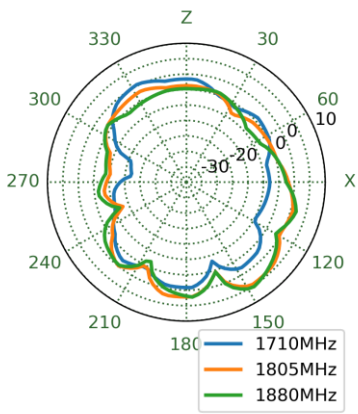

YZ Plane

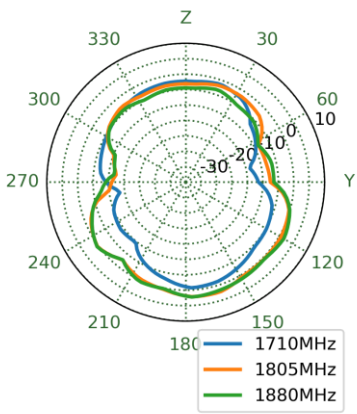

1920MHz

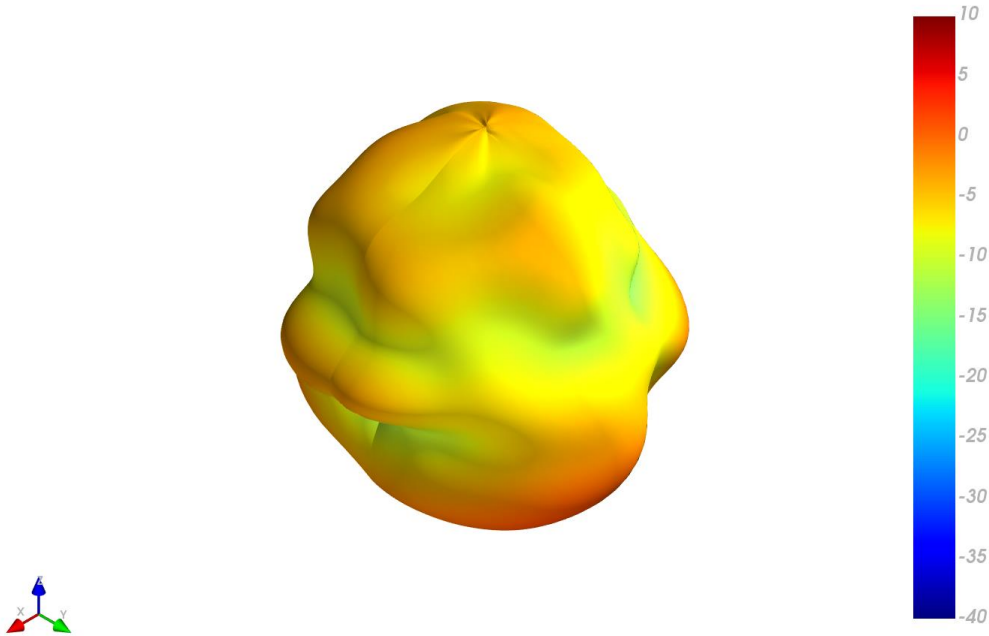

XY Plane

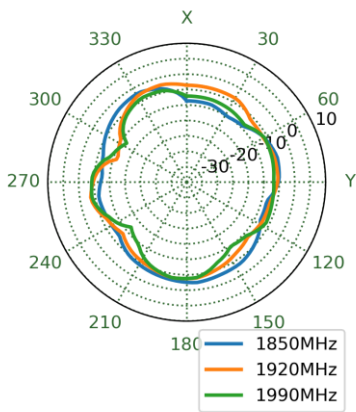

XZ Plane

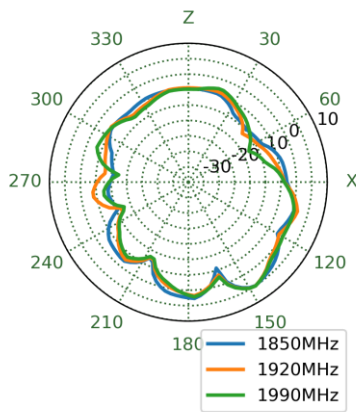

YZ Plane

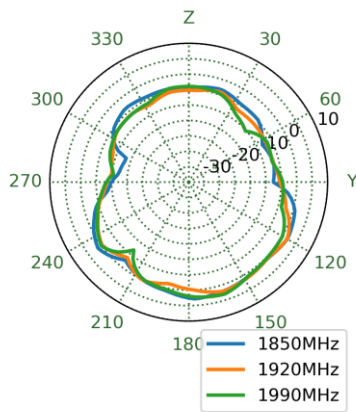



1990MHz

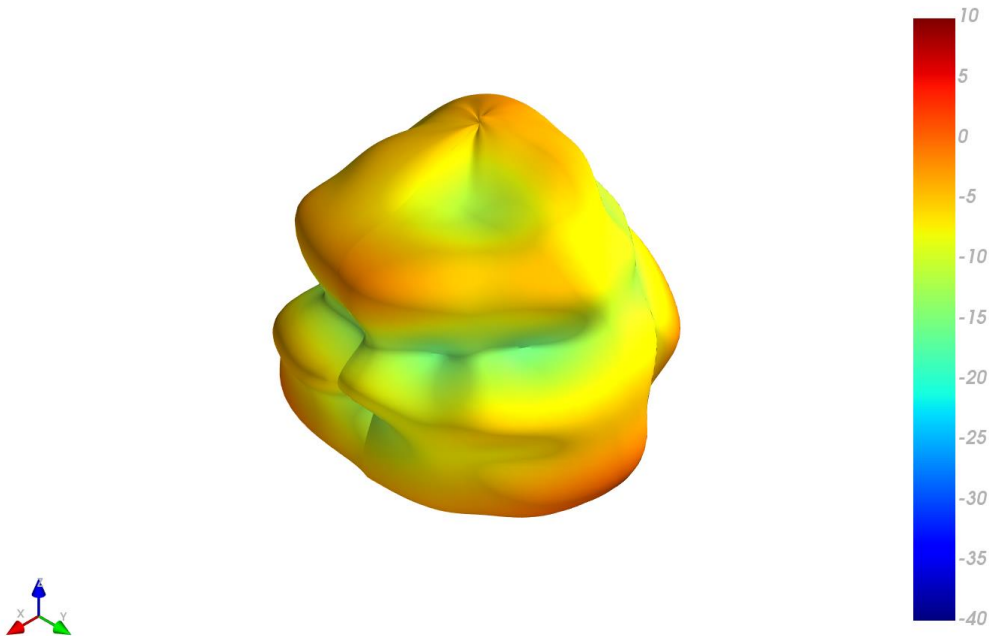

XY Plane

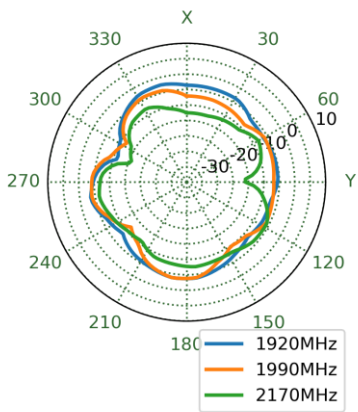

XZ Plane

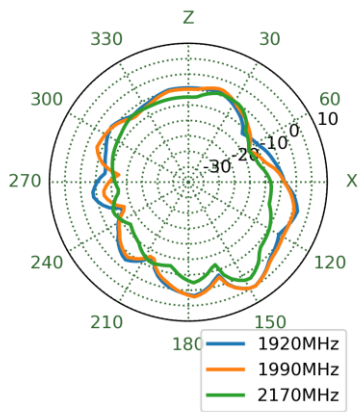

YZ Plane

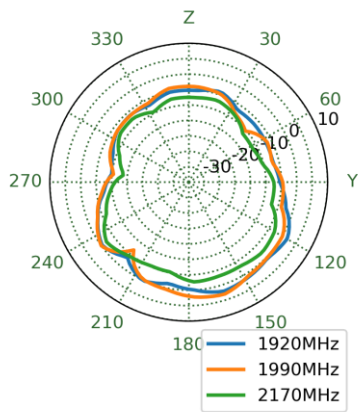

2595MHz

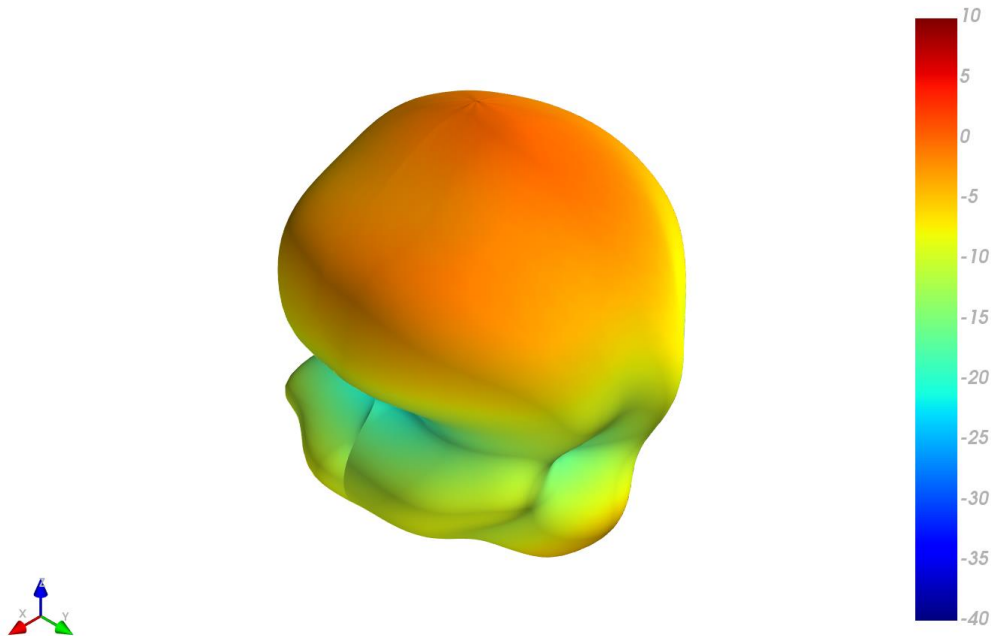

XY Plane

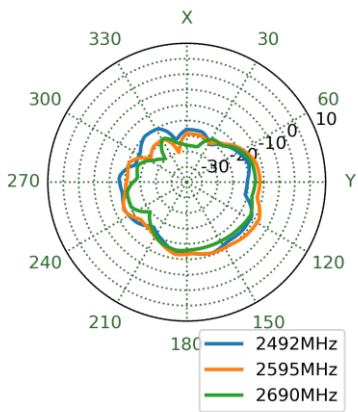

XZ Plane

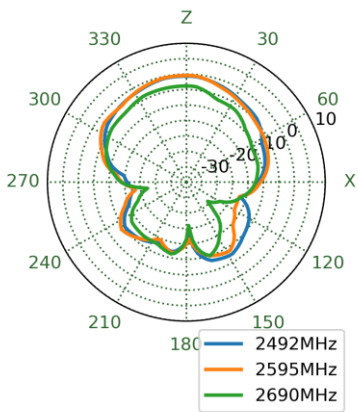

YZ Plane

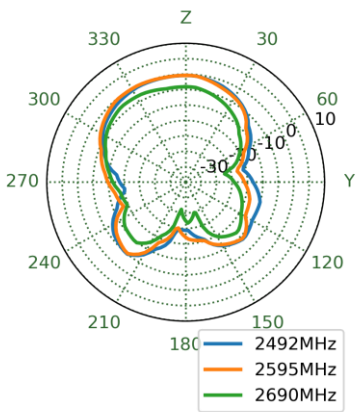

3550MHz

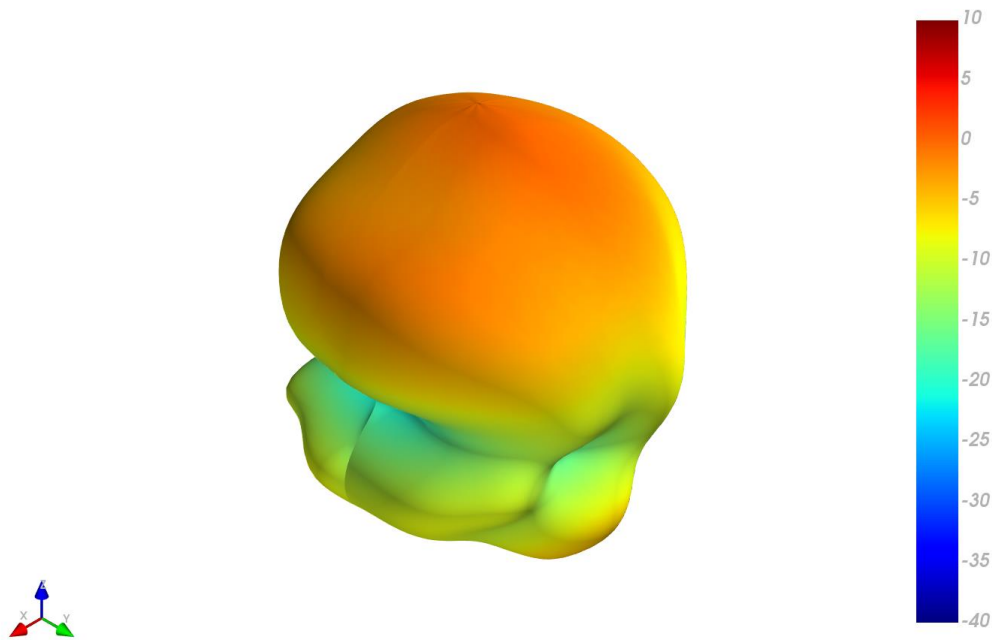

XY Plane

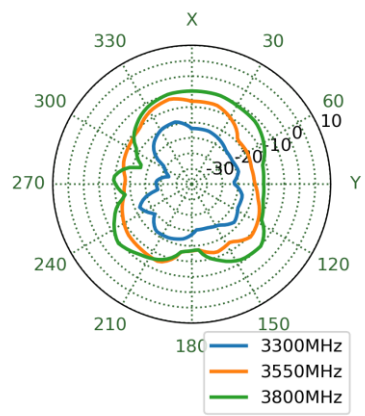

XZ Plane

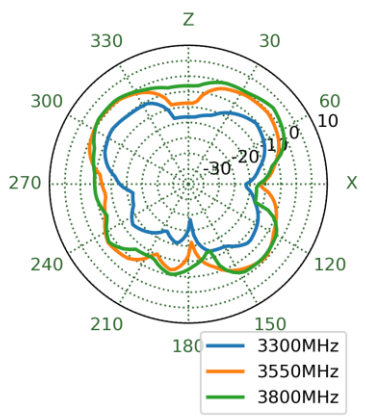

YZ Plane

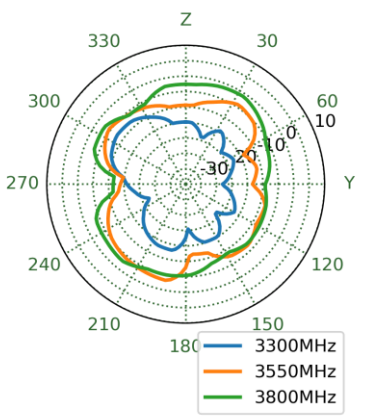

## 5.4 Test Setup – Free Space

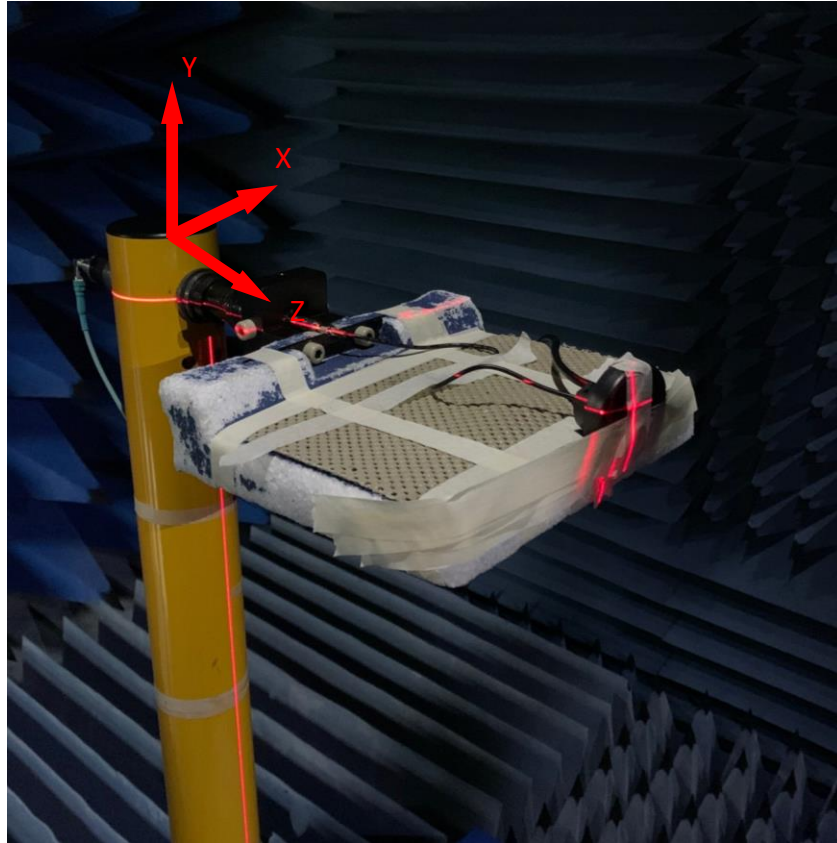

5.5 GNSS 3D and 2D Radiation Patterns – Free Space

1561MHz

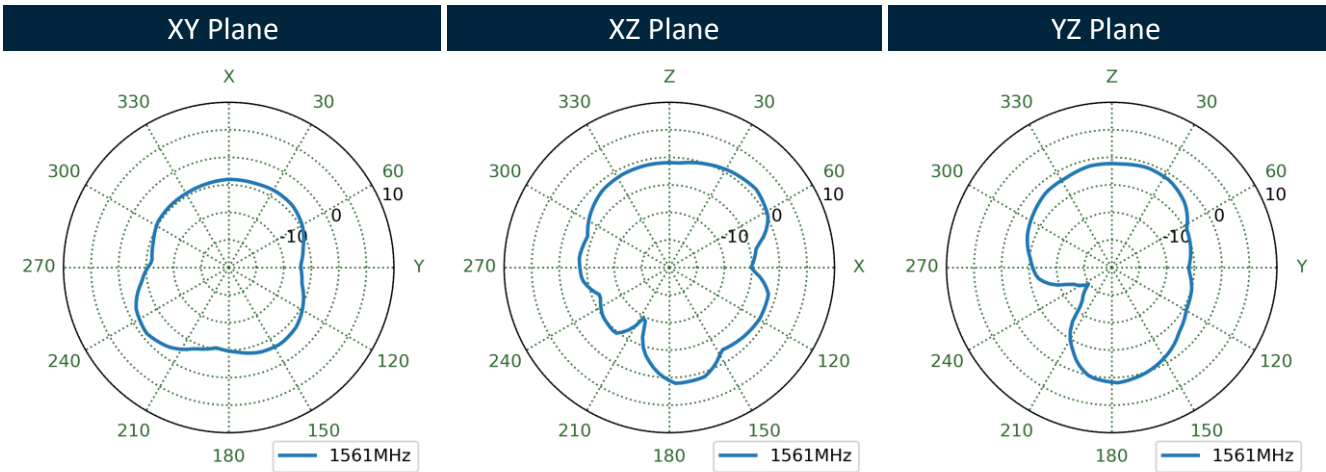
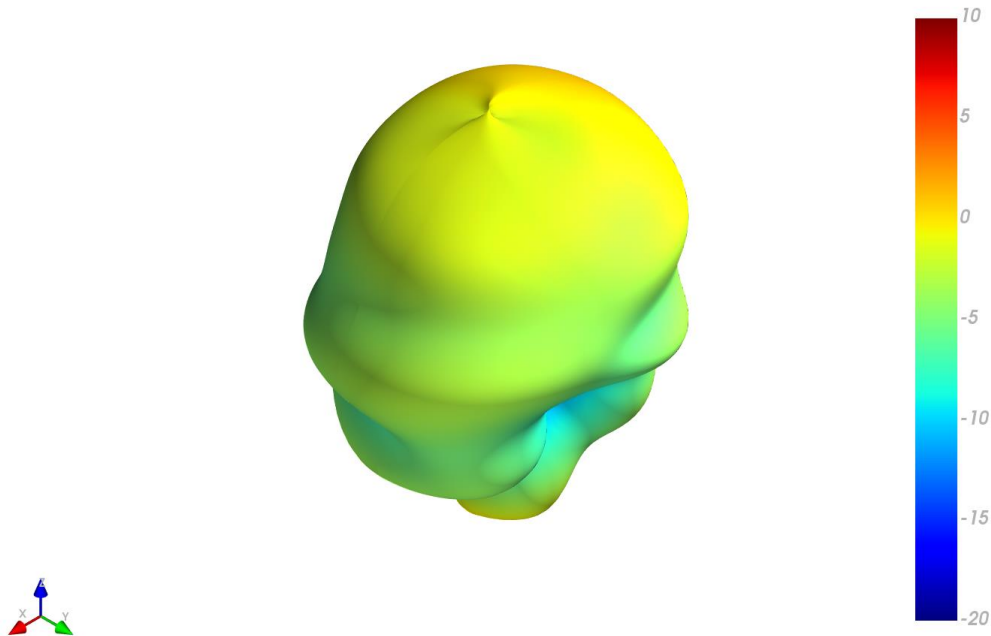

1575.42MHz

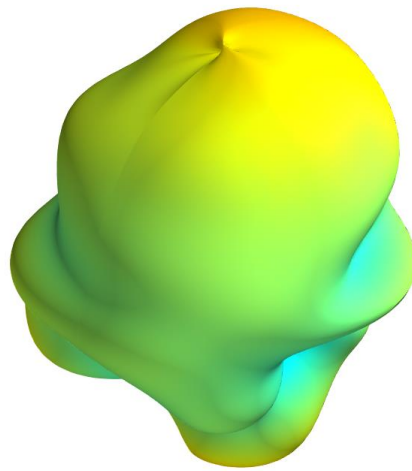

XY Plane

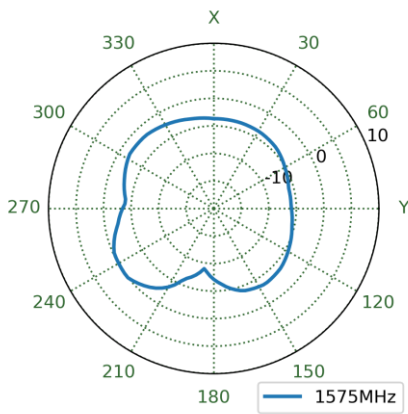

XZ Plane

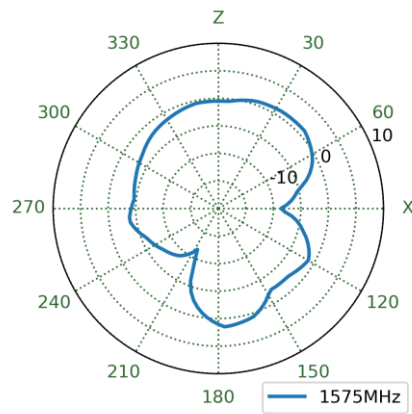

YZ Plane

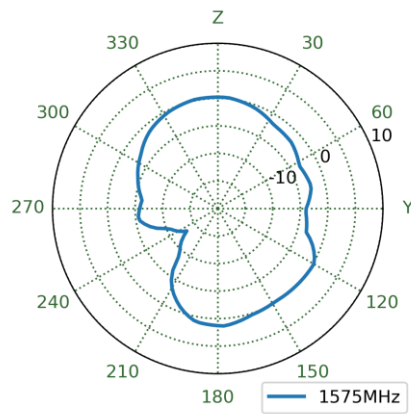

1602MHz

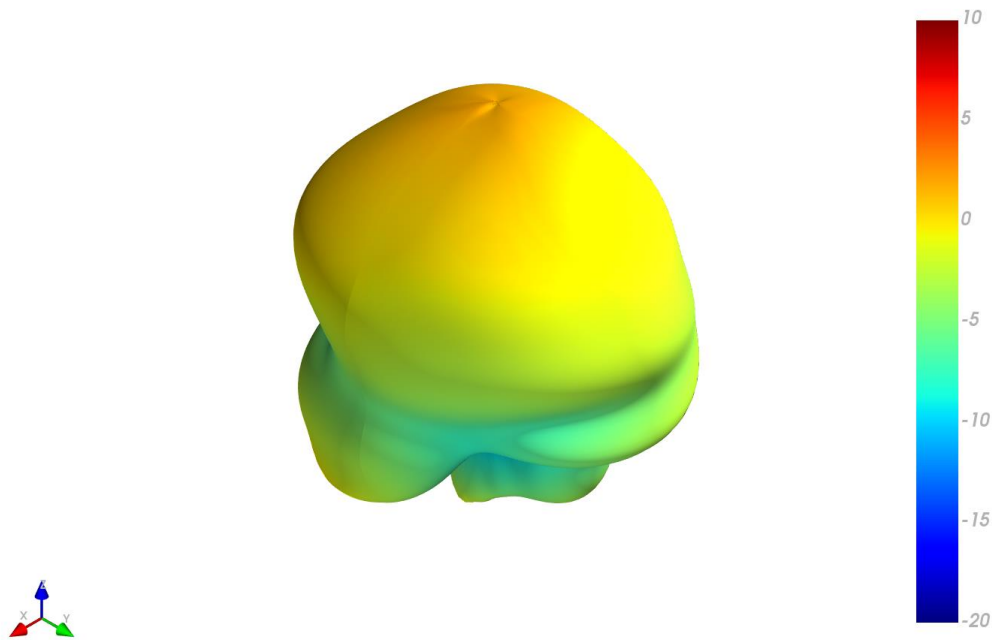

XY Plane

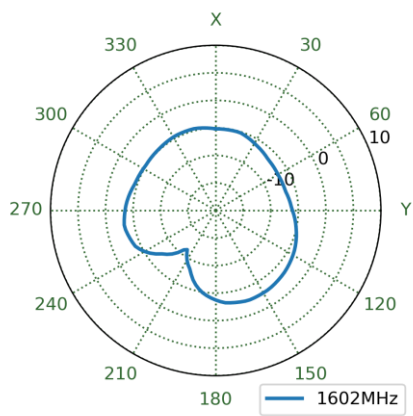

XZ Plane

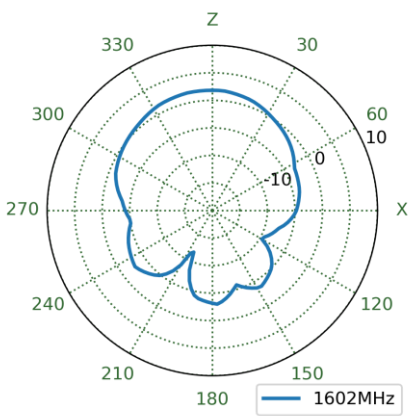

YZ Plane

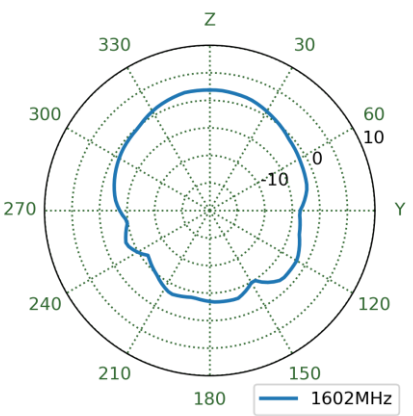

5.6 Cellular 3D and 2D Radiation Patterns – Free Space

751MHz

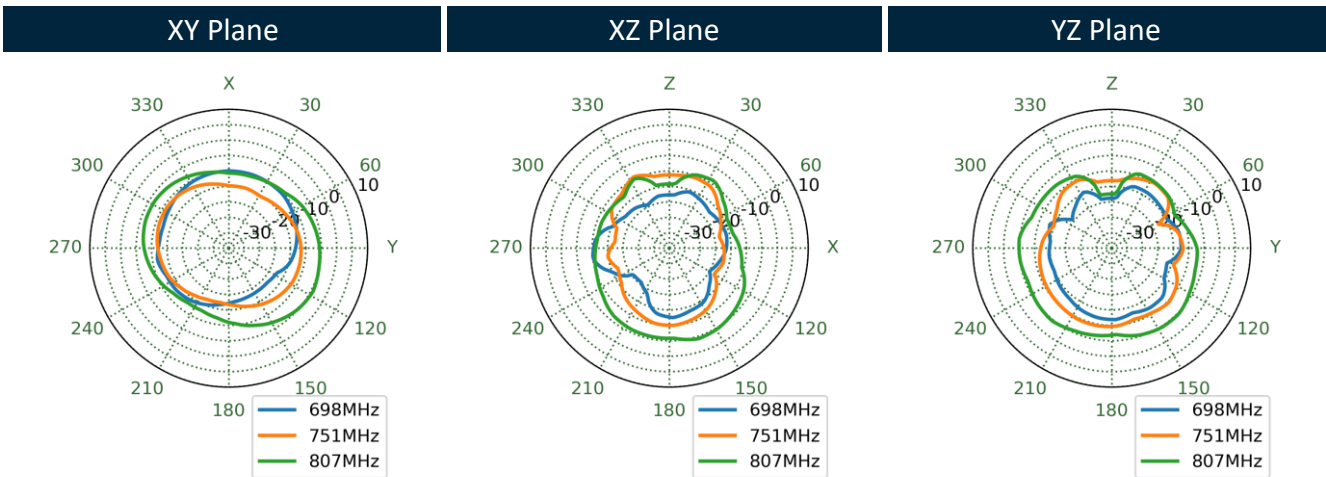
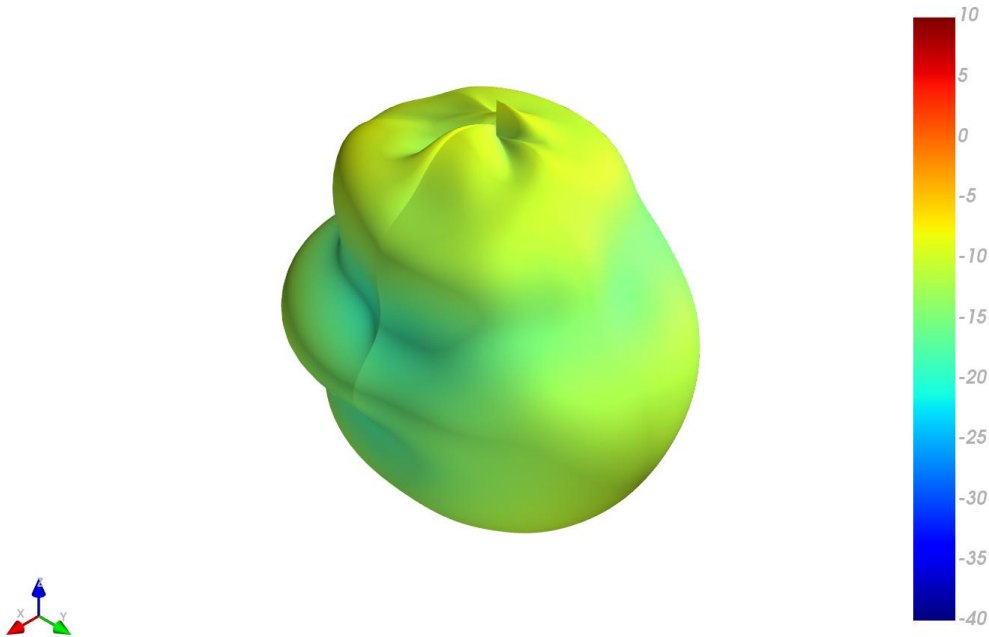



890MHz

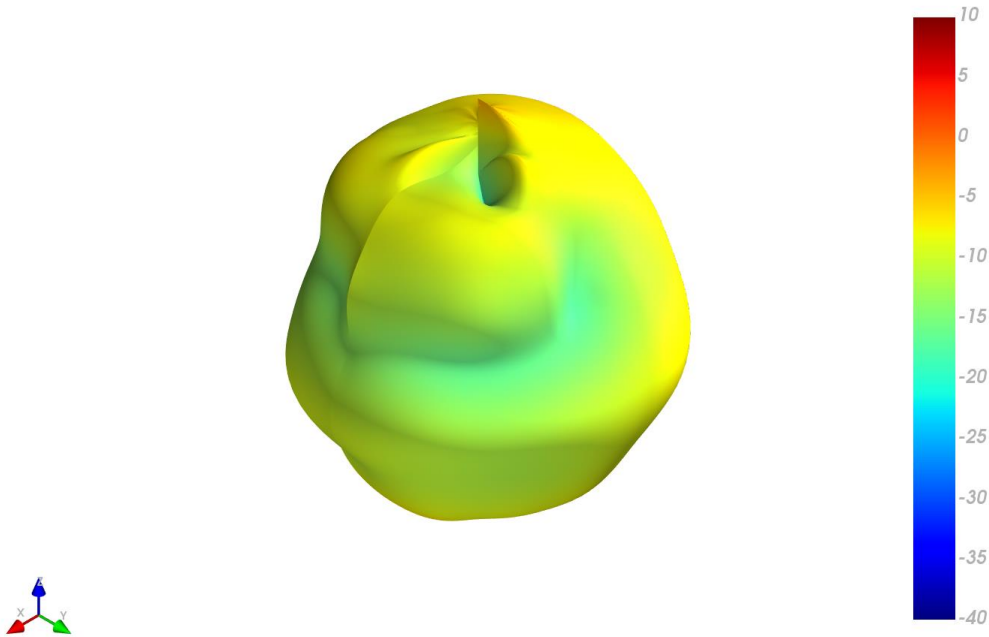

XY Plane

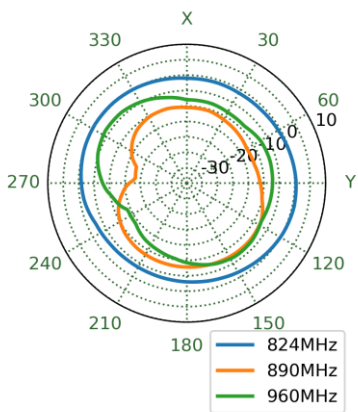

XZ Plane

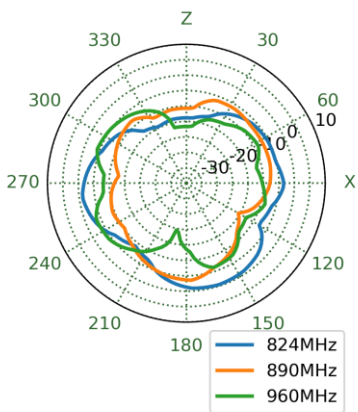

YZ Plane

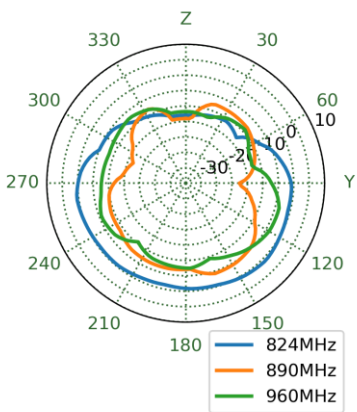

1805MHz

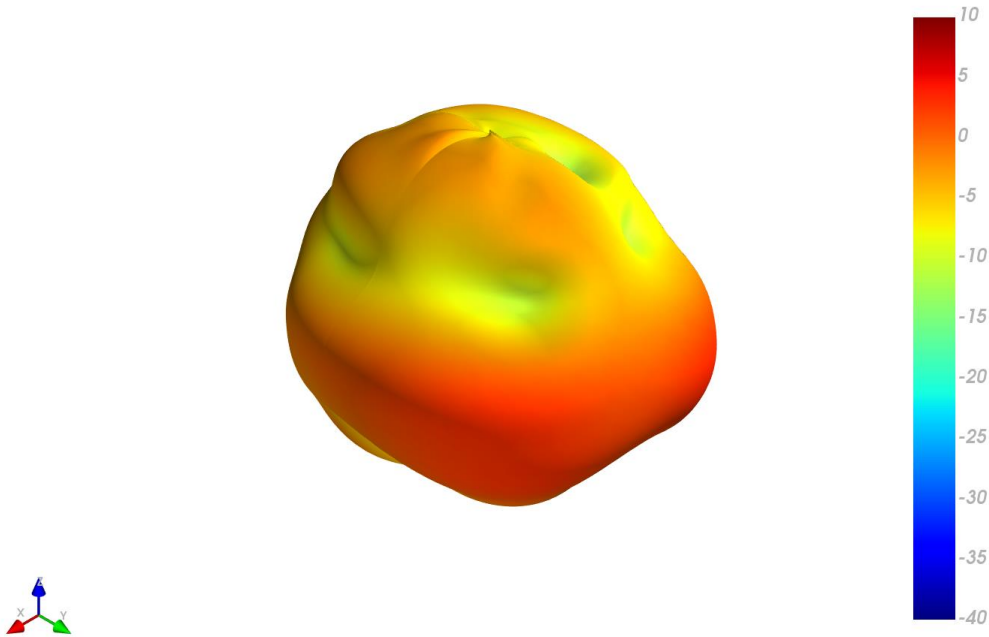

XY Plane

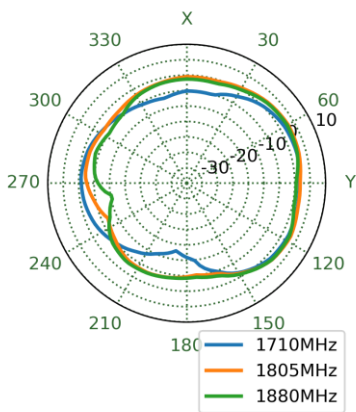

XZ Plane

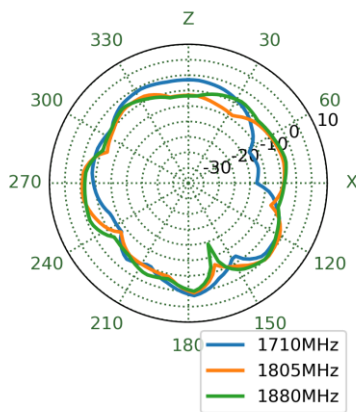

YZ Plane

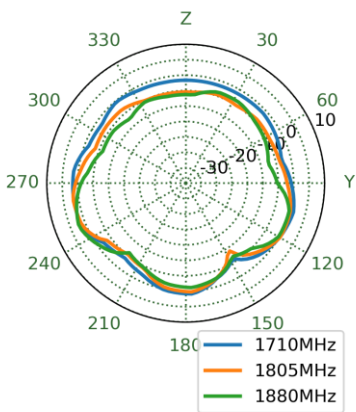

1920MHz

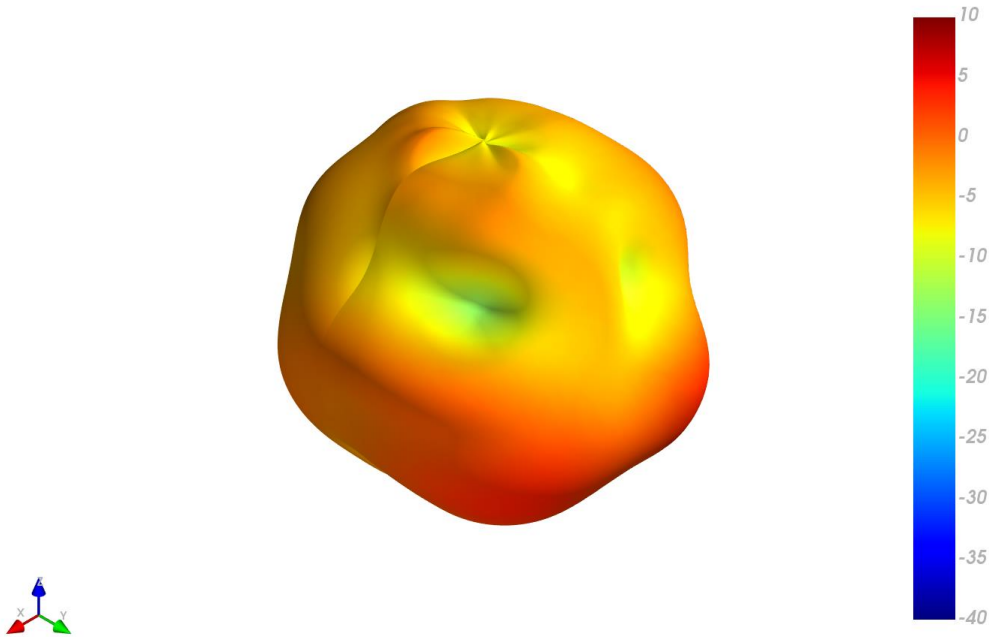

XY Plane

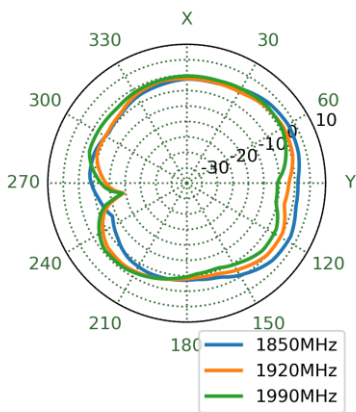

XZ Plane

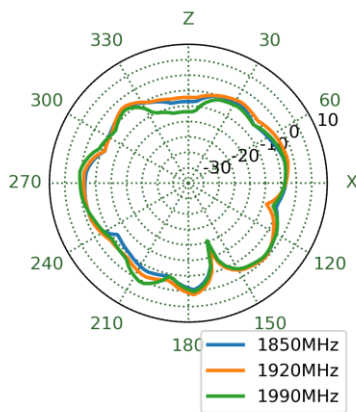

YZ Plane

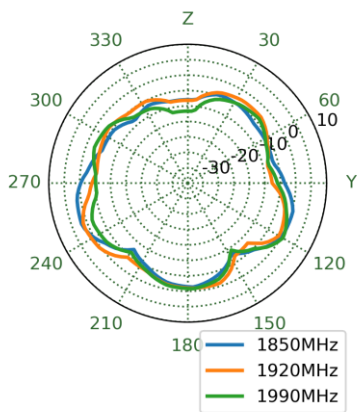

1990MHz

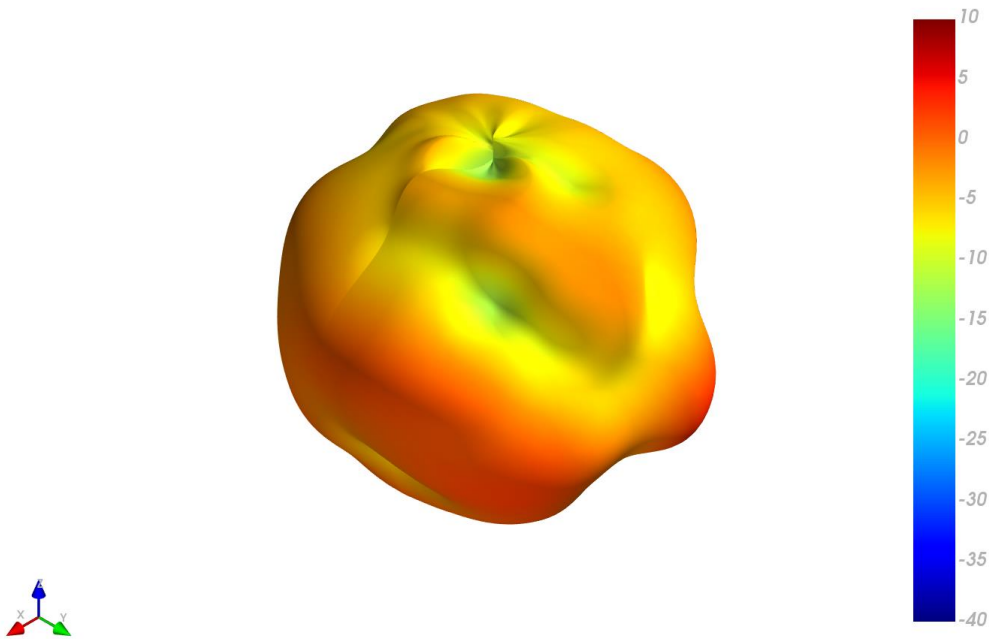

XY Plane

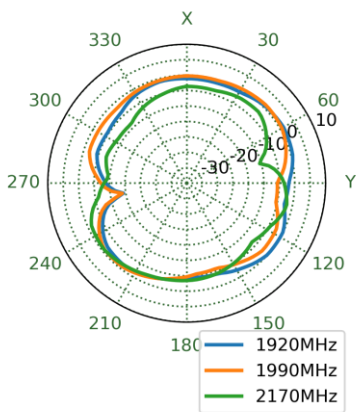

XZ Plane

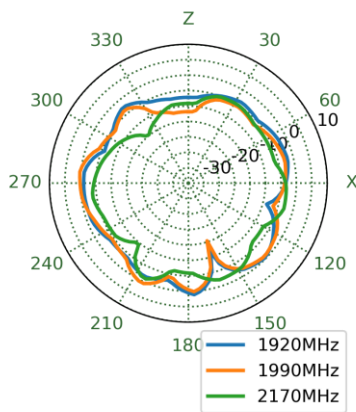

YZ Plane

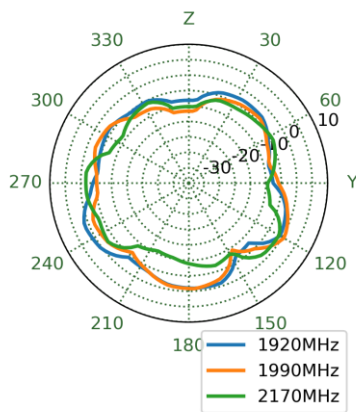

2595MHz

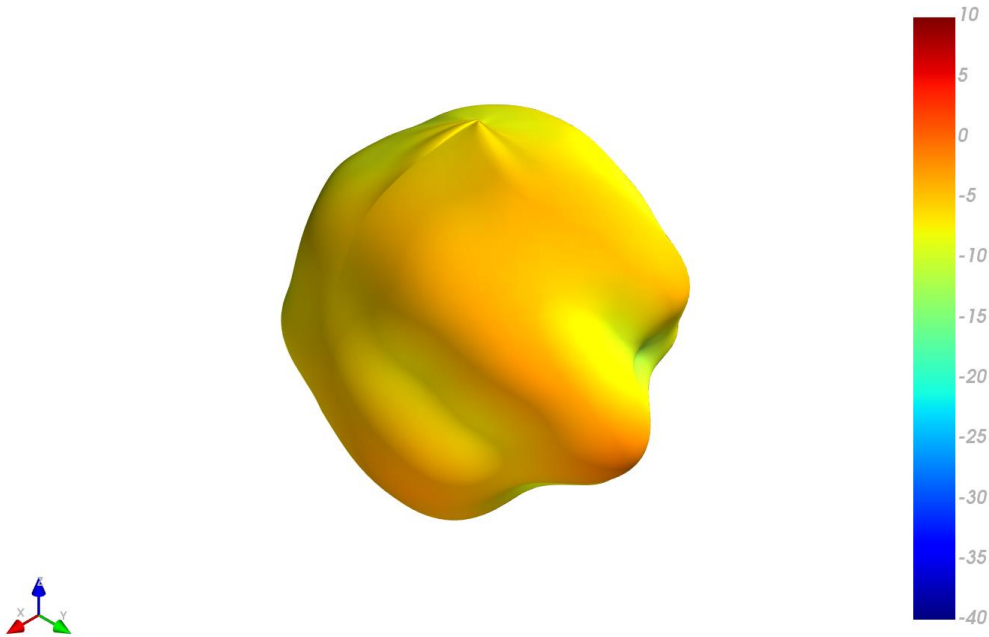

XY Plane

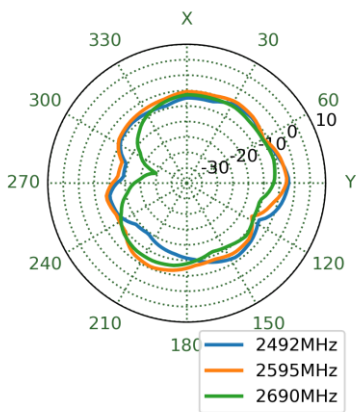

XZ Plane

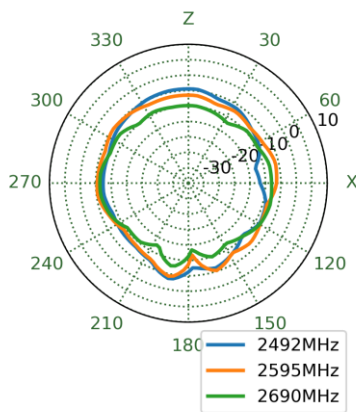

YZ Plane

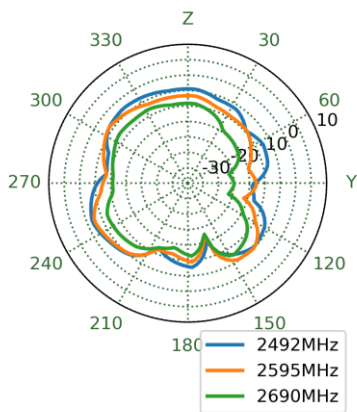

3550MHz

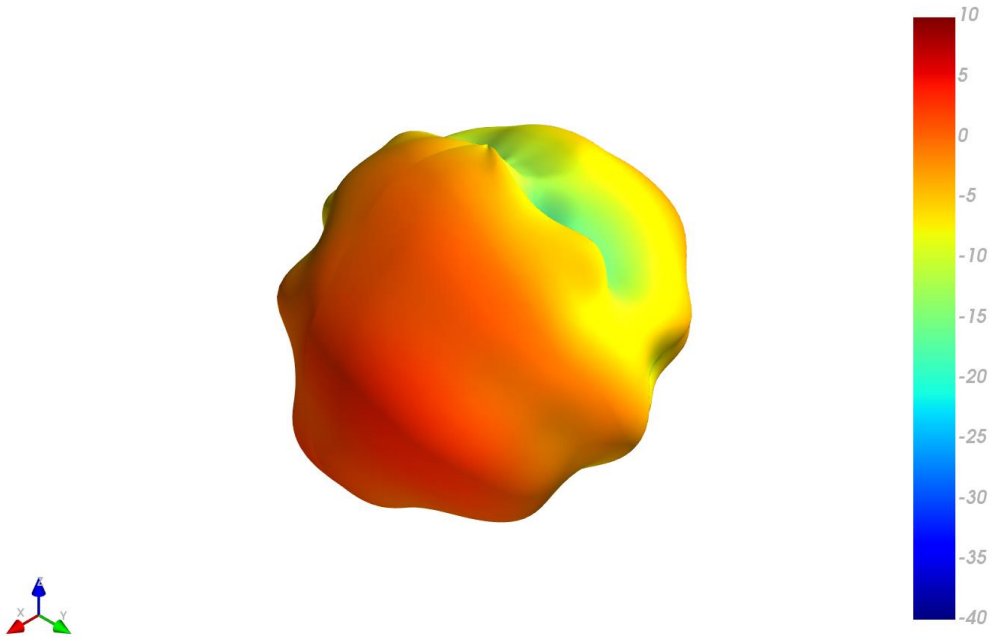

XY Plane

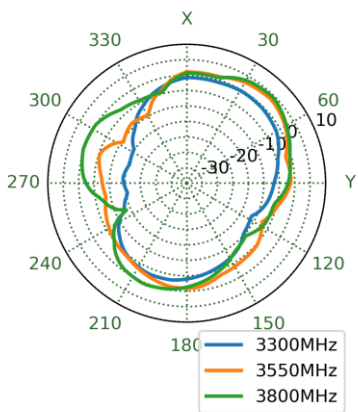

XZ Plane

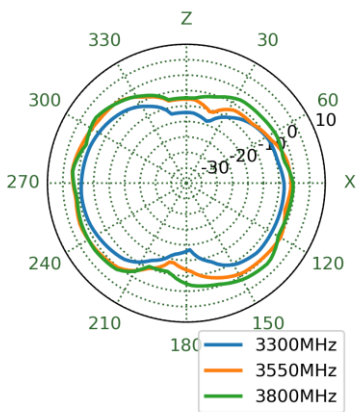

YZ Plane

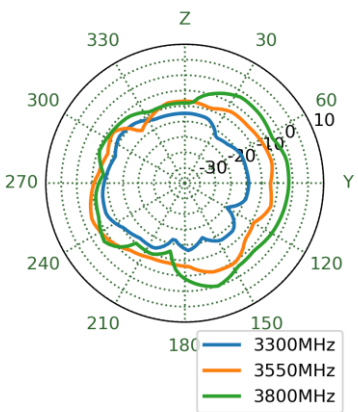

# 6. Mechanical Drawing (Units: mm)

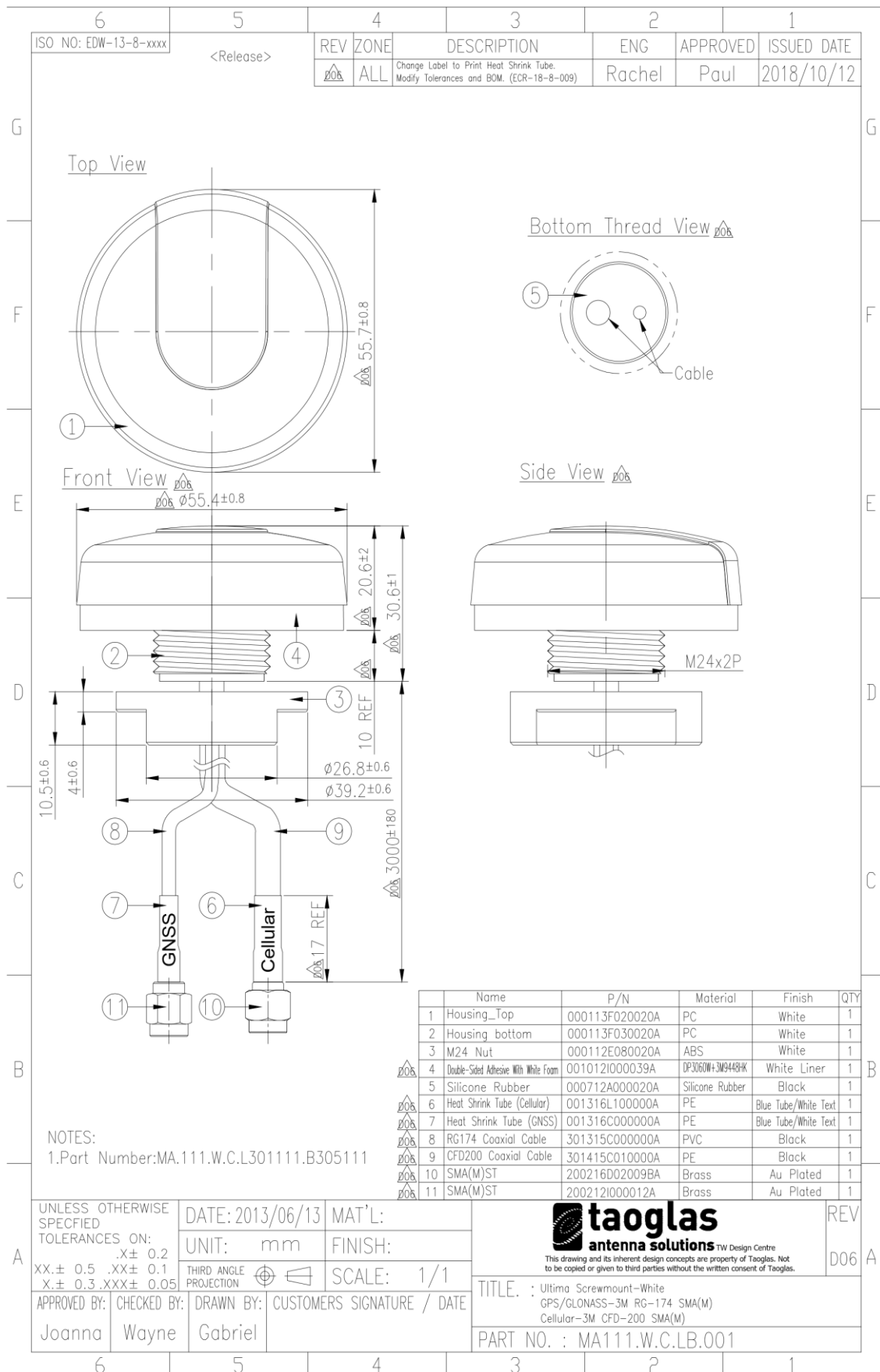

## 7. Installation

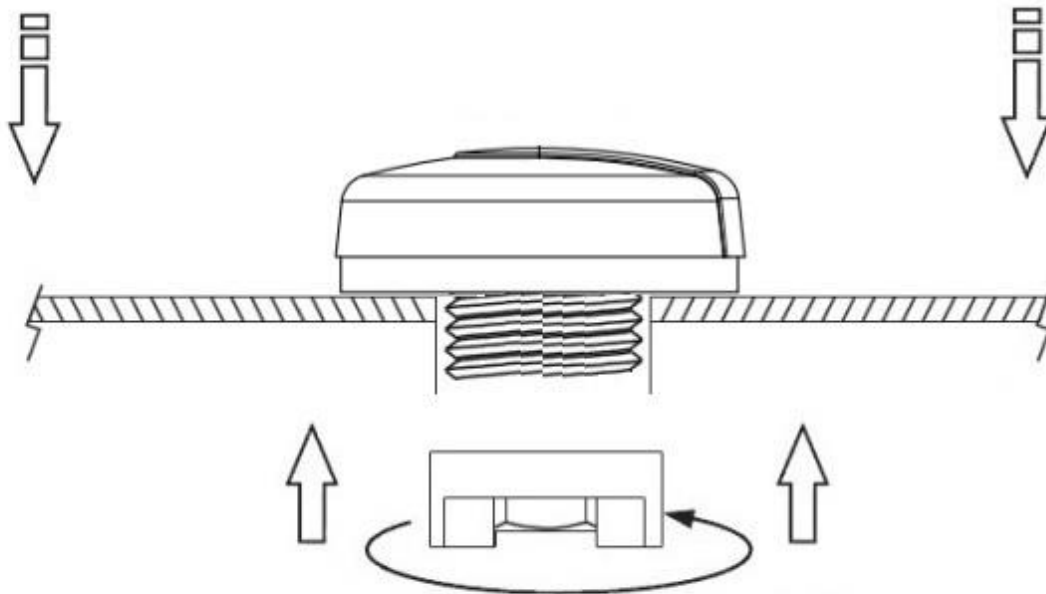

Recommended torque for Mounting is 3.92N·m  
 Maximum torque for Mounting is 4.9N·m

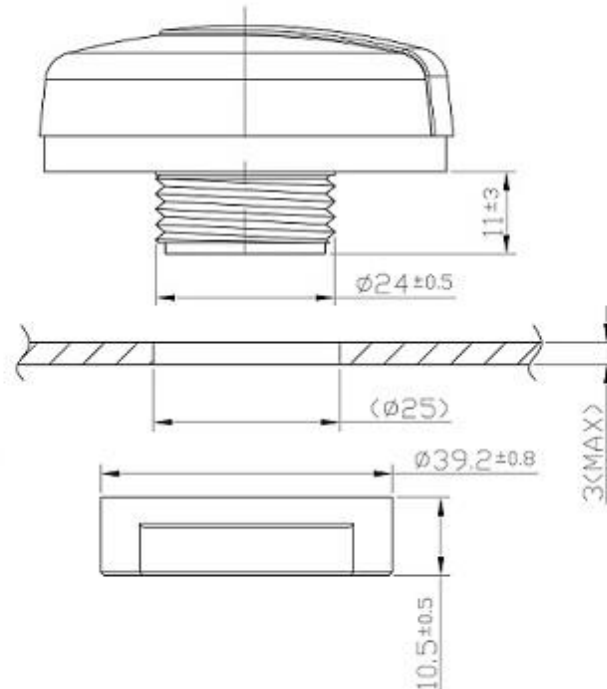



## 8. Packaging

1pcs MA111.W.C.LB.001 per PE Bag  
 Dimensions -  $\varnothing 330 \times 28.4$   
 Weight - 0.21Kg

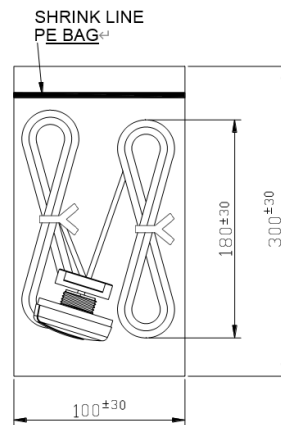

40pcs MA111.W.C.LB.001 per carton  
 Dimensions - 320\*250\*230mm  
 Weight - 8.7Kg

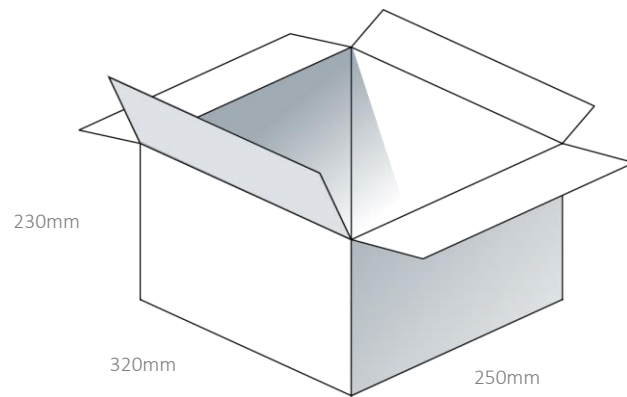

# 9. Application Note

## 9.1 Efficiency – Cellular

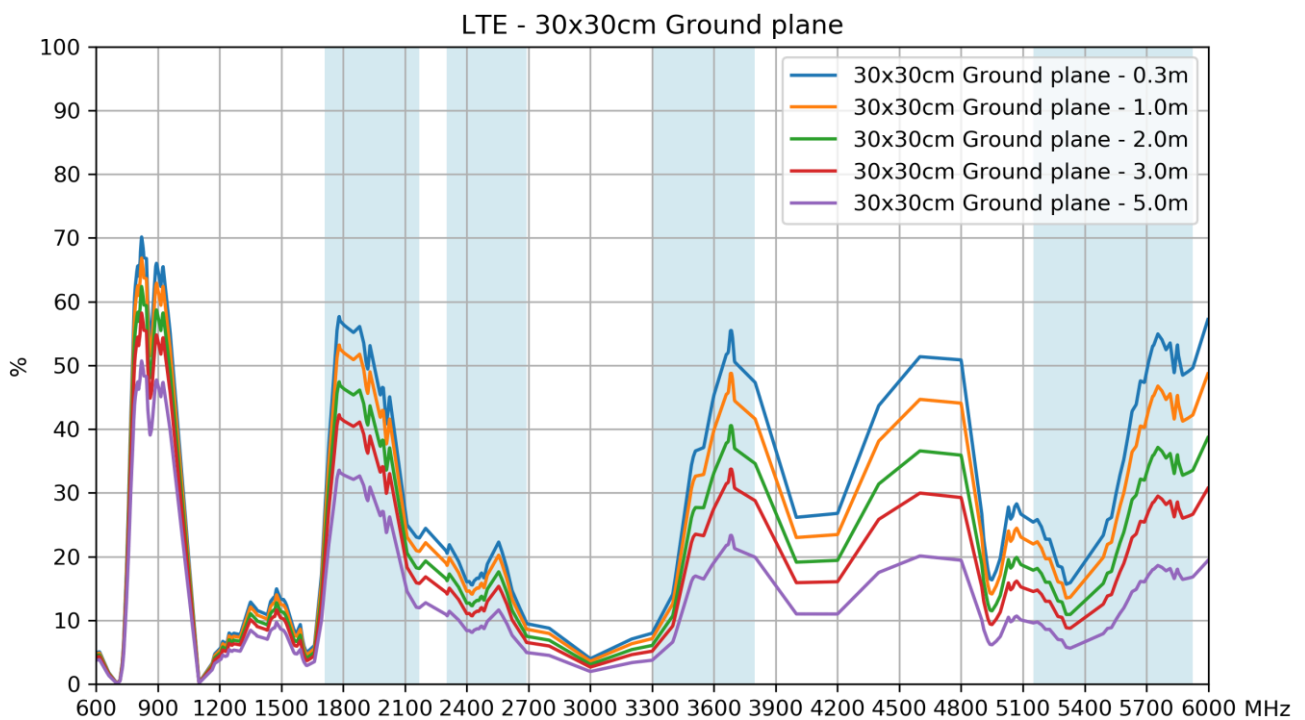
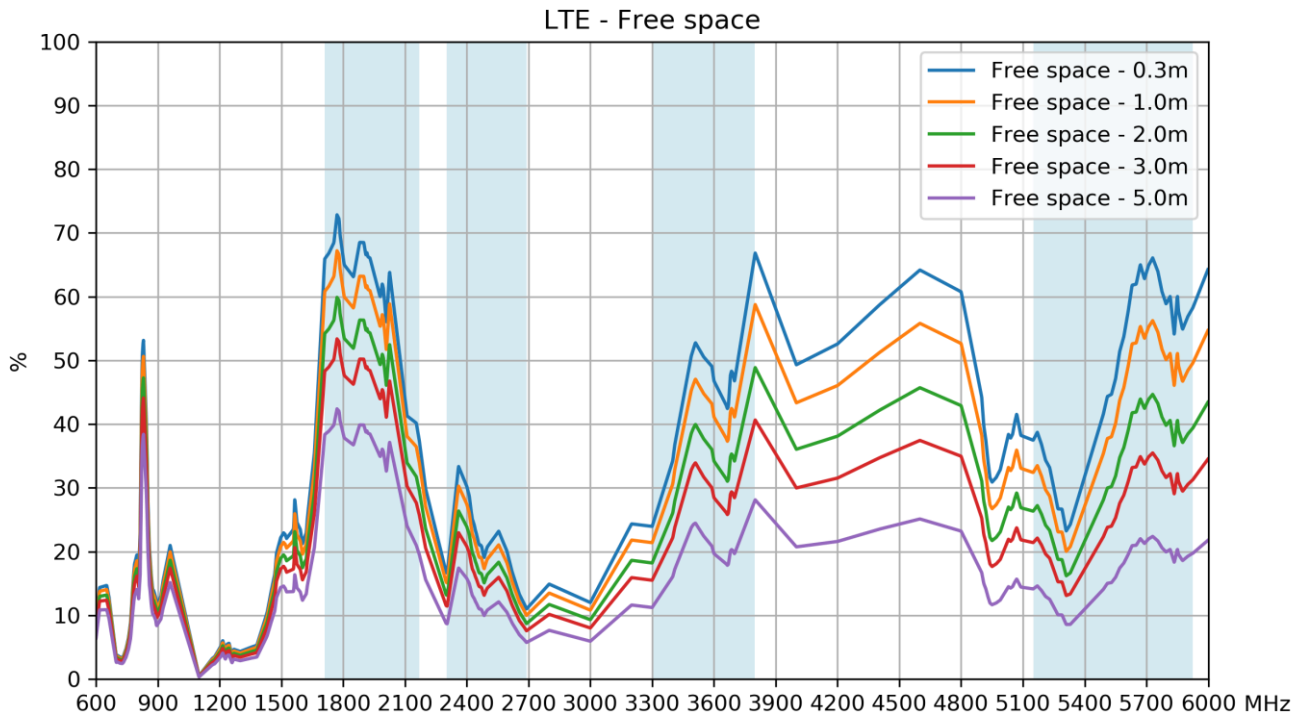

## 9.2 Average Gain – Cellular

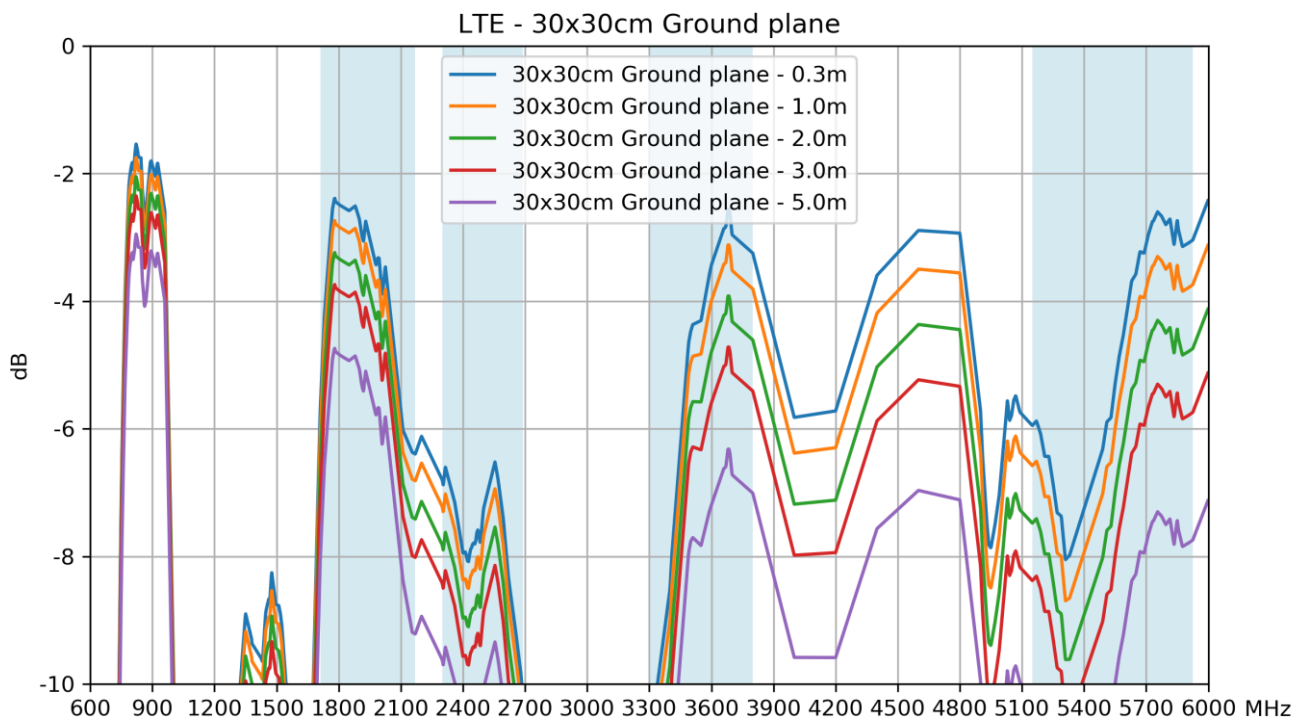
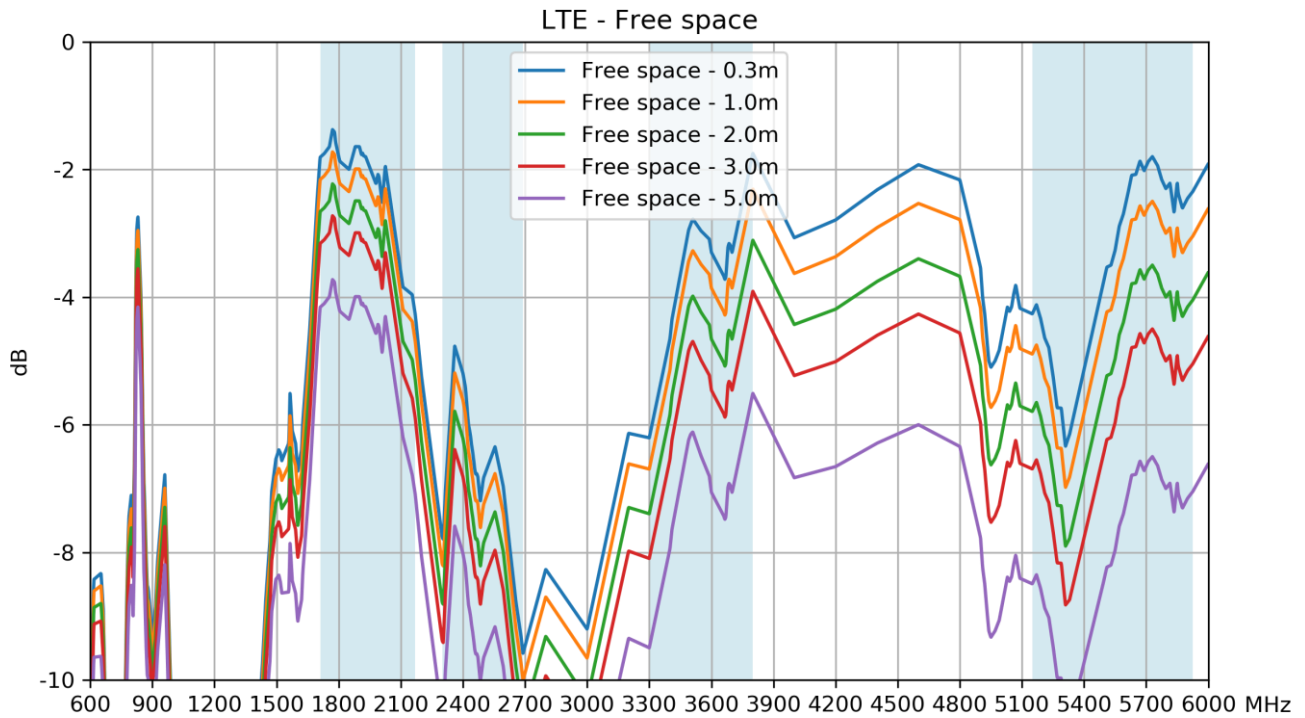

### 9.3 Peak Gain – Cellular

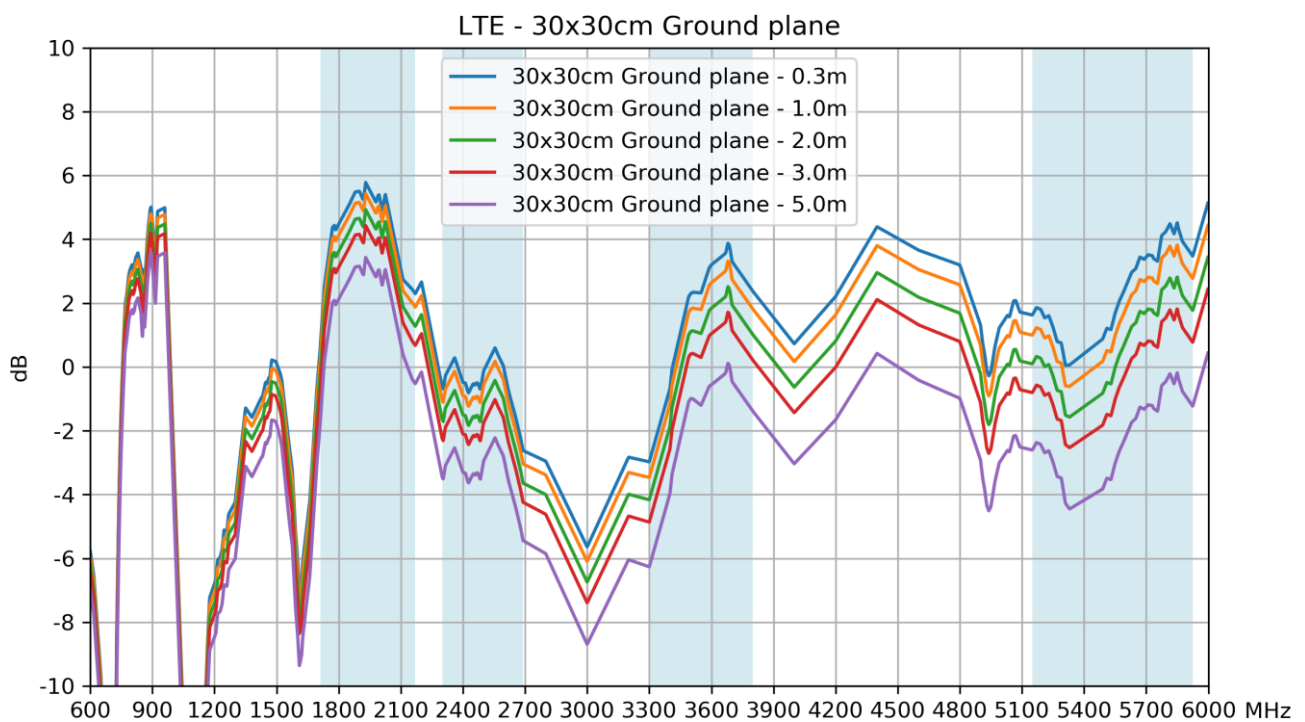
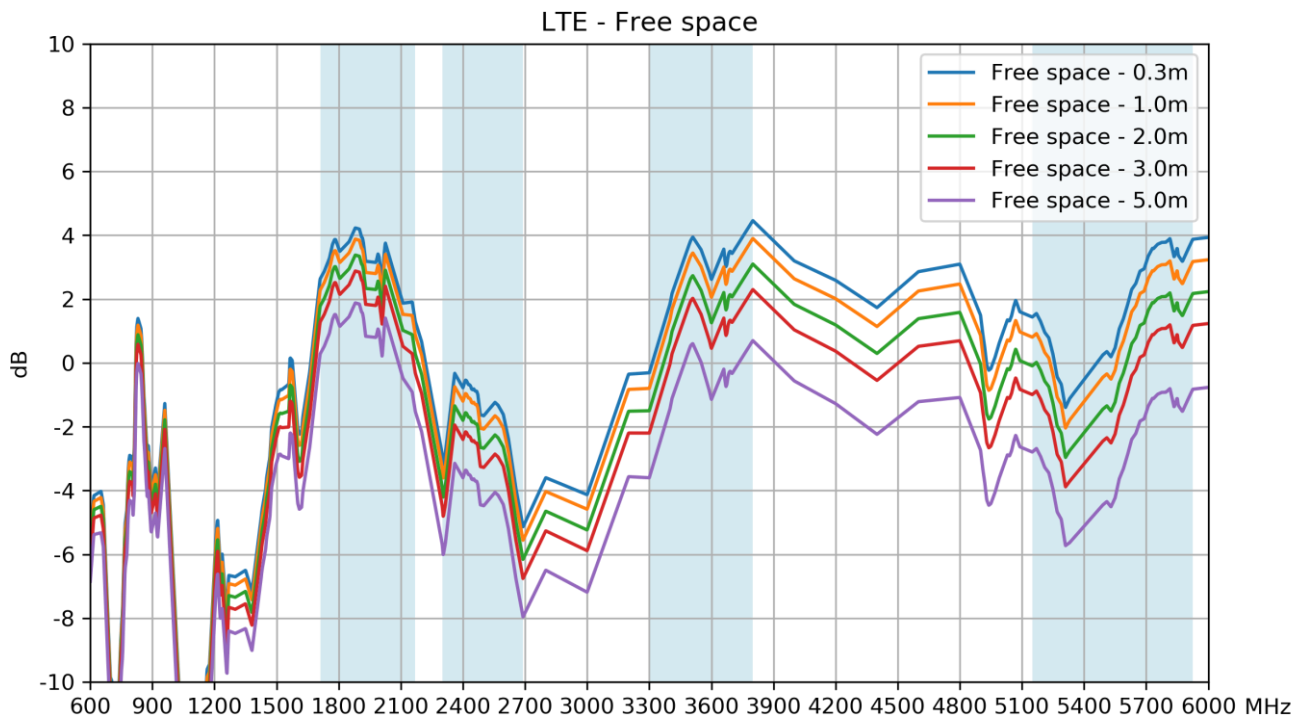

Changelog for the datasheet

**SPE-13-8-040 – MA111.C.LB.001**

**Revision: D (Current Version)**

Date:	2020-02-25
Changes:	Updated to show ground plane data
Changes Made by:	Jack Conroy

**Previous Revisions**

**Revision: C**

Date:	2018-11-29
Changes:	New Table & Drawing Added
Changes Made by:	Jack Conroy

**Revision: B**

Date:	2015-03-11
Changes:	New Drawing Added
Changes Made by:	Aine Doyle

**Revision: A (Original First Release)**

Date:	2013-05-17
Notes:	
Author:	Aine Doyle



**TAOGLAS**®

[www.taoglas.com](http://www.taoglas.com)

