

# NEO/LEA-M8T

## u-blox M8 concurrent GNSS timing modules

### Data sheet



### Abstract

Technical data sheet describing the NEO/LEA-M8T modules with concurrent reception of GPS/QZSS, GLONASS, BeiDou, and Galileo. They provide optimized accuracy and availability with survey-in and single-satellite timing. The modules feature market leading acquisition and tracking sensitivity, minimized power consumption with low duty-cycle operation, and maximized reliability with integrity monitoring and alarms.

# Document information

<b>Title</b>	<b>NEO/LEA-M8T</b>	
<b>Subtitle</b>	u-blox M8 concurrent GNSS timing modules	
<b>Document type</b>	Data sheet	
<b>Document number</b>	UBX-15025193	
<b>Revision and date</b>	R04	5-May-2020
<b>Document status</b>	Production Information	

<b>Product status</b>	<b>Corresponding content status</b>	
<b>In development / Prototype</b>	Objective specification	Target values. Revised and supplementary data will be published later.
<b>Engineering sample</b>	Advance information	Data based on early testing. Revised and supplementary data will be published later.
<b>Initial production</b>	Early production information	Data from product verification. Revised and supplementary data may be published later.
<b>Mass production / End of life</b>	Production information	Document contains the final product specification.

This document applies to the following products:

<b>Product name</b>	<b>Type number</b>	<b>ROM/FLASH version</b>	<b>PCN reference</b>
LEA-M8T	LEA-M8T-0-10	Flash FW 3.01 TIM 1.10	UBX-16004907
NEO-M8T	NEO-M8T-0-10	Flash FW 3.01 TIM 1.10	UBX-16005636
LEA-M8T	LEA-M8T-1-00	Flash FW 3.01 TIM 1.11	

u-blox or third parties may hold intellectual property rights in the products, names, logos and designs included in this document. Copying, reproduction, modification or disclosure to third parties of this document or any part thereof is only permitted with the express written permission of u-blox.

The information contained herein is provided "as is" and u-blox assumes no liability for its use. No warranty, either express or implied, is given, including but not limited to, with respect to the accuracy, correctness, reliability and fitness for a particular purpose of the information. This document may be revised by u-blox at any time without notice. For the most recent documents, visit [www.u-blox.com](http://www.u-blox.com).

Copyright © u-blox AG.

# Contents

<b>1</b>	<b>Functional description .....</b>	<b>6</b>
1.1	Overview.....	6
1.2	Product features .....	6
1.3	Performance.....	7
1.4	Block diagram .....	8
1.5	Supported GNSS constellations .....	8
1.5.1	GPS .....	9
1.5.2	GLONASS .....	9
1.5.3	BeiDou .....	9
1.5.4	Galileo .....	9
1.6	Assisted GNSS (A-GNSS).....	9
1.6.1	AssistNow™ Online.....	10
1.6.2	AssistNow™ Offline.....	10
1.6.3	AssistNow™ Autonomous.....	10
1.7	Augmentation systems .....	10
1.7.1	Satellite-based augmentation system (SBAS) .....	10
1.7.2	QZSS .....	10
1.7.3	IMES .....	11
1.7.4	Differential GPS (D-GPS).....	11
1.8	Precision timing, raw data and low duty-cycle operation .....	11
1.8.1	Time mode.....	11
1.8.2	Timepulse and frequency outputs .....	12
1.8.3	Time mark .....	12
1.8.4	Timing integrity and availability .....	12
1.8.5	Raw data.....	13
1.8.6	Low duty-cycle operation .....	13
1.9	TIMEPULSE .....	14
1.10	Odometer .....	14
1.11	Data logging .....	14
1.12	Geofencing.....	14
1.13	Message integrity protection .....	14
1.14	Spoofing detection .....	15
1.15	EXTINT: External interrupt.....	15
1.15.1	Power control.....	15
1.15.2	Aiding .....	15
1.16	Protocols and interfaces .....	15
1.17	Interfaces.....	15
1.17.1	UART .....	16
1.17.2	USB .....	16
1.17.3	SPI .....	16
1.17.4	Display data channel (DDC) .....	16

1.18	Clock generation.....	16
1.18.1	Oscillators .....	16
1.18.2	Real-time clock (RTC) and hardware backup mode.....	16
1.19	Power management .....	16
1.19.1	Operating modes .....	17
1.19.2	Continuous mode.....	17
1.19.3	On/off interval power save mode.....	17
1.20	Antenna.....	18
1.20.1	Antenna type .....	18
1.20.2	Antenna supervision .....	18
<b>2</b>	<b>Pin definition .....</b>	<b>19</b>
2.1	NEO-M8T pin assignment.....	19
2.2	LEA-M8T pin assignment .....	20
<b>3</b>	<b>Configuration management.....</b>	<b>22</b>
3.1	Interface selection (D_SEL) .....	22
<b>4</b>	<b>Electrical specification .....</b>	<b>23</b>
4.1	Absolute maximum rating.....	23
4.2	Operating conditions.....	24
4.3	Indicative current requirements .....	24
4.4	SPI timing diagrams .....	25
4.4.1	Timing recommendations.....	25
4.5	DDC timing diagrams .....	25
<b>5</b>	<b>Mechanical specifications .....</b>	<b>26</b>
5.1	NEO-M8T .....	26
5.2	LEA-M8T.....	27
<b>6</b>	<b>Reliability tests and approvals.....</b>	<b>28</b>
6.1	Reliability tests.....	28
6.2	Approvals.....	28
<b>7</b>	<b>Product handling and soldering .....</b>	<b>29</b>
7.1	Packaging .....	29
7.1.1	Reels .....	29
7.1.2	NEO-M8T tapes .....	29
7.1.3	LEA-M8T tapes .....	30
7.2	Shipment, storage and handling .....	30
7.2.1	Moisture sensitivity levels .....	30
7.2.2	Reflow soldering.....	30
7.2.3	ESD handling precautions .....	31
<b>8</b>	<b>Default messages.....</b>	<b>32</b>
<b>9</b>	<b>Labeling and ordering information .....</b>	<b>33</b>
9.1	NEO-M8T product labeling .....	33
9.2	LEA-M8T product labeling .....	33
9.3	Explanation of codes .....	34

9.4 Ordering codes.....34

# 1 Functional description

## 1.1 Overview

The NEO-M8T and LEA-M8T concurrent GNSS modules deliver high integrity, precision timing in demanding applications world-wide. Support for BeiDou, GLONASS and Galileo constellations in addition to GPS enables compliance with national requirements. Enhanced sensitivity and concurrent constellation reception extend coverage and integrity to challenging signal environments. Survey-in and fixed-position navigation reduce timing jitter, even at low signal levels, and enable synchronization to be maintained with as few as one single satellite in view. Support for on/off low duty cycle operation reduces power consumption for battery-powered applications.

u-blox timing products include timing integrity measures with receiver autonomous integrity monitoring (RAIM) and continuous phase uncertainty estimation. They feature high dynamic range radios with both analog and digital interference mitigation, supporting applications in wireless communications equipment.

Sophisticated RF architecture and interference suppression ensure maximum performance even in GNSS-hostile environments. The LEA-M8T includes a SAW filter and antenna power supervision and is perfect for use with active antennas or antenna signal distribution systems. The NEO-M8T includes an additional LNA, improving performance when connected directly to a passive antenna, with support for external antenna supply management if required. Both modules include flash memory for field upgrade. UART, SPI and DDC (I2C-compatible) interfaces provide connectivity and enable synergies with most u-blox cellular modules.

The M8T timing modules are delivered in u-blox's established LEA and NEO form-factors with standard pin-out, allowing ready migration from previous product generations.

u-blox timing products can make use of u-blox AssistNow or industry standard aiding data. This reduces the time-to-first-fix and delivers exceptional acquisition sensitivity, even on first installation before precise location, time or frequency are known.

u-blox M8 modules use GNSS chips qualified according to AEC-Q100, are manufactured in ISO/TS 16949 certified sites, and fully tested on a system level. Qualification tests are performed as stipulated in the ISO16750 standard: "Road vehicles – Environmental conditions and testing for electrical and electronic equipment".

## 1.2 Product features

Model	Category	GNSS	Supply	Interfaces	Features	Grade
	Standard Precision GNSS High Precision GNSS Dead Reckoning Timing	GPS/QZSS GLONASS Galileo BeiDou Number of concurrent GNSS	2.7 V – 3.6 V	UART USB SPI DDC (I <sup>2</sup> C compliant)	Programmable (flash) Data logging Carrier phase output Additional SAW Additional LNA VCTCXO Timepulse Frequency output	Standard Professional Automotive
<b>NEO-M8T</b>	•	• • • • •	•	• • • •	• • • • •	•
<b>LEA-M8T</b>	•	• • • • •	•	• • • •	• • • •	•

C = Crystal / T = TCXO

## 1.3 Performance

Parameter	Specification						
Receiver type	72-channel u-blox M8 engine GPS L1C/A, SBAS L1C/A, QZSS L1C/A, QZSS L1 SAIF, GLONASS L1OF, BeiDou B1, Galileo E1B/C						
	GNSS	GPS & GLONASS	GPS & BeiDou	GPS	GLONASS	BeiDou	Galileo
Time-To-First-Fix <sup>1</sup>	Cold start	25 s	28 s	29 s	30 s	34 s	45 s
	Aided start	2 s	2 s	2 s	2 s	3 s	7 s
	Hot start	1 s	1 s	1 s	1 s	1 s	1 s
Sensitivity <sup>2</sup>	Tracking & Navigation	-167 dBm	-166 dBm	-166 dBm	-166 dBm	-159 dBm	-159 dBm
	Aided acquisition <sup>3</sup>	-157 dBm	-157 dBm	-157 dBm	-151 dBm	-146 dBm	-142 dBm
	Reacquisition	-160 dBm	-160 dBm	-160 dBm	-156 dBm	-156 dBm	-153 dBm
	Cold start	-148 dBm	-148 dBm	-148 dBm	-145 dBm	-143 dBm	-138 dBm
	Hot start	-160 dBm	-160 dBm	-160 dBm	-156 dBm	-155 dBm	-151 dBm
Horizontal position accuracy <sup>4</sup>	Autonomous	2.5 m	2.5 m	2.5 m	4.0 m	3.0 m	TBC <sup>5</sup>
	SBAS	2.0 m	2.0 m	2.0 m	N/A	N/A	N/A
Velocity accuracy <sup>6</sup>		0.05 m/s	0.05 m/s	0.05 m/s	0.1 m/s	0.1 m/s	0.1 m/s
Heading accuracy <sup>6</sup>		0.3°	0.3°	0.3°	0.4°	0.5°	0.5°
Max navigation update rate <sup>7</sup>		4 Hz	4 Hz	10 Hz	10 Hz	10 Hz	10 Hz
Time pulse frequency		0.25 Hz...10 MHz					
Time pulse accuracy <sup>8</sup>	Clear sky	≤ 20 ns					
	Indoor	≤ 500 ns					
Operational limits <sup>9</sup>	Dynamics	≤ 4 g					
	Altitude	50,000 m					
	Velocity	500 m/s					

**Table 1: NEO/LEA-M8T performance in different GNSS modes (default: concurrent reception of GPS and GLONASS)**

<sup>1</sup> All satellites at -130 dBm

<sup>2</sup> Demonstrated with a good external LNA

<sup>3</sup> Time: 1s, Position: 1km, Almanac, Ephemeris

<sup>4</sup> CEP, 50%, 24 hours static, -130 dBm, > 6 SVs

<sup>5</sup> To be confirmed when Galileo reaches full operational capability

<sup>6</sup> 50% at 30 m/s

<sup>7</sup> Rates with SBAS disabled for > 98% fix report rate under typical conditions

<sup>8</sup> 1-sigma

<sup>9</sup> Assuming Airborne < 4 g platform

## 1.4 Block diagram

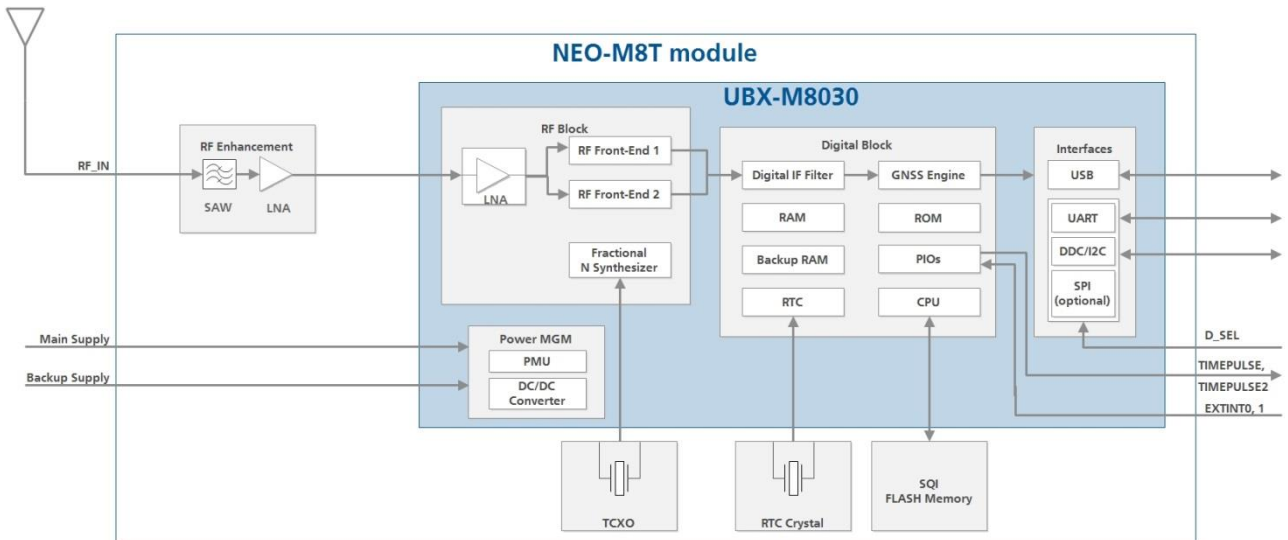

Figure 1: NEO-M8T block diagram

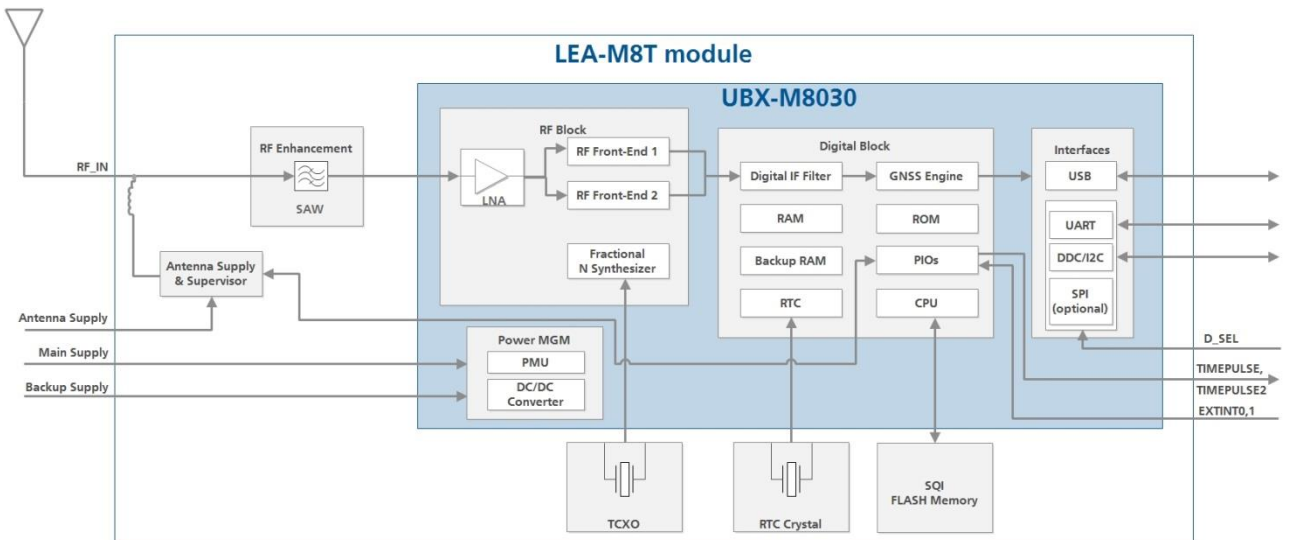

Figure 2: LEA-M8T block diagram

## 1.5 Supported GNSS constellations

The NEO-M8T and LEA-M8T GNSS modules are concurrent GNSS receivers that can receive and track multiple GNSS systems: GPS, Galileo, GLONASS and BeiDou. Owing to the dual-frequency RF front-end architecture, either GLONASS or BeiDou can be processed concurrently with GPS and Galileo signals providing reception of three GNSS systems. By default M8T receivers are configured for concurrent GPS and GLONASS, including QZSS reception. If power consumption is a key factor, then the receiver should be configured for a single GNSS operation using GPS, Galileo, GLONASS or BeiDou with QZSS and SBAS disabled. The modules can be configured to receive any single GNSS constellation or within the set of permissible combinations shown below.



GPS	Galileo	GLONASS	BeiDou
•	•	–	–
•	•	•	–
•	•	–	•
•	–	•	–
•	–	–	•
–	•	•	–
–	•	–	•
–	–	•	•

Table 2 Permissible GNSS combinations (• = enabled)

- The augmentation systems: SBAS and QZSS can be enabled only if GPS operation is configured.
- Galileo is not enabled in the default configuration.

### 1.5.1 GPS

The NEO-M8T and LEA-M8T GNSS modules are designed to receive and track the L1C/A signals provided at 1575.42 MHz by the Global Positioning System (GPS). The modules can receive and process GPS concurrently with Galileo and one of GLONASS or BeiDou.

### 1.5.2 GLONASS

The NEO-M8T and LEA-M8T GNSS modules can receive and process GLONASS concurrently with GPS and Galileo together, or BeiDou. The Russian GLONASS satellite system is a fully deployed alternative to the US-based Global Positioning System (GPS). The modules are designed to receive and track the L1OF signals GLONASS provides around 1602 MHz. The ability to receive and track GLONASS L1OF satellite signals allows design of GLONASS receivers where required by regulations.

### 1.5.3 BeiDou

The NEO-M8T and LEA-M8T GNSS modules can receive and process BeiDou concurrently with GPS and Galileo together, or GLONASS. The modules are designed to receive and track the B1 signals provided at 1561.098 MHz by the BeiDou navigation satellite system. The ability to receive and track BeiDou B1 satellite signals in conjunction with GPS results in higher coverage, improved reliability and better accuracy.

### 1.5.4 Galileo

The NEO-M8T and LEA-M8T GNSS modules can receive and track the E1-B/C signals centered on the GPS L1 frequency band. GPS and Galileo signals can be processed concurrently together with either BeiDou or GLONASS signals, enhancing coverage, reliability and accuracy. The SAR return link message (RLM) parameters for both short and long versions are decoded by the receiver and made available to users via UBX proprietary messages. See the u-blox 8 / u-blox M8 Receiver Description including Protocol Specification [3] for more information.

- For further guidance on the use of specific GNSS constellations in timing applications, contact your local u-blox support team.

## 1.6 Assisted GNSS (A-GNSS)

Supply of aiding information, such as ephemeris, almanac, approximate position and time, will reduce the time-to-first-fix significantly and improve the acquisition sensitivity. The NEO-M8T and LEA-M8T products support the u-blox AssistNow Online and AssistNow Offline A-GNSS services, support AssistNow Autonomous, and are OMA SUPL-compliant.

### 1.6.1 AssistNow™ Online

With AssistNow Online, an internet-connected GNSS device downloads assistance data from u-blox's AssistNow Online Service at system start-up. AssistNow Online is network-operator independent and globally available. Devices can be configured to request only ephemeris data for those satellites currently visible at their location, thus minimizing the amount of data transferred.

 The AssistNow Online service provides data for GPS, GLONASS, BeiDou, Galileo and QZSS.

### 1.6.2 AssistNow™ Offline

With AssistNow Offline, users download u-blox's long-term orbit data from the internet at their convenience. The orbit data can be stored in the NEO-M8T and LEA-M8T GNSS receivers' SQI flash memory. Thus the service requires no connectivity at system start-up, enabling a position fix within seconds, even when no network is available. AssistNow Offline offers augmentation for up to 35 days.

 AssistNow Offline service provides data for GPS and GLONASS only, BeiDou and Galileo are not currently supported.

### 1.6.3 AssistNow™ Autonomous

AssistNow Autonomous provides aiding information without the need for a host or external network connection. Based on previous broadcast satellite ephemeris data downloaded to and stored by the GNSS receiver, AssistNow Autonomous automatically generates accurate satellite orbital data ("AssistNow Autonomous data") that is usable for future GNSS position fixes. The concept capitalizes on the periodic nature of GNSS satellites: their position in the sky is basically repeated every 24 hours. By capturing strategic ephemeris data at specific times over several days, the receiver can predict accurate satellite ephemeris for up to six days after initial reception.

u-blox's AssistNow Autonomous benefits are:

- Faster fix in situations where GNSS satellite signals are weak
- No connectivity required
- Compatible with AssistNow Online and Offline (can work stand-alone, or in tandem with these services)
- No integration effort; calculations are done in the background, transparent to the user.

 For more details, see the u-blox 8 / u-blox M8 Receiver Description including Protocol Specification [3] and the MGA Services User Guide [6].

## 1.7 Augmentation systems

### 1.7.1 Satellite-based augmentation system (SBAS)

The NEO-M8T and LEA-M8T timing receivers optionally support SBAS (including WAAS in the US, EGNOS in Europe, MSAS in Japan and GAGAN in India) to deliver improved location accuracy within the regions covered. However, the additional inter-standard time calibration step used during SBAS reception results in degraded time accuracy overall.

 SBAS reception is disabled by default in NEO-M8T and LEA-M8T.

### 1.7.2 QZSS

The Quasi-Zenith Satellite System (QZSS) is a regional navigation satellite system that transmits additional GPS L1 C/A signals for the Pacific region covering Japan and Australia. The NEO-M8T and LEA-M8T modules are able to receive and track these signals concurrently with GPS signals, resulting

in better availability especially under challenging signal conditions, for example, in urban canyons. The L1- SAIF signal provided by QZSS can be enabled for reception via a GNSS configuration message.

### 1.7.3 IMES

The Japanese Indoor Messaging System (IMES) system is used for indoor position reporting using low-power transmitters which broadcast a GPS-like signal. The NEO-M8T and LEA-M8T modules can be configured to receive and demodulate the signal to provide an in-door location estimate.

 This service is authorized and available only in Japan.

 IMES reception is disabled by default

### 1.7.4 Differential GPS (D-GPS)

The use of differential GPS data improves GPS position accuracy using real-time data from a nearby reference receiver or network. D-GPS starts on receipt of valid data according RTCM 10402.3: “Recommended Standards for Differential GNSS”. RTCM cannot be used together with SBAS and is applicable only to GPS signals in the NEO-M8T and LEA-M8T. The RTCM implementation supports the following RTCM 2.3 messages:

Message type	Description
1	Differential GPS corrections
2	Delta differential GPS corrections
3	GPS reference station parameters
9	GPS partial correction set

**Table 3: Supported RTCM 2.3 messages**

 For more details, see the u-blox 8 / u-blox M8 Receiver Description including Protocol Specification [\[3\]](#).

## 1.8 Precision timing, raw data and low duty-cycle operation

### 1.8.1 Time mode

The NEO-M8T and LEA-M8T support:

- a special fixed-position mode improving timing stability in stationary applications
- optional single-SV time tracking for difficult RF environments (available in fixed-position mode only)
- receiver autonomous integrity monitoring (RAIM) indication for timing
- dual configurable 0.25 Hz to 10 MHz time-pulse outputs

Improved timing performance can be delivered by using the fixed-position mode in stationary applications. In this mode, positioning uncertainties are eliminated from the calculation of time which reduces the error and variation in the phase of the TIMEPULSE signal outputs. The known position also reduces the minimum number of measurements and hence good satellite signals required to enable RAIM, reported in message UBX-TIM-TP.

Operation with as few as one single satellite signal is supported in this mode, enabling continuity of timing in situations with extremely limited sky view. The minimum number of signals required may be increased using message UBX-CFG-NAVX5.

Fixed-position mode is configured with the message CFG-TMODE2 according to Table 4 below either by initiating a survey-in process (which can take some time to complete accurately) or by entering the position of the antenna if known. The survey-in process may be performed during discontinuous

(on/off low duty-cycle) operation if necessary. In this case the receiver should be allowed to make several fixes during each cycle to avoid excessive degradation of the survey-in accuracy.

Time mode settings	Description
Disabled	Standard PVT operation
Survey-in	The receiver computes the average position over an extended time period until a predefined standard deviation has been reached and the minimum observation time has passed by. Afterwards the receiver will be automatically set to fixed mode and the timing features will be activated. Progress during survey-in can be monitored using the TIM-SVIN message.
Fixed mode	Fixed mode is initiated automatically at the completion of a survey-in process or when the receiver is configured with its 3D position (and standard deviation of uncertainty). Fixed position coordinates can be entered in ECEF (Earth Center Earth fixed format) or as latitude, longitude and height.

**Table 4: Time mode settings**

A constellation-specific variant of Universal Coordinated Time (UTC) is used as the receiver's basis for conversion from native GNSS time to UTC. The selection is explicitly specified in message CFG-NAV5. This is significant when the time-pulse output has been configured (CFG-TP5) to be aligned with UTC rather than a GNSS time. In this case, a version of UTC should be selected in CFG-NAV5 of which the receiver has knowledge (from aiding messages or from the GNSS signals themselves). Other selections may result in relatively large timing uncertainties until the offset between GNSS time and the selected UTC becomes available (from satellite signals or aiding messages).

 For more information, see the u-blox 8 /u-blox M8 Receiver Description including Protocol Specification [3].

## 1.8.2 Timepulse and frequency outputs

The NEO-M8T and LEA-M8T modules provide two time pulse outputs that can be configured in rate from 0.25 Hz up to 10 MHz by message CFG-TP5. Time pulse alignment can be configured to UTC or GNSS time according to the standard used in signals being received or to an alternate standard where inter-standard calibration data is available (from the signals themselves or by aiding). The time pulses are generated on edges of an asynchronous clock; for pulse rates below 2 Hz, the exact phase of the TIMEPULSE output is reported before each pulse in the TIM-TP message.

 Times reported in navigation messages such as NAV-PVT report the time of the preceding pulse.

## 1.8.3 Time mark

The NEO-M8T and LEA-M8T modules can be used for precise time measurements with sub-microsecond resolution using the external interrupt pins (**EXTINT0** and **EXTINT1**). Rising and falling edges of these signals are time-stamped to GNSS or UTC time, counted and the results reported in message TIM-TM2. The reference time is the same as set for TIMEPULSE with CFG-TP5.

 For more information, see the u-blox 8 / u-blox M8 Receiver Description including Protocol Specification [3].

## 1.8.4 Timing integrity and availability

The NEO-M8T and LEA-M8T modules include the following measures to support applications requiring excellent timing integrity:

- Time uncertainty estimation:  
The receiver estimates the uncertainty of the time-pulse and time report based on the observed signal characteristics. The time and uncertainties are reported together for each standards-specific time-base in NAV-TIME messages. Under poor signal conditions the estimate of

uncertainty may include unresolved ambiguities; for example, for GPS these might be epoch (millisecond), bit (20 ms) and sub-frame (6 s). Where the output time-base standard is derived from a different constellation (for example, GPS-time from GLONASS), the estimate of uncertainty includes inter-constellation offset uncertainties. The estimate of uncertainty is used to disable or modify the time-pulse output by comparison with the “tAcc” parameter (after conversion to distance) configured in message CFG-NAV5.

- Multi-GNSS signal reception:  
Particularly where sky views are limited, the timing accuracy is improved by combining measurements from two constellations. Inter-GNSS timing offsets are derived locally by the receiver whenever a timing fix can be achieved independently from each constellation (locally derived offsets automatically account for antenna, filter and cable dispersion). These offsets are then used for subsequent combined fixes. Where inter-GNSS offsets cannot be derived locally, offsets broadcast by the constellation satellites are used where available.
- Fix redundancy (RAIM):  
The receiver automatically and continually adjusts the significance of individual signal measurements in the reported estimate of time according to its quality and consistency. This ensures that the integrity of the reported time is protected from individual faulty signals or measurements so long as there are more signals in use than the minimum required. The minimum number changes depending on the situation but whenever it is exceeded “RAIM active” is set in message TIM-TP to indicate that this protection is active.
- Aiding:  
While a GNSS receiver may be able to achieve a vernier (sub-microsecond) time-fix even under poor signal conditions, it may be slow or unable to resolve higher order ambiguities (especially whole milliseconds for GPS). Sub-millisecond time aiding may be applied to u-blox NEO-M8T and LEA-M8T modules by means of a pulse to one of the EXTINT pins in conjunction with a MGA-INI-TIME message, enabling immediate resolution of ambiguities as well as accelerating time to fix.

### 1.8.5 Raw data

The NEO/LEA-M8T modules provide raw measurement data for civil L1 band GPS, GLONASS and BeiDou signals including pseudo-range and carrier phase, Doppler and message payloads. The data contained in the RXM-RAWX message follows the conventions of a multi-GNSS RINEX 3 observation file and includes pseudo-range, carrier phase and Doppler measurements along with measurement quality data. The RXM-SFRBX message provides the demodulated, parity-checked navigation and signaling message bits for each satellite currently tracked by the receiver including GPS, GLONASS and BeiDou constellations, SBAS satellites, the QZSS L1S signal and IMES beacons.

Raw measurement data are available once the receiver has established data bit synchronization and time-of-week. Message data are available for all signals tracked at a sufficient level to achieve data bit and frame synchronization. For more information, see the u-blox 8 / M8 Receiver Description including Protocol Specification [\[3\]](#).

### 1.8.6 Low duty-cycle operation

The NEO-M8T and LEA-M8T low-power timing modules support energy-saving automatic on/off interval low duty-cycle operation in conjunction with their precision timing features. On/off low duty-cycle operation is enabled with the power save mode setting in message CFG-RXM and on/off mode in message CFG-PM2. Through a set of period and time-out parameters defined in the CFG-PM2 message the receiver can be configured to deliver a new time fix at intervals with a limit on total energy consumed for searches if no fix can be achieved. Note that the time-pulse output is not available while the receiver is in the “off” section of each cycle.

The duty-cycle of operation may be reduced significantly by:

- provision of sub-millisecond time-aiding to accelerate ambiguity resolution (see 1.8.4 above),

- provision of ephemeris aiding (message MGA-GPS-EPH) to avoid the need to receive new data transmissions from the satellites themselves.

Survey-in is supported in conjunction with low duty-cycle operation providing the accuracy benefits of a long observation interval without the need to keep the receiver continuously powered. To achieve the best sensitivity on first deployment at a new site, the receiver should be allowed to operate continuously until the first fix is achieved (up to 20 minutes in very poor signal conditions) before engaging low duty cycle operation.

 For more information, see the u-blox 8 / u-blox M8 Receiver Description including Protocol Specification [3].

## 1.9 TIMEPULSE

Two configurable time pulse signals (**TIMEPULSE**, **TIMPULSE2**) are available with u-blox NEO-M8T and LEA-M8T timing modules. The TIMEPULSE outputs generate pulse trains synchronized with GNSS or UTC time grid with intervals configurable over a wide frequency range. Thus it may be used as a low frequency time synchronization pulse or as a high frequency reference signal.

 The TIMEPULSE2 (**TP2**) pin should not be held LO during start-up.

By default the primary time pulse signal is enabled and configured to 1 pulse per second. For more information, see the u-blox 8 / u-blox M8 Receiver Description including Protocol Specification [3].

## 1.10 Odometer

The odometer provides information on the travelled ground distance (in meters) using solely the position and Doppler-based velocity of the navigation solution. For each computed travelled distance since the last odometer reset, the odometer estimates a 1-sigma accuracy value. The total cumulative ground distance is maintained and saved in the BBR memory.

 The odometer feature is disabled by default. For more details, see the u-blox 8 / u-blox M8 Receiver Description including Protocol Specification [3].

## 1.11 Data logging

The u-blox NEO-M8T and LEA-M8T receivers can be used in data logging applications. The data logging feature enables continuous storage of position, velocity and time information to an onboard SQL flash memory. It can also log the distance from the odometer. The information can be downloaded from the receiver later for further analysis or for conversion to a mapping tool. For more information, see the u-blox 8 / u-blox M8 Receiver Description including Protocol Specification [3].

## 1.12 Geofencing

The u-blox NEO-M8T and LEA-M8T modules support up to four circular geofencing areas defined on the Earth's surface using a 2D model. Geofencing is active when at least one geofence is defined, the current status can be found by polling the receiver. A GPIO pin can be nominated to indicate status or wake up a host on activation.

## 1.13 Message integrity protection

The NEO-M8T and LEA-M8T provide a function to detect third party interference with the UBX message stream sent from receiver to host. The security mechanism “signs” nominated messages via a subsequent UBX message. This message signature is then compared with one generated by the host to determine if the message data has been altered.



## 1.14 Spoofing detection

Spoofing is a process whereby a malicious third party tries to control the reported position via a “fake” GNSS broadcast signal. This may result in the form of reporting incorrect position, velocity or time. To combat against this, the NEO-M8T and LEA-M8T modules include spoofing detection measures to alert the host when signals appear to be suspicious. The receiver combines a number of checks on the received signals looking for inconsistencies across several parameters.

## 1.15 EXTINT: External interrupt

The NEO-M8T and LEA-M8T receivers feature two EXTINT pins, each of which can be used to switch the receiver on and off or for aiding.

For more information about how to implement and configure these features, see the u-blox 8 / u-blox M8 Receiver Description including Protocol Specification [3] and the relevant Hardware integration manual [1] or [2].

### 1.15.1 Power control

The power control feature allows overriding the automatic active / inactive cycle of power save mode. The state of the receiver can be controlled through an **EXTINT** pin.

The receiver can also be forced OFF using **EXTINT** when power save mode is not active.

### 1.15.2 Aiding

An **EXTINT** pin can be used to supply time or frequency aiding data to the receiver.

For time aiding, hardware time synchronization can be achieved by connecting an accurate time pulse to the EXTINT pin.

Frequency aiding can be implemented by connecting a periodic rectangular signal with a frequency up to 500 kHz and arbitrary duty cycle (low/high phase duration must not be shorter than 50 ns) to an EXTINT pin. The applied frequency value is provided to the receiver using UBX messages.

 For more information, see the u-blox 8 / u-blox M8 Receiver Description including Protocol Specification [3].

## 1.16 Protocols and interfaces

Protocol	Type
NMEA 0183, version 4.0 (V2.3 or V4.1 configurable)	Input/output, ASCII, 0183, version 4.0
UBX	Input/output, binary, u-blox proprietary
RTCM	Input message, 1, 2, 3, 9

**Table 5: Available protocols**

All protocols are available on UART, USB, DDC (I2C-compliant) and SPI. For specification of the various protocols, see the u-blox 8 / u-blox M8 Receiver Description including Protocol Specification [3].

## 1.17 Interfaces

A number of interfaces are provided for data communication. The embedded firmware uses these interfaces according to their respective protocol specifications.

### 1.17.1 UART

The NEO-M8T and LEA-M8T modules include one UART interface, which can be used for communication to a host. It supports configurable baud rates. For supported baud rates, see the u-blox 8 / u-blox M8 Receiver Description including Protocol Specification [3].

 Designs must allow access to the UART and the **SAFEBOOT\_N** function pin for future service, updates and reconfiguration.

### 1.17.2 USB

USB interface compatible with USB version 2.0 FS (Full Speed, 12 Mbit/s), can be used for communication as an alternative to the UART. The pull-up resistor on pin **USB\_DP** is integrated to signal a full-speed device to the host. The **VDD\_USB** pin supplies the USB interface. The u-blox USB (CDC-ACM) driver supports Windows Vista plus Windows 7 and 8 operating systems. A separate driver (CDC-ACM) is not required for Windows 10 which has a built-in USB-serial driver. However, plugging initially into an internet-connected Windows 10 PC downloads the u-blox combined sensor and VCP driver package.

USB drivers can be down-loaded from the u-blox web site, [www.u-blox.com](http://www.u-blox.com).

### 1.17.3 SPI

The SPI interface is designed to allow communication to a host CPU. The interface can be operated in slave mode only. The maximum transfer rate using SPI is 125 kB/s and the maximum SPI clock frequency is 5.5 MHz (see Figure 5). Note that SPI is not available in the default configuration because its pins are shared with the UART and DDC interfaces. The SPI interface can be enabled by connecting **D\_SEL** (pin 2) to ground (see section 3.1)

### 1.17.4 Display data channel (DDC)

An I2C-compliant DDC interface is available for communication with an external host CPU or u-blox cellular modules. The interface can be operated in slave mode only. The DDC protocol and electrical interface are fully compatible with Fast-Mode of the I2C industry standard. Since the maximum SCL clock frequency is 400 kHz, the maximum transfer rate is 400 kbit/s.

## 1.18 Clock generation

### 1.18.1 Oscillators

The NEO-M8T and LEA-M8T GNSS timing modules incorporate a TCXO for accelerated weak signal acquisition and stable timing output. The TCXO is carefully selected and screened for stability and against frequency perturbations across the full operating range (-40 °C to +85 °C).

### 1.18.2 Real-time clock (RTC) and hardware backup mode

The RTC can be maintained by a secondary 32 kHz oscillator using an RTC crystal. If the main supply voltage is removed, a battery connected to **V\_BCKP** allows the RTC to continue to run with very low power consumption. The same supply also maintains a static backup memory for current configuration information, recent ephemeris, location and auxiliary data necessary to ensure the fastest re-acquisition when the primary power supply is restored.

## 1.19 Power management

u-blox GNSS timing product technology offers a power-optimized architecture with built-in autonomous power saving functions to minimize power consumption at any given time. Furthermore,



the receivers can be used in three operating modes: continuous mode for best performance or one of two power save modes for optimized power consumption. A high-efficiency DC/DC converter is integrated to minimize power consumption and dissipation across the range of supported power supply voltages.

-  For the best GNSS performance, use the power management setup message UBX-CFG-PMS to configure the full power mode.

### 1.19.1 Operating modes

The NEO-M8T and LEA-M8T modules have two operating modes:

- Continuous mode for best GNSS performance
- On/off duty-cycle mode to reduce energy-use in discontinuous operation

-  Timing and raw data features are not fully supported in cyclic power save mode. There is limited support for GLONASS, BeiDou and Galileo signals in on/off duty-cycle mode, notably in efficient reception and use of ephemeris data.

### 1.19.2 Continuous mode

Continuous mode uses the acquisition engine at full performance, resulting in the shortest possible TTFF and the highest sensitivity. It searches for all possible satellites until the Almanac is completely downloaded. The receiver then switches to the tracking engine to lower power consumption.

Thus, a lower tracking current consumption level will be achieved when:

- A valid GNSS position is obtained
- The entire Almanac has been downloaded
- The Ephemeris for each satellite in view is valid

### 1.19.3 On/off interval power save mode

Where an application requires only intermittent navigation or timing information, an on/off low duty-cycle power save mode can be employed. In this mode the receiver starts at intervals configurable between a few seconds and several hours. Alternatively, the receiver can be re-started on demand by a hardware signal applied to either EXTINT input or activity on the UART. An EXTINT pin can also be configured (by CFG-PM2) to define durations when the receiver should be held on or off by hardware control.

With each start, the receiver stays on for long enough to deliver a new fix or download new ephemeris if necessary to make a fix. The receiver makes use of one or more of the following sources of aiding to reduce the duration of each fix and thereby minimize overall energy use:

- built-in RTC (time-aiding) or fine time-aiding delivered to an EXTINT pin (see MGA-INI-TIME messages)
- last known or fixed position (see MGA-INI and CFG-TMODE2 messages)
- ephemeris and auxiliary aiding data messages (see MGA-GPS, MGA-GLO and MGA-BDS messages)

-  On/off duty-cycle power save mode may not provide the minimum energy use when GLONASS, BeiDou or Galileo signal reception is enabled without ephemeris aiding.

-  For more information about power management strategies, see the u-blox 8 / u-blox M8 Receiver Description including Protocol Specification [3].

## 1.20 Antenna

### 1.20.1 Antenna type

The NEO-M8T includes a SAW filter and an additional LNA and is suitable for use with both passive<sup>10</sup> and active<sup>11</sup> antennas. The LEA-M8T includes a SAW filter and is suitable for use with active antennas and antenna distribution systems. Within the recommended range below, lower overall gain can improve immunity to interference in most situations; higher gain offers slightly better sensitivity.

Parameter	Specification	
Antenna type	Passive and active antenna	
Active antenna recommendations	Minimum gain	5 dB (at module input)
	Maximum gain	40 dB <sup>12</sup> (at module input)
	Maximum noise figure	1.5 dB

**Table 6: Antenna specifications**

### 1.20.2 Antenna supervision

The LEA-M8T includes a built-in antenna bias supply for nominal 3 V antennas enabled by linking the filtered **VCC\_RF** supply output pin to the **V\_ANT** antenna supply input pin with a series resistor. The module then controls the power supply to the antenna, applying power whenever the receiver is active and removing power during power-save idle times and if a short-circuit is detected. Short-circuit is detected if the voltage at the antenna supply falls close to zero and is indicated as an alarm in message MON-HW.

Optionally the **EXTINT1** pin may be reassigned to antenna supervision, allowing an external circuit to indicate to the module that the antenna is open-circuit. This condition is then reported in message MON-HW.

The NEO-M8T provides a control output for an external antenna supply switch. Antenna supervision is configurable in both modules using message CFG-ANT.

Antenna supervision is configurable in both modules using message CFG-ANT.

 For more details on antenna supervision in NEO-M8T or LEA-M8T, see the relevant hardware integration manual [1] or [2].

<sup>10</sup> For integration of M8T modules with Cellular products, see the NEO-8Q / NEO-M8 Hardware integration manual [1].

<sup>11</sup> For using active antennas with NEO-M8T modules, see the NEO-8Q / NEO-M8 Hardware integration manual [1].

<sup>12</sup> Gain above 20 dB should be avoided unless interference in the band 1463 MHz to 1710 MHz is adequately controlled.

## 2 Pin definition

### 2.1 NEO-M8T pin assignment

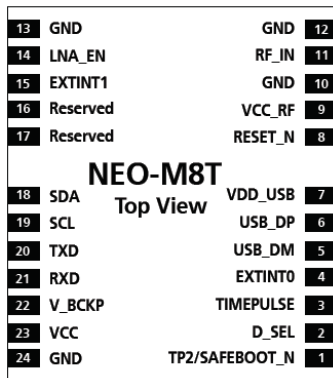

Figure 3: NEO-M8T pin assignment

No	Name	I/O	Description
1	TP2/SAFEBOOT_N	I/O	Timepulse 2 / SAFEBOOT_N (for future service, updates and reconfiguration, must not be held LO during start-up)
2	D_SEL	I	Interface select
3	TIMEPULSE	O	Time pulse (1PPS)
4	EXTINT0	I	External interrupt pin 0
5	USB_DM	I/O	USB data
6	USB_DP	I/O	USB data
7	VDD_USB	I	USB supply
8	RESET_N	I	RESET_N
9	VCC_RF	O	Output voltage RF section
10	GND	I	Ground
11	RF_IN	I	GNSS signal input
12	GND	I	Ground
13	GND	I	Ground
14	LNA_EN <sup>13</sup>	O	Enable external LNA / Antenna control
15	EXTINT1	I	External interrupt pin 1
16	Reserved	-	Reserved
17	Reserved	-	Reserved
18	SDA SPI_CS_N	I/O	DDC data if D_SEL = 1 (or open) SPI chip select if D_SEL = 0
19	SCL SPI_CLK	I/O	DDC clock if D_SEL = 1 (or open) SPI clock if D_SEL = 0
20	TXD SPI_MISO	O	Serial port if D_SEL = 1 (or open) SPI MISO if D_SEL = 0
21	RXD SPI_MOSI	I	Serial port if D_SEL = 1 (or open) SPI MOSI if D_SEL = 0
22	V_BCKP	I	Backup voltage supply
23	VCC	I	Supply voltage
24	GND	I	Ground

Table 7: NEO-M8T pinout

<sup>13</sup> Compatible with pin labelled ANT\_ON in predecessor products

Pins designated Reserved should not be used. For more information about pinouts, see the NEO-8Q / NEO-M8 Hardware integration manual [1].

## 2.2 LEA-M8T pin assignment

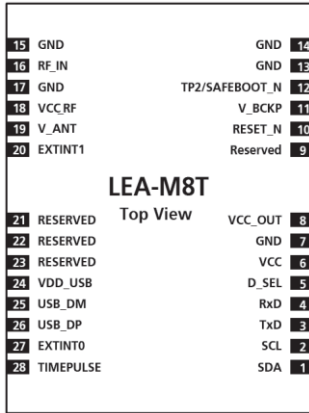



Figure 4: LEA-M8T pin assignment

No	Name	I/O	Description
1	SDA SPI CS_N	I/O	DDC data if D_SEL = 1 (or open) SPI chip select if D_SEL = 0
2	SCL SPI CLK	I/O	DDC clock if D_SEL = 1 (or open) SPI clock if D_SEL = 0
3	TXD SPI MISO	O	Serial port if D_SEL = 1 (or open) SPI MISO if D_SEL = 0
4	RXD SPI MOSI	I	Serial port if D_SEL = 1 (or open) SPI MOSI if D_SEL = 0
5	D_SEL	I	Interface select
6	VCC	I	Supply voltage
7	GND	-	Ground
8	VCC_OUT	O	Output voltage (VCC)
9	Reserved	-	Reserved
10	RESET_N	I	RESET_N
11	V_BCKP	I	Backup voltage supply
12	TP2/SAFEBOOT_N	I/O	Timepulse 2 / SAFEBOOT_N (must not be held LO during start-up)
13	GND	-	Ground
14	GND	-	Ground
15	GND	-	Ground
16	RF_IN	I	GPS signal input
17	GND	-	Ground
18	VCC_RF	O	Output voltage RF section
19	V_ANT	I	Active antenna voltage supply
20	EXTINT1 <sup>14</sup>	I	External interrupt pin 1, can be configured as active antenna open circuit detection pin: ANT_DET_N
21	Reserved	-	Reserved
22	Reserved	-	Reserved
23	Reserved	-	Reserved

<sup>14</sup> Compatible with pin labelled AADET\_N/EXTINT1 in predecessor products

No	Name	I/O	Description
24	VDD_USB	I	USB supply
25	USB_DM	I/O	USB data
26	USB_DP	I/O	USB data
27	EXTINT0	I	External interrupt pin 0
28	TIMEPULSE	O	Timepulse (1 PPS)

**Table 8: LEA-M8T pinout**

 Pins designated Reserved should not be used. For more information about pinouts, see the LEA-M8S / M8T Hardware integration manual [\[2\]](#).

## 3 Configuration management

Configuration settings can be modified with UBX configuration messages. The modified settings remain effective until power-down or reset. Settings can also be saved in battery-backed RAM, flash or both using the UBX-CFG-CFG message. If settings have been stored in battery-backed RAM then the modified configuration will be retained as long as the backup battery supply is not interrupted. Settings stored in flash memory will remain effective even after power-down and do not require backup battery supply.

### 3.1 Interface selection (D\_SEL)

At startup, the **D\_SEL** pin determines which data interfaces are used for communication. If **D\_SEL** is set high or left open, UART and DDC become available. If **D\_SEL** is set low, that is, connected to ground, the modules can communicate to a host via SPI.

PIN NUMBER NEO-M8T	PIN NUMBER LEA-M8T	D_SEL="1" (left open)	D_SEL = "0" (connected to GND)
20	3	UART TX	SPI MISO
21	4	UART RX	SPI MOSI
19	2	DDC SCL	SPI CLK
18	1	DDC SDA	SPI CS_N

**Table 9: Data interface selection by D\_SEL**

## 4 Electrical specification

The limiting values given are in accordance with the Absolute Maximum Rating System (IEC 134). Stress above one or more of the limiting values may cause permanent damage to the device. These are stress ratings only and operation of the device at these or at any other conditions above those given in the characteristics sections of the specification is not implied. Exposure to these limits for extended periods may affect device reliability.

Where application information is given, it is advisory only and does not form part of the specification. For more information, see the NEO-8Q / NEO-M8 Hardware integration manual [1] and the LEA-M8S / M8T Hardware integration manual [2].

### 4.1 Absolute maximum rating

Parameter	Symbol	Module	Condition	Min	Max	Units
Power supply voltage	VCC	All		-0.5	3.6	V
Backup battery voltage	V_BCKP	All		-0.5	3.6	V
USB supply voltage	VDD_USB	All		-0.5	3.6	V
Input pin applied DC voltage	V <sub>in</sub>	All		-0.5	3.6	V
	V <sub>in_usb</sub>	All		-0.5	VDD_USB	V
	V <sub>rfin</sub>	NEO-M8T LEA-M8T <sup>15</sup>		0 -	6 -	V
DC current through any digital I/O pin (except supplies)	I <sub>pin</sub>				10	mA
VCC_RF output current	ICC_RF	All			100	mA
Input power at RF_IN	Pr <sub>fin</sub>	All	source impedance = 50 Ω, continuous wave		13	dBm
Antenna bias voltage	V_ANT				6	V
Antenna bias current	I_ANT				100	mA
Storage temperature	T <sub>stg</sub>	All		-40	85	°C

**Table 10: Absolute maximum ratings**

Stressing the device beyond the “Absolute Maximum Ratings” may cause permanent damage. These are stress ratings only. The product is not protected against overvoltage or reversed voltages. If necessary, voltage spikes exceeding the power supply voltage specification, given in Table 10, must be limited to values within the specified boundaries by using appropriate protection diodes.

<sup>15</sup> Antenna bias is supplied by LEA-M8T module

## 4.2 Operating conditions

All specifications are at an ambient temperature of +25 °C. Extreme operating temperatures can significantly impact specification values. Applications operating near the temperature limits should be tested to ensure the specification.

Parameter	Symbol	Modules	Min	Typical	Max	Units	Condition
Power supply voltage	VCC	All	2.7	3.0	3.6	V	
Supply voltage USB	VDDUSB	All	3.0	3.3	3.6	V	
Backup battery voltage	V_BCKP	All	1.4		3.6	V	
Backup battery current	I_BCKP	NEO-M8T		15		μA	V_BCKP = 1.8 V, VCC = 0 V
		LEA-M8T		17			
SW backup current	I_SWBCKP	NEO-M8T		30		μA	VCC = 3 V
		LEA-M8T		50			
Input pin voltage range	V <sub>in</sub>	All	0		VCC+0.5	V	
Digital IO pin low level input voltage	V <sub>il</sub>	All	0		0.2*VCC	V	
Digital IO pin high level input voltage	V <sub>ih</sub>	All	0.7*VCC		VCC	V	
Digital IO pin low level output voltage	V <sub>ol</sub>	All			0.4	V	I <sub>ol</sub> = 4 mA
Digital IO pin high level output voltage	V <sub>oh</sub>	All	VCC-0.4			V	I <sub>oh</sub> = 4 mA
Pull-up resistor for RESET_N (internal)	R <sub>pu</sub>	All		11		kΩ	
USB_DM, USB_DP	V <sub>inU</sub>	All	Compatible with USB with 27 Ω series resistance				
V_ANT antenna bias voltage	V_ANT	LEA-M8T	2.7		5.5	V	I <sub>ANT</sub> < -50 mA
Antenna bias voltage drop	V_ANT_DROP	LEA-M8T		0.1		V	ICC_RF = 50 mA
VCC_RF voltage	VCC_RF	All		VCC-0.1		V	
VCC_RF output current	ICC_RF	All			50	mA	
Receiver chain noise figure <sup>16</sup>	NF <sub>tot</sub>	NEO-M8T		2.0		dB	
		LEA-M8T		4.7			
Operating temperature	T <sub>opr</sub>	All	-40		85	°C	

**Table 11: Operating conditions**

Operation beyond the specified operating conditions can affect device reliability.

## 4.3 Indicative current requirements

Table 12 lists examples of the total system supply current for a possible application.

Values in [Table 12](#) are provided for customer information only as an example of typical power requirements. Values are characterized on samples, actual power requirements can vary depending on FW version used, external circuitry, number of SVs tracked, signal strength, type of start as well as time, duration and conditions of test.

Parameter	Symbol	Module	Typ.		Max	Units	Condition
			GPS	GPS/GLONASS/QZSS/SBAS			
Max. supply current <sup>17</sup>	I <sub>ccp</sub>	All			67	mA	
Average supply current <sup>18</sup>	I <sub>cc</sub>	NEO-M8T	25	32		mA	Estimated at 3 V
		LEA-M8T	21	28		mA	

**Table 12: Indicative power requirements at VCC = 3.0 V**

<sup>16</sup> Only valid for the GPS band

<sup>17</sup> Use this figure to dimension maximum current capability of power supply. Measure this parameter with 1 Hz bandwidth.

<sup>18</sup> Simulated GNSS constellation using power levels of -130 dBm. VCC = 3.0 V Use to determine required battery capacity.



- For more information about power requirements, see the relevant M8T Hardware integration manual [1] or [2].
- For more information on how to noticeably reduce current consumption, see the Power Management Application Note [5].

## 4.4 SPI timing diagrams

In order to avoid incorrect operation of the SPI, the user needs to comply with certain timing conditions. The following signals need to be considered for timing constraints:

Symbol	Description
SPI CS_N (SS_N)	Slave select signal
SPI CLK (SCK)	Slave clock signal

Table 13: Symbol description

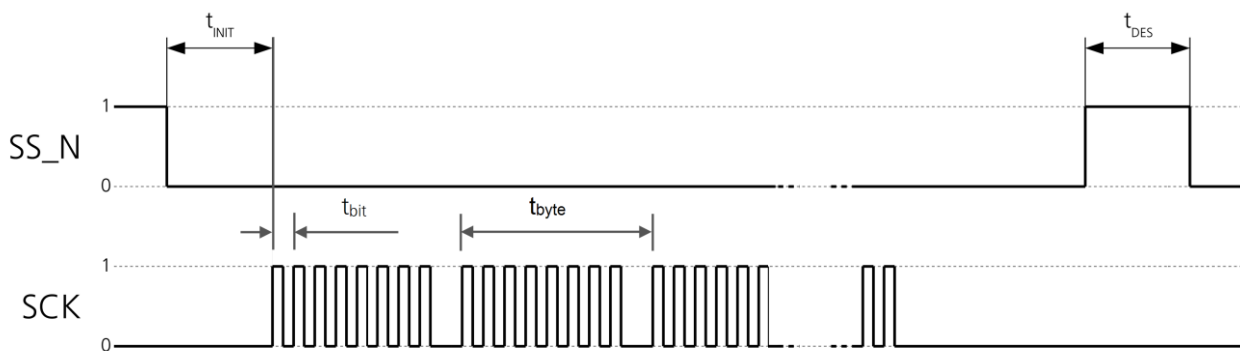

Figure 5: SPI timing diagram

### 4.4.1 Timing recommendations

The recommendations below are based on a firmware running from flash memory.

Parameter	Description	Recommendation
$t_{INIT}$	Initialization time	>10 $\mu$ s
$t_{DES}$	Deselect time	1 ms.
$t_{bit}$	Minimum bit time	180 ns (5.5 MHz max bit frequency)
$t_{byte}$	Minimum byte period	8 $\mu$ s (125 kHz max byte frequency)

Table 14: SPI timing recommendations

- The values in Table 14 result from the requirement of an error-free transmission. By allowing just a few errors and disabling the glitch filter, the bit rate can be increased considerably.

## 4.5 DDC timing diagrams

The DDC interface is I2C Fast Mode compliant. For timing parameters consult the I2C standard.

- The maximum bit rate is 400 kbit/s. The interface stretches the clock when slowed down when serving interrupts, so real bit rates may be slightly lower.

## 5 Mechanical specifications

### 5.1 NEO-M8T

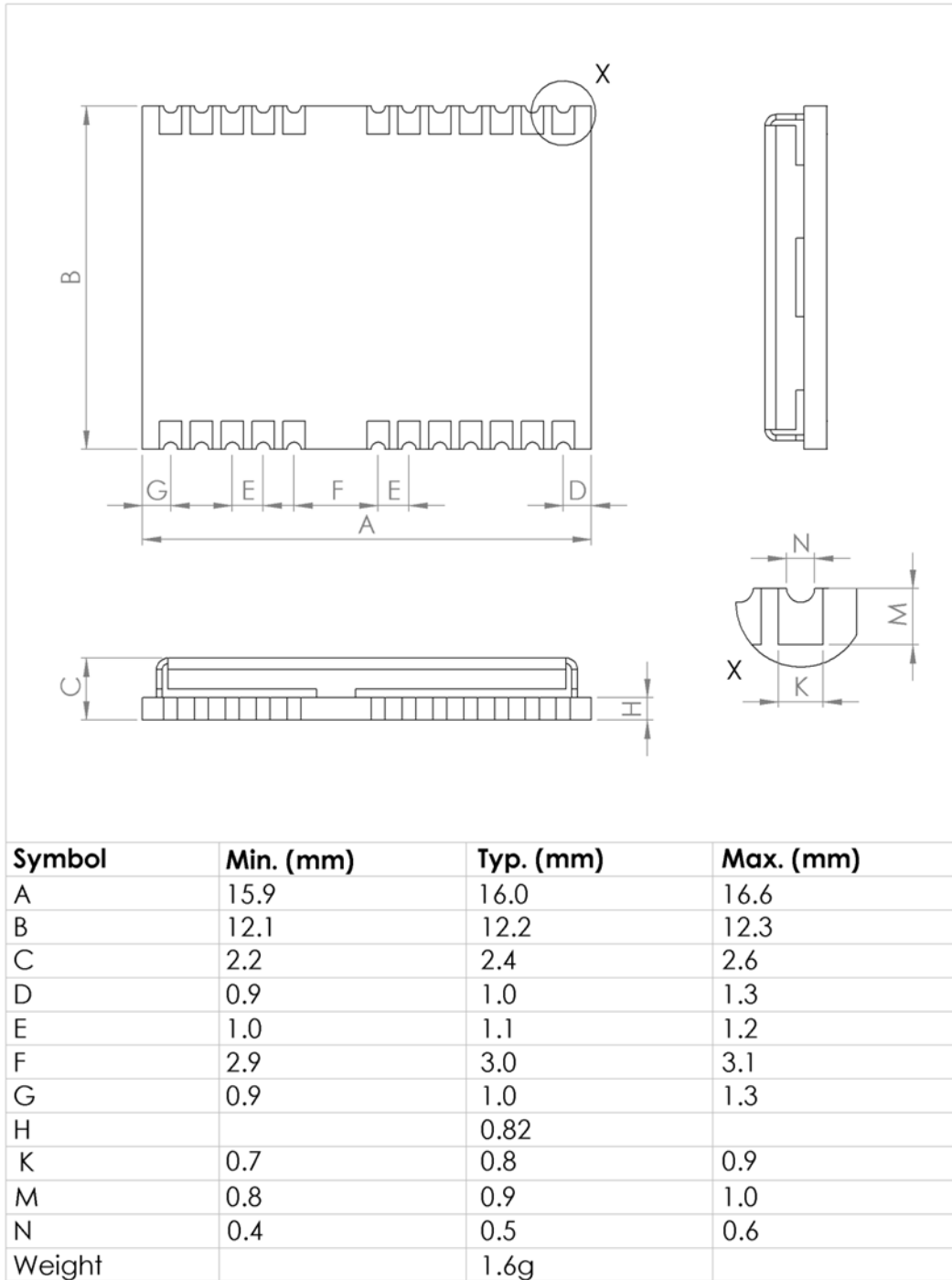

Figure 6: NEO dimensions

For information about the paste mask and footprint, see the NEO-8Q / NEO-M8 Hardware integration manual [1].

## 5.2 LEA-M8T

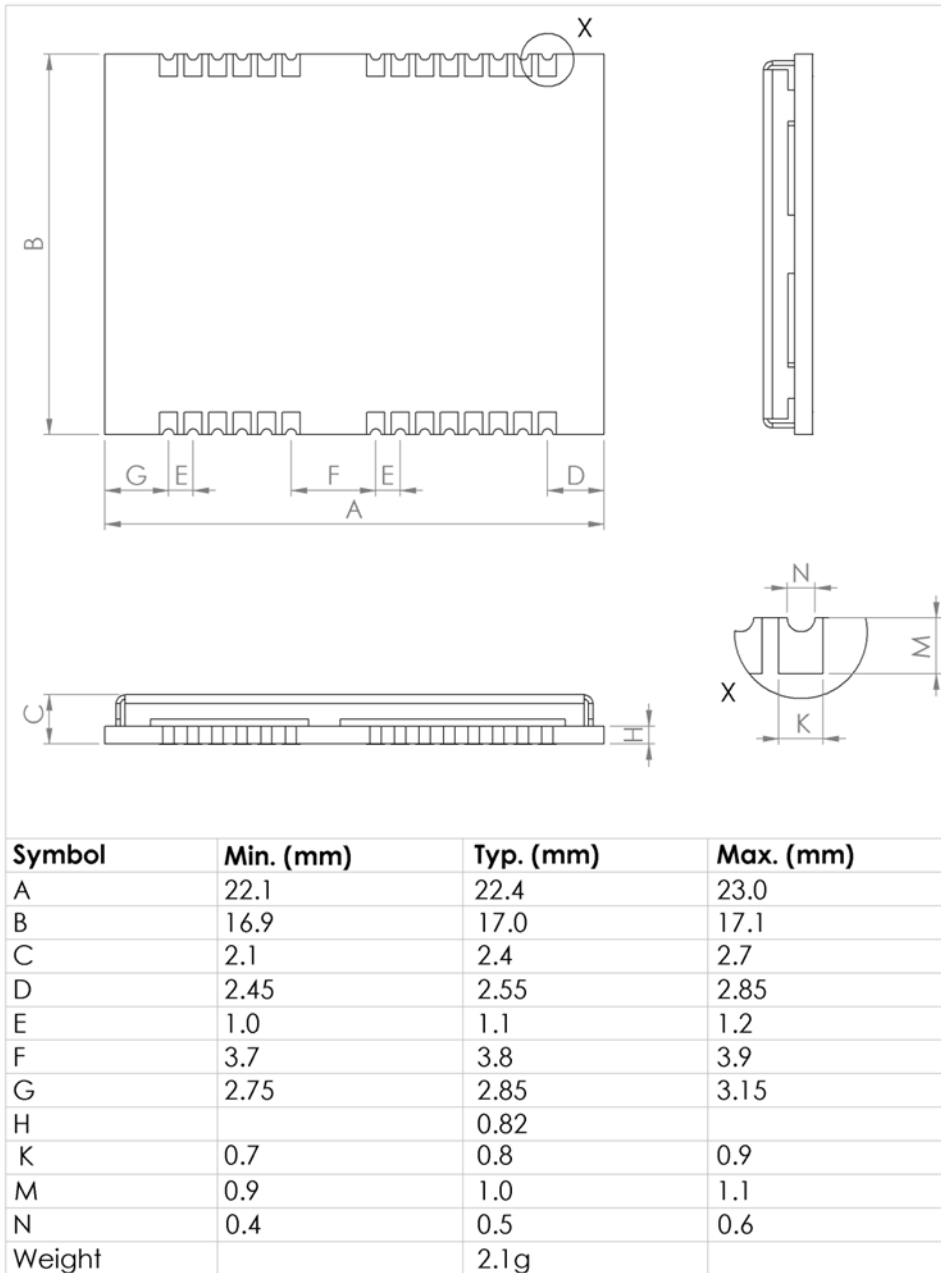



Figure 7: LEA dimensions

For information about the paste mask and footprint, see the LEA-M8S / M8T Hardware integration manual [2].

## 6 Reliability tests and approvals

### 6.1 Reliability tests

 The NEO-M8T and LEA-M8T modules are based on AEC-Q100 qualified GNSS chips.

Tests for product family qualifications are according to ISO 16750 "Road vehicles – environmental conditions and testing for electrical and electronic equipment", and appropriate standards.

### 6.2 Approvals



Products marked with this lead-free symbol on the product label comply with the "Directive 2002/95/EC of the European Parliament and the Council on the Restriction of Use of certain Hazardous Substances in Electrical and Electronic Equipment" (RoHS).

All u-blox M8 GNSS modules are RoHS compliant.

## 7 Product handling and soldering

### 7.1 Packaging

To enable efficient production, production lot set-up and tear-down, NEO-M8T and LEA-M8T GNSS modules are delivered as hermetically sealed, reeled tapes. For more information, see the u-blox Package Information Guide [4].

#### 7.1.1 Reels

NEO-M8T and LEA-M8T GNSS modules are both deliverable in quantities of 250 pcs on a reel. NEO-M8T and LEA-M8T receivers are shipped on reel type B, as specified in the u-blox Package Information Guide [4].

#### 7.1.2 NEO-M8T tapes

The dimensions and orientations of the tapes for NEO-M8T modules are specified in Figure 8.

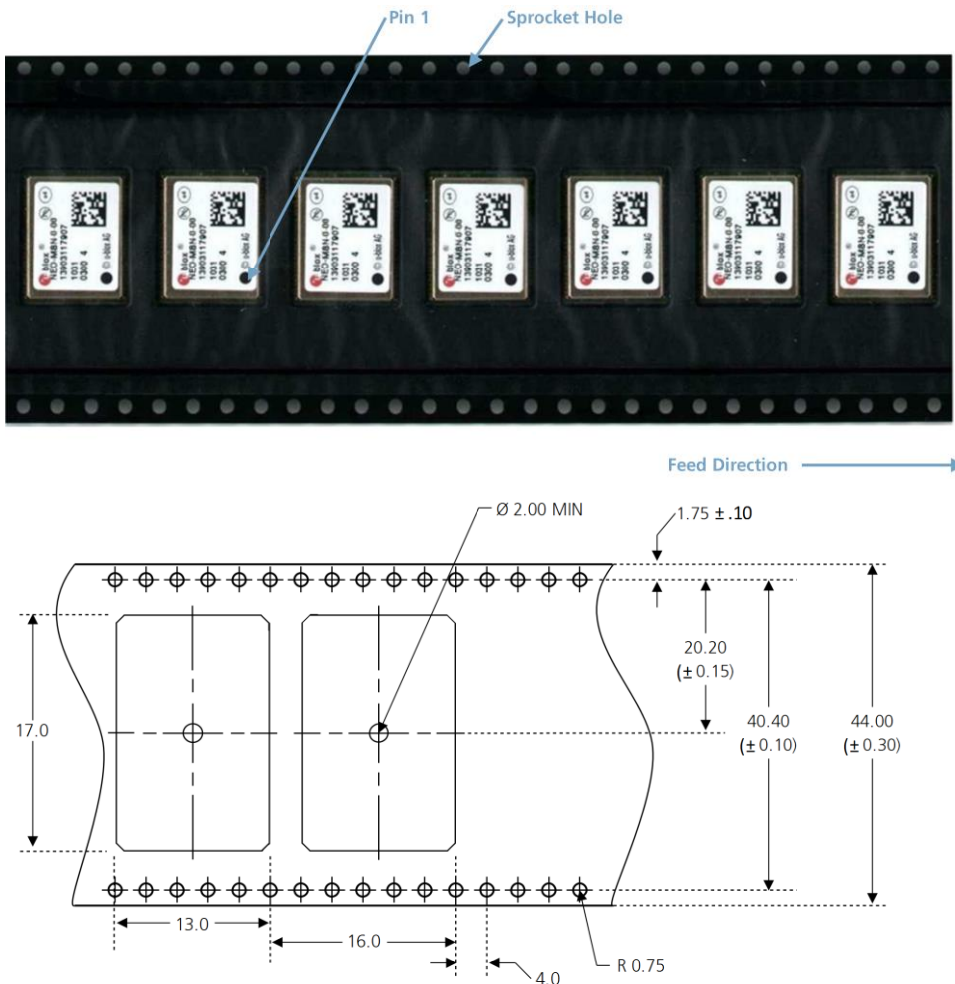

Figure 8: Dimensions and orientation for NEO-M8T modules on tape

### 7.1.3 LEA-M8T tapes

The dimensions and orientations of the tapes for LEA-M8T modules are specified in Figure 9.

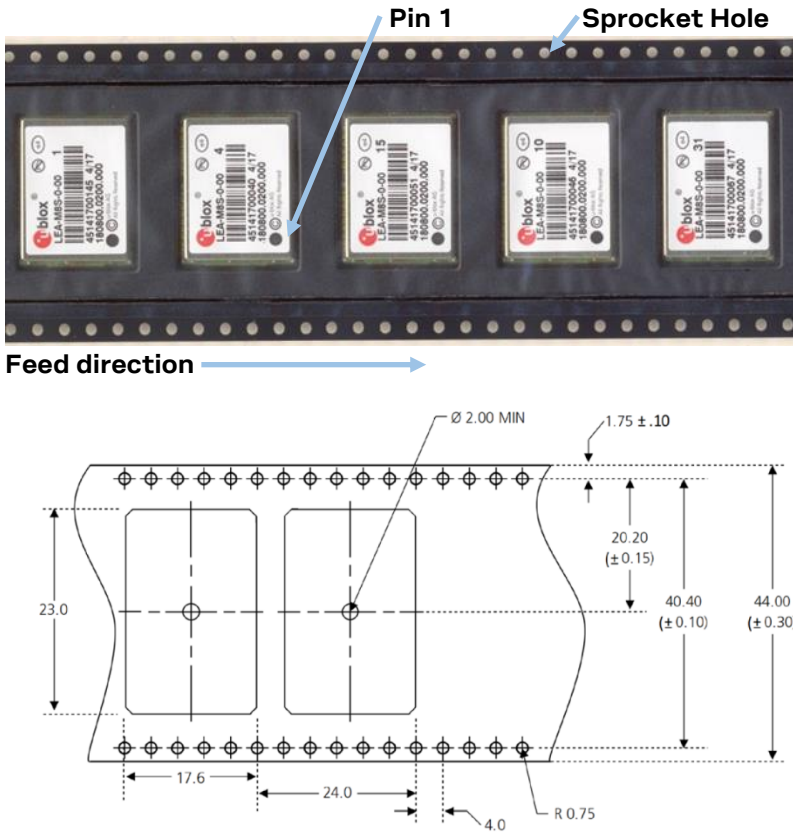

Figure 9: Dimensions and orientation for LEA-M8T modules on tape

## 7.2 Shipment, storage and handling

For important information regarding shipment, storage and handling, see the u-blox Package Information Guide [4].

### 7.2.1 Moisture sensitivity levels

The moisture sensitivity level (MSL) relates to the packaging and handling precautions required. NEO-M8T and LEA-M8T modules are rated at MSL level 4.

For MSL standard see IPC/JEDEC J-STD-020, which can be downloaded from [www.jedec.org](http://www.jedec.org).

For more information regarding MSL, see the u-blox Package Information Guide [4].

### 7.2.2 Reflow soldering

Reflow profiles are to be selected according u-blox recommendations (see the relevant Hardware integration manual [1] or [2]).

### 7.2.3 ESD handling precautions

 NEO-M8T and LEA-M8T modules are electrostatic sensitive devices (ESD). Observe precautions for handling! Failure to observe these precautions can result in severe damage to the GNSS receiver!

GNSS receivers are electrostatic sensitive devices (ESD) and require special precautions when handling. Particular care must be exercised when handling patch antennas, due to the risk of electrostatic charges. In addition to standard ESD safety practices, the following measures should be taken into account whenever handling the receiver:

- Unless there is a galvanic coupling between the local GND (i.e. the work table) and the PCB GND, the first point of contact when handling the PCB must always be between the local GND and PCB GND.
- Before mounting an antenna patch, connect the ground of the device.
- When handling the RF pin, do not come into contact with any charged capacitors and be careful when contacting materials that can develop charges (e.g. patch antenna ~10 pF, coax cable ~50-80 pF/m, soldering iron).
- To prevent electrostatic discharge through the RF input, do not touch any exposed antenna area. If there is any risk that such exposed antenna area is touched in a non-ESD protected work area, implement proper ESD protection measures in the design.
- When soldering RF connectors and patch antennas to the receiver's RF pin, make sure to use an ESD safe soldering iron (tip).

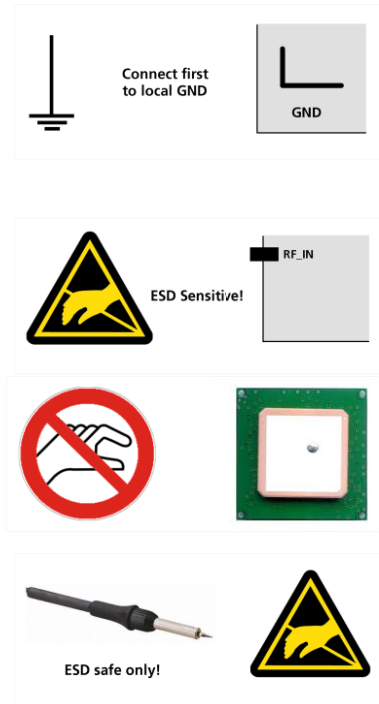

## 8 Default messages

Interface	Settings
UART output	9600 baud, 8 bits, no parity bit, 1 stop bit Configured to transmit both NMEA and UBX protocols, but only the following NMEA (and no UBX) messages have been activated at start-up: <b>GGA, GLL, GSA, GSV, RMC, VTG, TXT, ZDA</b>
USB output	Configured to transmit both NMEA and UBX protocols, but only the following NMEA (and no UBX) messages have been activated at start-up: <b>GGA, GLL, GSA, GSV, RMC, VTG, TXT, ZDA</b> USB power mode: Bus-powered
UART input	9600 baud, 8 bits, no parity bit, 1 stop bit, autobauding disabled Automatically accepts following protocols without need of explicit configuration: UBX, NMEA, RTCM The GNSS receiver supports interleaved UBX and NMEA messages.
USB input	Automatically accepts following protocols without need of explicit configuration: UBX, NMEA The GPS receiver supports interleaved UBX and NMEA messages. USB power mode: Bus-powered
DDC	Fully compatible with the I2C industry standard, available for communication with an external host CPU or u-blox cellular modules, operated in slave mode only. Default messages activated. NMEA and UBX are enabled as input messages, only NMEA as output messages. Maximum bit rate 400 kbit/s.
SPI	Allow communication to a host CPU, operated in slave mode only. Default messages activated. SPI is not available in the default configuration.
TIMEPULSE (1 Hz Nav)	1 pulse per second, synchronized at rising edge, pulse length 100 ms

**Table 15: Default messages**

 Refer to the u-blox 8 / u-blox M8 Receiver Description including Protocol Specification [\[3\]](#) for information about other settings.



## 9 Labeling and ordering information

### 9.1 NEO-M8T product labeling

The labeling of u-blox M8 GNSS modules includes important product information. The location of the NEO-M8T product type number is shown in Figure 10.

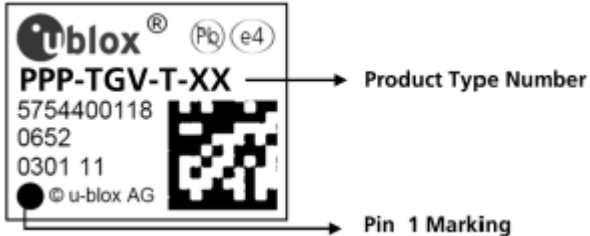

Figure 10: Location of product type number on u-blox NEO-M8T module label

### 9.2 LEA-M8T product labeling

The labeling of u-blox M8 GNSS modules includes important product information. The location of the LEA-M8T product type number is shown in Figure 11.

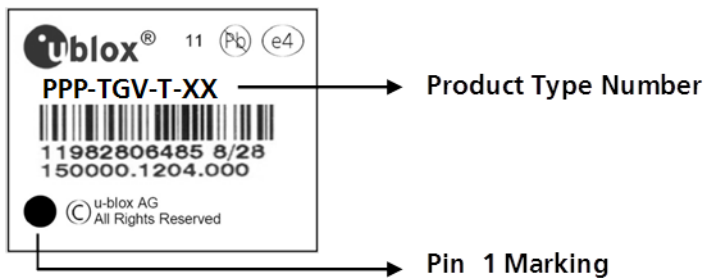

Figure 11: Location of product type number on u-blox LEA-M8T module label

## 9.3 Explanation of codes

Three different product code formats are used. The **Product Name** is used in documentation such as this data sheet and identifies all u-blox M8 products, independent of packaging and quality grade. The **Ordering Code** includes options and quality, while the **Type Number** includes the hardware and firmware versions. Table 16 shows the structure of these three different formats.

Format	Structure
Product Name	PPP-TGV
Ordering Code	PPP-TGV-T
Type Number	PPP-TGV-T-XX

**Table 16: Product code formats**

The parts of the product code are explained in Table 17.

Code	Meaning	Example
PPP	Product family	NEO
TG	Platform	M8 = u-blox M8
V	Variant	Function set (A-Z), T = Timing, R = DR, etc.
T	Option / Quality grade	Describes standardized functional element or quality grade 0 = Default variant, A = Automotive
XX	Product detail	Describes product details or options such as hard- and software revision, cable length, etc.

**Table 17: Part identification code**

## 9.4 Ordering codes

Ordering code	Product
LEA-M8T-0	u-blox M8 GNSS Module, Timing, TCXO, flash, SAW, 17x22.4 mm, 250 pieces/reel
NEO-M8T-0	u-blox M8 GNSS Module, Timing, TCXO, flash, SAW, LNA, 12.2x16 mm, 250 pieces/reel

**Table 18: Product ordering codes**

 Product changes affecting form, fit or function are documented by u-blox. For a list of Product Change Notifications (PCNs), see our website.

## Related documents

- [1] NEO-8Q / NEO-M8 Hardware integration manual, UBX-15029985
- [2] LEA-M8S / LEA-M8T Hardware integration manual, UBX-15030060
- [3] u-blox 8 / u-blox M8 Receiver Description including Protocol Specification, UBX 13003221
- [4] u-blox Package Information Guide, UBX-14001652
- [5] Power Management Application Note, UBX-13005162
- [6] MGA Services User Guide, UBX-13004360

 For regular updates to u-blox documentation and to receive product change notifications, register on our homepage ([www.u-blox.com](http://www.u-blox.com)).

## Revision history

Revision	Date	Name	Comments
R01	28-Oct-2015	amil	Objective Specification
R02	03-May-2016	amil	Advance Information
R03	21-Jun-2016	amil	Production Information, minor update in Table 1 and Table 8, removed reference to message UBX-CFG-TM2
R04	05-May-2020	ghun, smos, dama	Corrected NEO-M8T V <sub>rfin</sub> maximum input voltage to 6V in Table 10. Corrected invalid references. Rebranding. Editorial changes to reflect the latest company style guide changes. Updated document information section for LEA-M8T-1-00 product.

# Contact

For complete contact information, visit us at [www.u-blox.com](http://www.u-blox.com).

## u-blox Offices

### North, Central and South America

#### u-blox America, Inc.

Phone: +1 703 483 3180  
E-mail: [info\\_us@u-blox.com](mailto:info_us@u-blox.com)

#### Regional Office West Coast:

Phone: +1 408 573 3640  
E-mail: [info\\_us@u-blox.com](mailto:info_us@u-blox.com)

#### Technical Support:

Phone: +1 703 483 3185  
E-mail: [support@u-blox.com](mailto:support@u-blox.com)

### Headquarters

#### Europe, Middle East, Africa

#### u-blox AG

Phone: +41 44 722 74 44  
E-mail: [info@u-blox.com](mailto:info@u-blox.com)  
Support: [support@u-blox.com](mailto:support@u-blox.com)

### Asia, Australia, Pacific

#### u-blox Singapore Pte. Ltd.

Phone: +65 6734 3811  
E-mail: [info\\_ap@u-blox.com](mailto:info_ap@u-blox.com)  
Support: [support\\_ap@u-blox.com](mailto:support_ap@u-blox.com)

#### Regional Office Australia:

Phone: +61 2 8448 2016  
E-mail: [info\\_anz@u-blox.com](mailto:info_anz@u-blox.com)  
Support: [support\\_ap@u-blox.com](mailto:support_ap@u-blox.com)

#### Regional Office China (Beijing):

Phone: +86 10 68 133 545  
E-mail: [info\\_cn@u-blox.com](mailto:info_cn@u-blox.com)  
Support: [support\\_cn@u-blox.com](mailto:support_cn@u-blox.com)

#### Regional Office China (Chongqing):

Phone: +86 23 6815 1588  
E-mail: [info\\_cn@u-blox.com](mailto:info_cn@u-blox.com)  
Support: [support\\_cn@u-blox.com](mailto:support_cn@u-blox.com)

#### Regional Office China (Shanghai):

Phone: +86 21 6090 4832  
E-mail: [info\\_cn@u-blox.com](mailto:info_cn@u-blox.com)  
Support: [support\\_cn@u-blox.com](mailto:support_cn@u-blox.com)

#### Regional Office China (Shenzhen):

Phone: +86 755 8627 1083  
E-mail: [info\\_cn@u-blox.com](mailto:info_cn@u-blox.com)  
Support: [support\\_cn@u-blox.com](mailto:support_cn@u-blox.com)

#### Regional Office India:

Phone: +91 80 405 092 00  
E-mail: [info\\_in@u-blox.com](mailto:info_in@u-blox.com)  
Support: [support\\_in@u-blox.com](mailto:support_in@u-blox.com)

#### Regional Office Japan (Osaka):

Phone: +81 6 6941 3660  
E-mail: [info\\_jp@u-blox.com](mailto:info_jp@u-blox.com)  
Support: [support\\_jp@u-blox.com](mailto:support_jp@u-blox.com)

#### Regional Office Japan (Tokyo):

Phone: +81 3 5775 3850  
E-mail: [info\\_jp@u-blox.com](mailto:info_jp@u-blox.com)  
Support: [support\\_jp@u-blox.com](mailto:support_jp@u-blox.com)

#### Regional Office Korea:

Phone: +82 2 542 0861  
E-mail: [info\\_kr@u-blox.com](mailto:info_kr@u-blox.com)  
Support: [support\\_kr@u-blox.com](mailto:support_kr@u-blox.com)

#### Regional Office Taiwan:

Phone: +886 2 2657 1090  
E-mail: [info\\_tw@u-blox.com](mailto:info_tw@u-blox.com)  
Support: [support\\_tw@u-blox.com](mailto:support_tw@u-blox.com)