

## Single Phase Rectifier Bridge, 3 A, 6 A

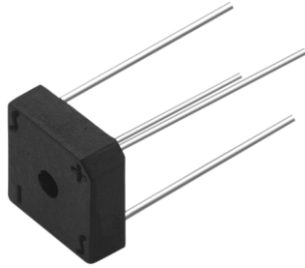

D-72

### FEATURES

- Suitable for printed circuit board or chassis mounting
- Compact construction
- High surge current capability
- Compliant to RoHS directive 2002/95/EC



**RoHS**  
COMPLIANT

### DESCRIPTION

The KBPC series of single phase rectifier bridge consists of four silicon junctions connected as a full bridge. These devices are intended for general use in industrial and consumer equipment.

### PRODUCT SUMMARY

$I_{O(AV)}$	3.0 A, 6.0 A
$V_{RRM}$	50 V to 1000 V

### MAJOR RATINGS AND CHARACTERISTICS

SYMBOL	CHARACTERISTICS	KBPC1	KBPC6	UNITS
$I_O$		3	6	A
$I_{FSM}$	50 Hz	50	125	A
	60 Hz	55	137	
$I^2t$	50 Hz	12.5	78	A <sup>2</sup> s
	60 Hz	11.4	71	
$V_{RRM}$	Range	50 to 1000		V
$T_J$		- 40 to 150		°C

### ELECTRICAL SPECIFICATIONS

#### VOLTAGE RATINGS

PART NUMBER		$V_{RRM}$ , MAXIMUM REPETITIVE PEAK REVERSE VOLTAGE V	$V_{RSM}$ , MAXIMUM NON-REPETITIVE PEAK REVERSE VOLTAGE V	$V_{RMS}$ , MAXIMUM RECOMMENDED RMS SUPPLY VOLTAGE V
KBPC1005	KBPC6005	50	50	20
KBPC102	KBPC602	200	200	80
KBPC104	KBPC604	400	400	125
KBPC106	KBPC606	600	600	250
KBPC108	KBPC608	800	800	380
KBPC110	KBPC610	1000	1000	500

# KBPC1, KBPC6 Series



Vishay High Power Products Single Phase Rectifier  
Bridge, 3 A, 6 A

FORWARD CONDUCTION						
PARAMETER	SYMBOL	TEST CONDITIONS		KBPC1	KBPC6	UNITS
Maximum DC output current	$I_O$	$T_C = 50\text{ }^\circ\text{C}$ , resistive or inductive load		3.0	6.0	A
		$T_C = 50\text{ }^\circ\text{C}$ , capacitive load		2.4	4.7	
Maximum peak one cycle, non-repetitive surge current	$I_{FSM}$	$t = 10\text{ ms}$ , 20 ms	Following any rated load condition and with rated $V_{RRM}$ reapplied	50	125	A
		$t = 8.3\text{ ms}$ , 16.7 ms		55	137	
Maximum $I^2t$ capability for fusing	$I^2t$	$t = 10\text{ ms}$	Initial $T_J = T_J$ maximum 100 % $V_{RRM}$ reapplied	12.5	78	$A^2s$
		$t = 8.3\text{ ms}$		11.4	71	
		$t = 10\text{ ms}$		17.7	110	
		$t = 8.3\text{ ms}$		16.1	1000	
Maximum $I^2\sqrt{t}$ capability for fusing	$I^2\sqrt{t}$	$t = 0.1\text{ ms}$ to 10 ms, no voltage reapplied		177	1105	$A^2\sqrt{s}$
Maximum peak forward voltage per diode	$V_{FM}$	$I_{FM} = 0.5 \times I_O$ , $T_J = 25\text{ }^\circ\text{C}$		1.1	1.2	V
Typical peak reverse leakage per diode	$I_{RM}$	$T_J = 25\text{ }^\circ\text{C}$ , 100 % $V_{RRM}$		10	10	mA
		$T_J = 150\text{ }^\circ\text{C}$ , 100 % $V_{RRM}$		1.0	1.0	
Operating frequency range	$f$			40 to 1000		Hz
Maximum repetitive peak reverse voltage range	$V_{RRM}$			50 to 1000		V

THERMAL AND MECHANICAL SPECIFICATIONS				
PARAMETER	SYMBOL	KBPC1	KBPC6	UNITS
Operating and storage temperature range	$T_J$ , $T_{Stg}$	- 40 to 150		$^\circ\text{C}$
Thermal resistance, junction to case	$R_{thJC}$	-	-	K/W
Approximate weight		5	6	g
		0.18	0.21	oz.

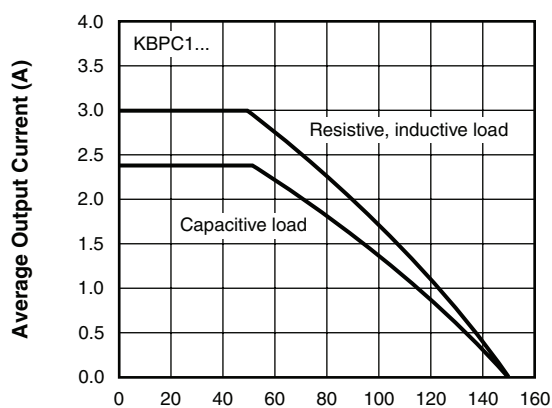

93585\_01 Maximum Allowable Case Temperature ( $^\circ\text{C}$ )

Fig. 1 - Case Temperature Ratings

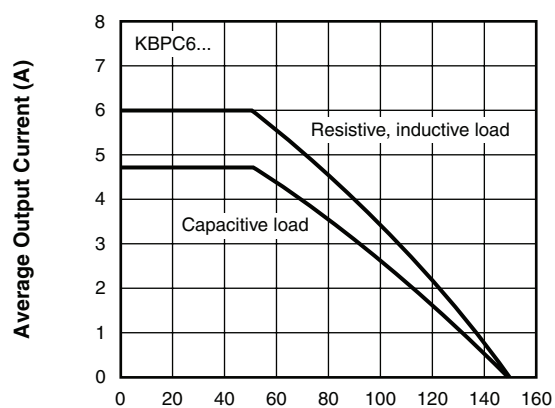

93585\_02 Maximum Allowable Case Temperature ( $^\circ\text{C}$ )

Fig. 2 - Case Temperature Ratings

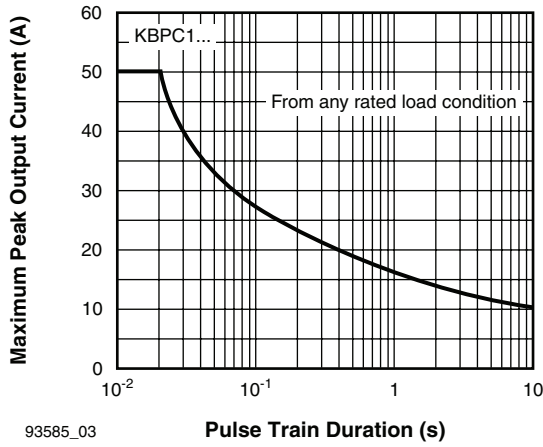

93585\_03

Pulse Train Duration (s)

Fig. 3 - Non-Repetitive Surge Ratings

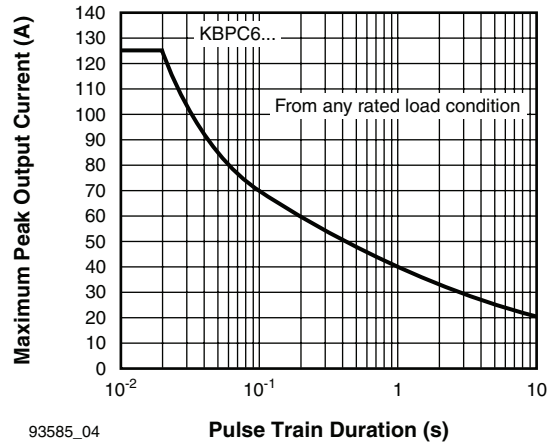

93585\_04

Pulse Train Duration (s)

Fig. 4 - Non-Repetitive Surge Ratings

## CIRCUIT CONFIGURATION

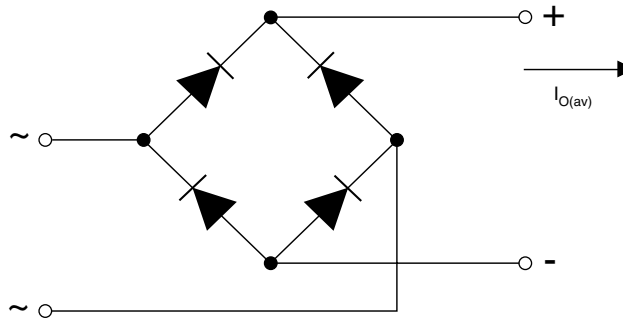

### LINKS TO RELATED DOCUMENTS

Dimensions

[www.vishay.com/doc?95250](http://www.vishay.com/doc?95250)

## D-72

**DIMENSIONS** in millimeters (inches)

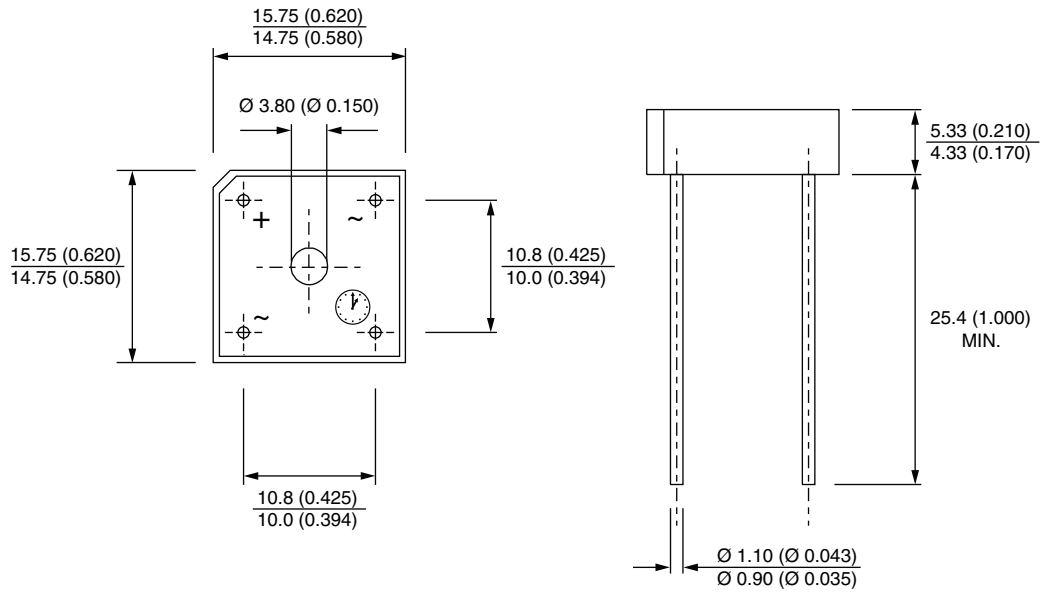



## **Disclaimer**

ALL PRODUCT, PRODUCT SPECIFICATIONS AND DATA ARE SUBJECT TO CHANGE WITHOUT NOTICE TO IMPROVE RELIABILITY, FUNCTION OR DESIGN OR OTHERWISE.

Vishay Intertechnology, Inc., its affiliates, agents, and employees, and all persons acting on its or their behalf (collectively, "Vishay"), disclaim any and all liability for any errors, inaccuracies or incompleteness contained in any datasheet or in any other disclosure relating to any product.

Vishay makes no warranty, representation or guarantee regarding the suitability of the products for any particular purpose or the continuing production of any product. To the maximum extent permitted by applicable law, Vishay disclaims (i) any and all liability arising out of the application or use of any product, (ii) any and all liability, including without limitation special, consequential or incidental damages, and (iii) any and all implied warranties, including warranties of fitness for particular purpose, non-infringement and merchantability.

Statements regarding the suitability of products for certain types of applications are based on Vishay's knowledge of typical requirements that are often placed on Vishay products in generic applications. Such statements are not binding statements about the suitability of products for a particular application. It is the customer's responsibility to validate that a particular product with the properties described in the product specification is suitable for use in a particular application. Parameters provided in datasheets and/or specifications may vary in different applications and performance may vary over time. All operating parameters, including typical parameters, must be validated for each customer application by the customer's technical experts. Product specifications do not expand or otherwise modify Vishay's terms and conditions of purchase, including but not limited to the warranty expressed therein.

Except as expressly indicated in writing, Vishay products are not designed for use in medical, life-saving, or life-sustaining applications or for any other application in which the failure of the Vishay product could result in personal injury or death. Customers using or selling Vishay products not expressly indicated for use in such applications do so at their own risk and agree to fully indemnify and hold Vishay and its distributors harmless from and against any and all claims, liabilities, expenses and damages arising or resulting in connection with such use or sale, including attorneys fees, even if such claim alleges that Vishay or its distributor was negligent regarding the design or manufacture of the part. Please contact authorized Vishay personnel to obtain written terms and conditions regarding products designed for such applications.

No license, express or implied, by estoppel or otherwise, to any intellectual property rights is granted by this document or by any conduct of Vishay. Product names and markings noted herein may be trademarks of their respective owners.

## **Material Category Policy**

**Vishay Intertechnology, Inc. hereby certifies that all its products that are identified as RoHS-Compliant fulfill the definitions and restrictions defined under Directive 2011/65/EU of The European Parliament and of the Council of June 8, 2011 on the restriction of the use of certain hazardous substances in electrical and electronic equipment (EEE) - recast, unless otherwise specified as non-compliant.**

**Please note that some Vishay documentation may still make reference to RoHS Directive 2002/95/EC. We confirm that all the products identified as being compliant to Directive 2002/95/EC conform to Directive 2011/65/EU.**